

CATALOGUE

SURGICAL INSTRUMENTS

Serving Your Health With Excellence





Buck
AS-1-102-18
Percussion Hammer
20cm,



Buck
AS-1-101-18
Percussion Hammer
18.5 cm,



Dejerine
AS-1-103-20
Percussion Hammer
20cm,



Dejerine
AS-1-104-21
Percussion Hammer
21cm,



Taylor Mod. USA
AS-1-105-20
Percussion Hammer
20cm,



Wartenberg
AS-1-106-19
Pinwheel
18cm,



Pinard
AS-1-107-18
Stethoscope
18 cm,



Pinard
AS-1-108-15
Stethoscope
15cm,



Magill
AS-2-101-15
Catheter Introducing Forceps
14.5 cm, 20 cm, 25 cm,



Miller
AS-2-102-00
Laryngoscope Sets



Miller-Baby
AS-2-103-00
Laryngoscope Sets



Miller
AS-2-104-00
Laryngoscope Blade
Fig. 0, Fig. 1, Fig. 2, Fig. 3, Fig. 4,



Guedel-Negus
AS-2-105-00
Laryngoscope Sets
Fig. 2, Fig. 3, Fig. 4,



Guedel-Negus
AS-2-106-00
Laryngoscope Sets Fig.
1, Fig. 2, Fig. 3, Fig. 4,



**Guedel-Negus
AS-2-107-01**

Laryngoscope Blades
Fig. 1, Fig. 2, Fig. 3, Fig. 4,



**McIntosh
AS-2-108-00**



**McIntosh
AS-2-109-00**

Laryngoscope Blades
Fig. 0, Fig. 1, Fig. 2, Fig. 3, Fig. 4,



**McIntosh
AS-2-110-00**

Laryngoscope Sets Fig.
1, Fig. 2, Fig. 3, Fig. 4,



**Foregger
AS-2-111-01**

Laryngoscope Blades
Fig. 1, Fig. 2, Fig. 3, Fig. 4,



**Battery Handle
AS-2-112-00**
Battery Handle



McIntosh
AS-2-114-00

Laryngoscope Sets fiber optic
Fig. 1, Fig. 2, Fig. 3,



McIntosh
AS-2-115-00

Laryngoscope Sets fiber optic
Fig. 1, Fig. 2, Fig. 3,



McIntosh
AS-2-116-00

Laryngoscope Sets fiber optic
Fig. 1, Fig. 2, Fig. 3,



McIntosh
AS-2-113-00

Laryngoscope Sets Fig.
1, Fig. 2, Fig. 3, Fig. 4,



Universal
AS-3-101-04
Trocar
14 cm,



Nelson
AS-3-102-07
Trocar
20 cm,



Lichtwitz
AS-3-103-19
Antrum Trocar
18.5 cm,



Adson
AS-3-104-21
Suction Cannula
20 cm,



Frazier
AS-3-105-10
Suction Cannula
24 cm,



Frazier
AS-3-106-06
Suction Cannula
19.5 cm,

Trocars



Poppen
AS-3-107-06
Suction Cannula
18 cm,



Luer
AS-3-108-30
Suction Tube working length 110 mm



Yasargil
AS-3-109-15
Suction Tube working length 150 mm with
Luer hub
21.5 cm,



Yankauer
AS-3-110-27
Suction Tube complete with suction tip and
connector
31 cm,



Yankauer
AS-3-111-00
Suction Tube
31 cm, 15 cm, 2.5 cm, 10 cm,



Poole
AS-3-112-22
Suction Tube
22 cm,



Poole
AS-3-113-22
Suction Tube
22.5 cm,



Nuboer
AS-3-114-21
Suction Tube
21 cm,



Nuboer
AS-3-115-21
Suction Tube
21 cm,



Quinke
AS-3-116-10
Lumbar Puncture Needle



Tuohy
AS-3-117-12
Lumbar Puncture Needle Luer Lock
connection with special tip



Verres
AS-3-118-20
Insufflation Cannula Luer Lock connection
15 cm,



Verres

AS-3-119-20

Insufflation Cannula Luer Lock connection
17 cm,



Kalt
AS-4-105-14
 Needle Holder
 13.5 cm,



Barraquer-Troutman
AS-4-106-10
 Micro Needle Holder
 10 cm, 10.5 cm,



Arruga
AS-4-107-14
 Micro Needle Holder
 13.5 cm,



Barraquer-Troutman
AS-4-108-10
 Micro Needle Holder
 10.5 cm, 11.5 cm,



Barraquer
AS-4-109-11
 Micro Needle Holder
 11.5 cm, 13.5 cm, 14 cm,



Barraquer
AS-4-110-13
 Micro Needle Holder
 13.5 cm,



Castroviejo-Fino
AS-4-111-01
Micro Needle Holder
13 cm,



Castroviejo-Fino
AS-4-112-01
Micro Needle Holder
13 cm,



Castroviejo-Fino
AS-4-113-01
very delicate jaw with lock
13 cm,



Castroviejo
AS-4-114-14
Micro Needle Holder with lock
14 cm,



Castroviejo
AS-4-115-14
Micro Needle Holder
14 cm,



Castroviejo
AS-4-121-14
Micro Needle Holder with lock
14 cm,



Castroviejo
AS-4-122-14
Micro Needle Holder
14 cm,



Castroviejo
AS-4-124-13
Micro Needle Holder with lock
12 cm,



Arruga
AS-4-123-16
Needle Holder delicate
16 cm,



Castroviejo
AS-4-125-12
Micro Needle Holder with lock
12 cm,



Derf
AS-4-126-12
Needle Holder
12 cm, 13 cm,

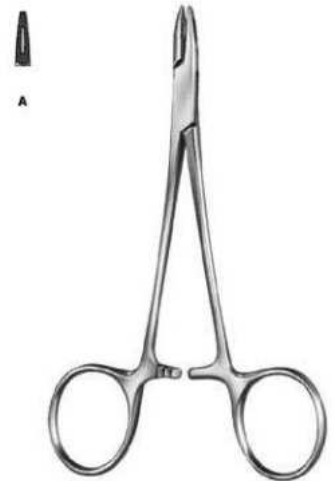

Collier
AS-4-127-12
Needle Holder
12.5 cm,



Webster
AS-4-128-13
Needle Holder
13 cm,



Halsey
AS-4-129-13
Needle Holder
13.5 cm,



Neivert
AS-4-130-13
Needle Holder
12.5 cm,



Hegar-Baumgartner
AS-4-131-14 Needle
Holder 14.5 cm,



Crile-Murray
AS-4-133-15
Needle Holder
15 cm,



Crile-Wood
AS-4-134-15
Needle Holder
15 cm,



Adson
AS-4-140-18
 Needle Holder one fenestrated jaw
 18 cm,



Metzenbaum
AS-4-141-18
 Needle Holder one grooved and fenestrated
 jaw
 18.5 cm,



M. G. Hospital
AS-4-142-17
 Needle Holder
 17.5 cm,

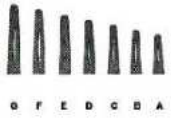

Mayo-Hegar
AS-4-143-14
 Needle Holder
 14.5 cm, 16 cm, 18.5 cm, 20.5 cm, 24 cm, 26.5
 cm,



Mayo-Hegar
AS-4-144-16
 Needle Holder
 16 cm, 18.5 cm, 20.5 cm,



Brown
AS-4-145-13
 Needle Holder
 13 cm, 18 cm,

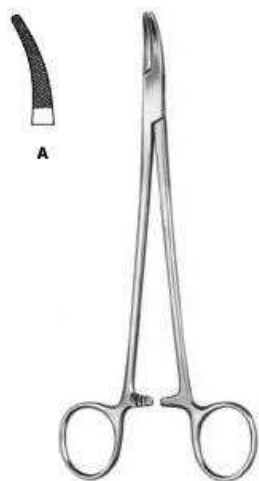

Heaney
AS-4-146-21
Needle Holder
20.5 cm,

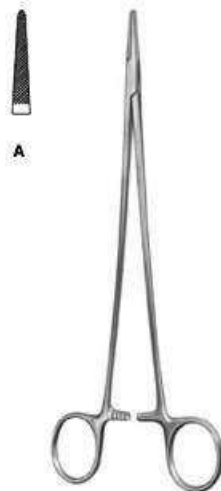

Jamison
AS-4-147-23
Needle Holder
23.5 cm,



Masson
AS-4-148-27
Needle Holder
26.5 cm,



Finochietto
AS-4-149-27
Needle Holder
26.5 cm,



Wangensteen
AS-4-150-27
Needle Holder
26.5 cm,

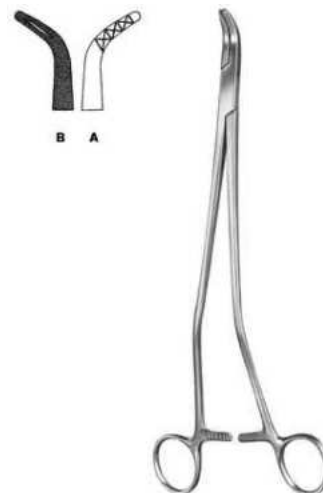

Johnson
AS-4-151-27
Needle Holder
27 cm,

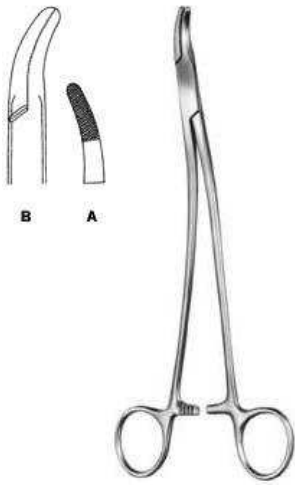

Stratte
AS-4-152-23
 Needle Holder
 23 cm,

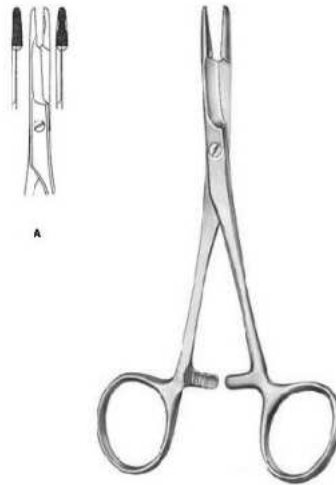

Olsen-Hegar
AS-4-153-14
 Needle Holder
 14 cm,

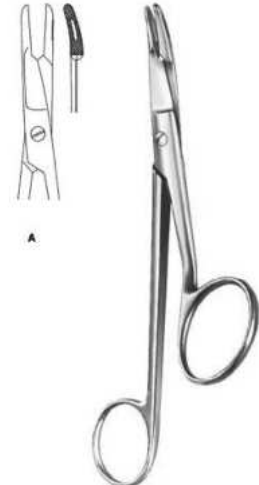

Gillies
AS-4-154-16
 Needle Holder
 16 cm,



Crile
AS-4-155-15
 Needle Holder
 15 cm,



Mathieu
AS-4-156-14
 Needle Holder
 14 cm, 17 cm, 20 cm,



Mathieu
AS-4-157-14
 Needle Holder
 14 cm, 16.5 cm,



Toennis
AS-4-158-18
 Needle Holder
 18.5 cm,



Lichtenberg
AS-4-159-20
 Needle Holder
 20 cm,



AS-4-160-16
 Micro Needle Holder
 16 cm,



AS-4-161
 Micro Needle Holder
 23 cm, 19 cm,



Hepp-Scheidel
AS-4-162-18
 Micro Needle Holder smooth jaw
 18 cm,

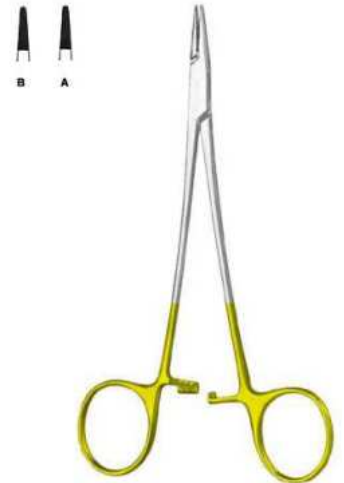

Webster
AS-4-163-13
 Needle Holder with automatic release ratchet
 also for lefthanders
 13 cm, 15 cm,



AS-4-164-15

Micro Needle Holder
15 cm, 18 cm, 21 cm, 23 cm,



JABOMA

AS-4-165-18

Micro Needle Holder
18 cm,



Castroviejo

AS-4-166

Micro Needle Holder
14.5 cm, 18 cm, 21.5 cm,



Arruga

AS-4-167

Needle Holder
16 cm,



Castroviejo

AS-4-168-13

Micro Needle Holder
12.5 cm,



Barraquer

AS-4-169-13

Micro Needle Holder
13 cm,



Barraquer
AS-4-170-13
 Micro Needle Holder
 13 cm,



Webster
AS-4-171-13
 Needle Holder
 13 cm,

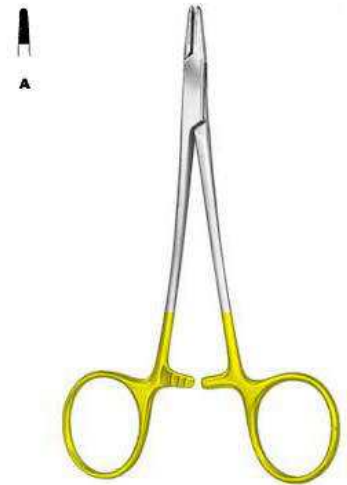

Derf
AS-4-173-12
 Needle Holder
 12 cm,

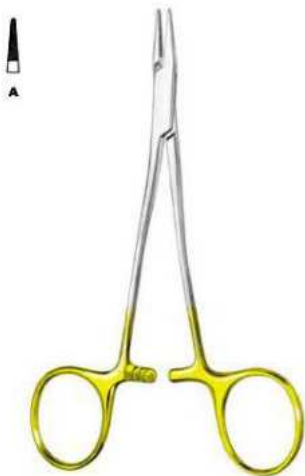

Kilner
AS-4-172-13
 Needle Holder
 13 cm,



Hegar-Baumgartner
AS-4-174-13 Needle
 Holder
 13 cm, 14.5 cm,



Halsey
AS-4-175-12
 Needle Holder
 13 cm, 12 cm,



Crile-Wood
AS-4-176-15
 Needle Holder
 15 cm,



Sarot
AS-4-177-18
 Needle Holder
 18 cm, 20 cm, 26 cm,

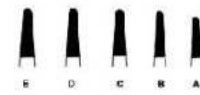

Mayo-Hegar
AS-4-178-16
 Needle Holder standard profile
 16 cm, 18 cm, 20 cm, 24 cm, 26 cm, 30 cm,



Heaney
AS-4-179-20
 Needle Holder
 20 cm, 24 cm, 26 cm,



DeBakey
AS-4-180-18
 Needle Holder delicate pattern mini profile
 18 cm, 20 cm, 23 cm, 26 cm, 31 cm,



Masson
AS-4-181-27
 Needle Holder
 26.5 cm,



Ryder (Martin)
AS-4-182-13

Needle Holder

12.5 cm, 15 cm, 18 cm, 20 cm, 23 cm, 26 cm,



Martin

AS-4-183-15

Needle Holder mini profile elastic type
15 cm, 17 cm, 20 cm,



Wangensteen

AS-4-184-27

Needle Holder standard profile
27 cm,



Hegar-Vascular

AS-4-185-14

Needle Holder micro profile
14 cm, 18.5 cm, 20.5 cm, 23 cm,

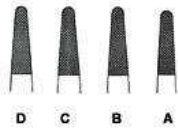

Bozemann

AS-4-186-20

Needle Holder standard profile
20.5 cm, 24 cm, 26.5 cm, 29 cm,



Hegar

AS-4-187-20

Needle Holder standard profile
20 cm, 23.5 cm,



Stratte
AS-4-188-22
 Needle Holder standard profile
 23 cm,



Microvascular
AS-4-189-00
 Needle Holder slender pattern micro profile
 14 cm, 17.5 cm, 20 cm, 23 cm,



Mathieu
AS-4-190-14
 Needle Holder
 14 cm, 17 cm, 20 cm,



Mathieu
AS-4-191-14
 Needle Holder
 14 cm, 17 cm, 20 cm,



Mathieu
AS-4-192-17
 Needle Holder standard profile with interior
 ratchet
 17 cm, 20 cm, 23 cm,



Toennis
AS-4-193-18
 Needle Holder
 18.5 cm,



Lichtenberg
AS-4-194-20

Needle Holder lightweight model standard profile
20 cm,



Langenbeck
AS-4-195-18

Needle Holder
18 cm, 20.5 cm, 23 cm,



Zweifel
AS-4-196-20

Needle Holder with hinged ratchet standard profile
20.5 cm, 23 cm,



Reverdin
AS-4-197-15

Reverdin Needle short
14.5 cm Fig. 1, 14.5 cm Fig. 2, 14.5 cm Fig. 3, 14.5 cm Fig. 4,

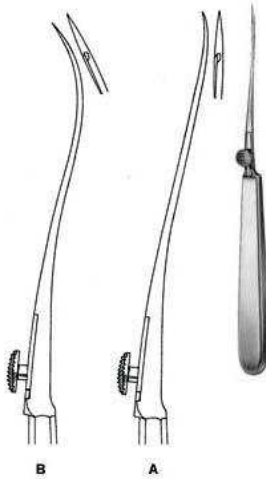

Reverdin
AS-4-198-19

Reverdin Needle medium
19.5 cm Fig. 1, 19.5 cm Fig. 2, 19.5 cm Fig. 3, 19.5 cm Fig. 4,

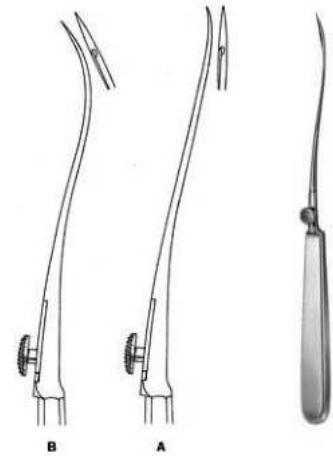

Reverdin
AS-4-199-23

Reverdin Needle long
23 cm Fig. 1, 23 cm Fig. 2, 23 cm Fig. 3, 23 cm Fig. 4,



Schmieden-Dick
AS-4-201-01
 Ligature Needle malleable
 29 cm,

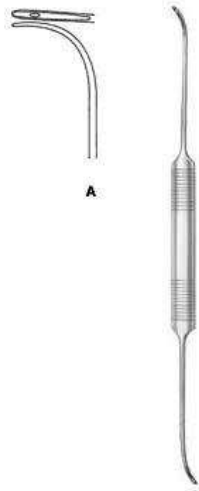

Schmieden
AS-4-202-21
 Ligature Needle
 24 cm,



AS-4-203-20
 Ligature Needle malleable
 20.5 cm,

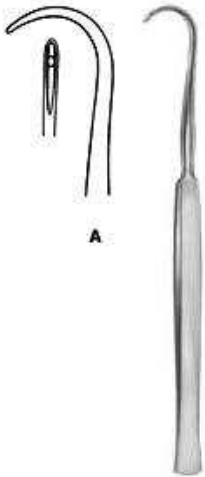

Cooper
AS-4-204-19
 Ligature Needle
 18.5 cm,



Kronecker
AS-4-205-13
 Ligature Needle delicate for right hand
 12.5 cm,

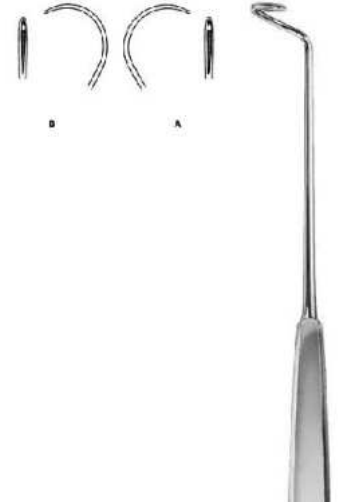

Deschamps
AS-4-206-24
 Ligature Needle blunt for right hand
 24 cm,



Deschamps
AS-4-207-20
Ligature Needle blunt for right hand
20 cm,



Deschamps
AS-4-208-20
Ligature Needle sharp for right hand
20 cm,

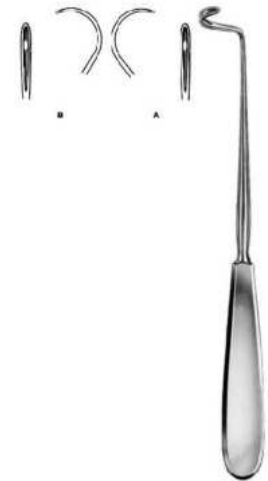

Deschamps
AS-4-209-21
Ligature Needle blunt for right hand
20 cm,



Deschamps
AS-4-210-21
Ligature Needle sharp for right hand
20 cm,

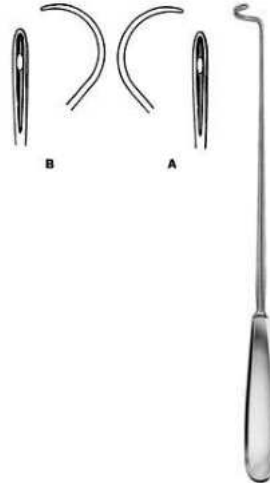

Deschamps
AS-4-211-27
Ligature Needle blunt for right hand
27 cm,

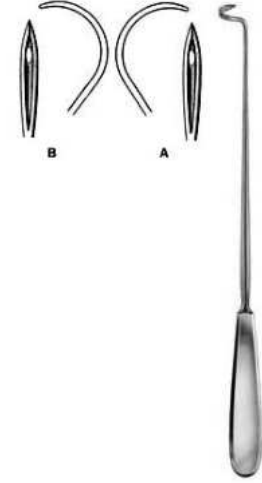

Deschamps
AS-4-212-27
Ligature Needle sharp for right hand
27 cm,

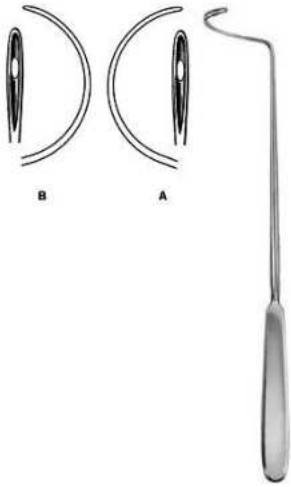

Deschamps
AS-4-213-28

Ligature Needle blunt for right hand
28 cm,



Deschamps
AS-4-214-20

Ligature Needle sharp for right hand
20 cm,



Deschamps
AS-4-215-20

Ligature Needle blunt for right hand
20 cm,



Deschamps
AS-4-216-20

Ligature Needle blunt for right hand
21 cm,

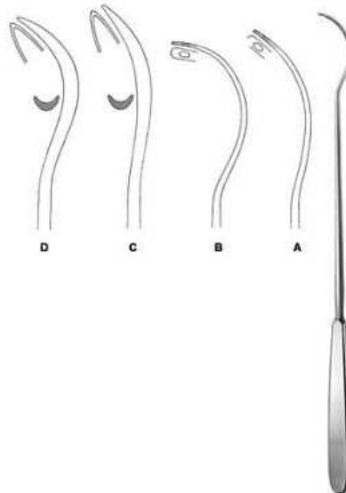

Brunner
AS-4-217-30
Ligature Needle
21 cm,



Kirschner
AS-4-218-25
Ligature Conductor
25.5 cm,



AS-4-219-28
Ligature Conductor
28 cm,



Modell Wien
AS-4-220-23
Ligature Catcher
23.5 cm,



Michel
AS-4-221-12
Clip Applying Forceps
12 cm,



Hegenbarth
AS-4-222-12
Clip Applying Forceps
12 cm,

Scalpels



AS-5-101-01

Dissecting Knife with metal handle
15 cm, 15.5 cm, 16 cm, 17 cm,



AS-5-102-10

Autopsy Knife
25.5 cm,

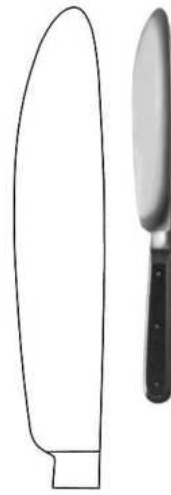

Walb

AS-5-104-17 Post
Mortem Knife

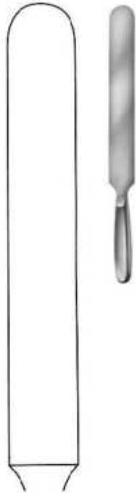

Virchow

AS-5-105-20

Brain Knife with hollow handle
28.5 cm, 33.5 cm, 38 cm,



AS-5-108-04

Scalpel Handle solid
13.5 cm,



AS-5-109-34

Scalpel Handle
16 cm,

Scalpels



AS-5-110-41
Scalpel Handle solid, long
21 cm,



AS-5-111-45
Scalpel Handle
21 cm,



Collin
AS-5-112-08
Scalpel Handle with hollow handle
13.5 cm,



Collin
AS-5-113-09
Scalpel Handle with hollow handle
14.5 cm,



AS-5-114-03
Scalpel Handle solid
12 cm,



AS-5-115-04
Scalpel Handle
12 cm,



AS-5-116-05
Scalpel Handle
12 cm,



AS-5-117-31
Scalpel Handle solid, long
21.5 cm,



AS-5-118-35
Scalpel Handle
21 cm,



AS-5-119-07
Scalpel Handle solid
16 cm,



AS-5-120-71
Scalpel Handle solid short
12.5 cm,



AS-5-121-03
Scalpel Handle with round hollow handle
15.5 cm,



AS-5-127-16

Amputation Knife with hollow handle
29 cm,



AS-5-128-19

Amputation Knife with hollow handle
32.5 cm,



Catlin

AS-5-129-16

Interosseous Knife with hollow handle
29cm,



AS-5-130-06

Resection Knife solid handle, dissecting end
18 cm,



Langenbeck

AS-5-131-05

Resection Knife
18 cm,



Langenbeck

AS-5-132-05

Resection Knife
18 cm,



AS-5-133-00

Razor Knife hollow blades on both sides cutting length 75mm



Schink

AS-5-134-00

Dermatome complete with 2 skin fixing plates and one blade 31 cm,



Schink

AS-5-135-01

Spare Blade spare blade for KE-05-134-00



Schink

AS-5-136-02

Skin Fixing Plate for KE-05-134-00



Standard BL / BL Straight
AS-5-201-13

Operating Scissor Special Price: \$1.25
12 cm, 13 cm, 14.5 cm, 16.5 cm, 18.5 cm, 20.5 cm,



Standard SH / BL STR
AS-5-202-13

Operating Scissors
12 cm, 13 cm, 14.5 cm, 16.5 cm, 18.5 cm, 20.5 cm,



Standard SH / SH STR
AS-5-204-13

Operating Scissors
12 cm, 13 cm, 14.5 cm, 16.5 cm,



Standard BL / BL Curved
AS-5-205-13

Operating Scissors
12 cm, 13 cm, 14.5 cm, 16.5 cm, 18.5 cm, 20.5 cm,



Standard SH / BL Curved
AS-5-206-13

Operating Scissors
12 cm, 13 cm, 14.5 cm, 16.5 cm, 18.5 cm, 20.5 cm,



Standard SH / SH Curved
AS-5-207-13

Operating Scissors
12 cm, 13 cm, 14.5 cm, 16.5 cm,



Standard BL / BL Curved
AS-5-208-14
Operating Scissors delicate
14.5 cm,



Incision Scissor
AS-5-209-14
Operating Scissor
14.5 cm,



Deaver
AS-5-210-14
Operating Scissors



Mayo
AS-5-211-15
Dissecting Scissors
14.5 cm, 15 cm, 17 cm, 23.5 cm, 14.5 cm, 15
cm, 17 cm, 23.5 cm,



Mayo
AS-5-212-23
Dissecting Scissors
23 cm, 22.5 cm, 28 cm,



Mayo-Harrington
AS-5-213-22
Dissecting Scissors
23 cm, 22.5 cm, 28 cm,

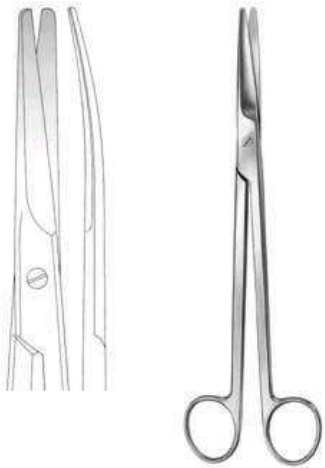

Mayo-Harrington
AS-5-214-22 Dissecting
 Scissors cur. 22.5
 cm, 28 cm, 23 cm,

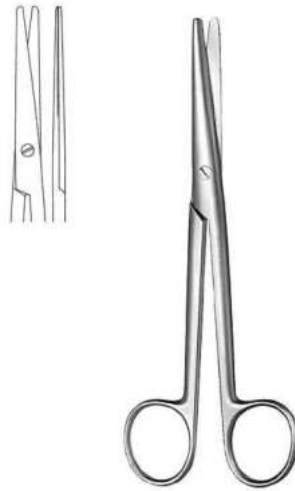

Mayo-Stille
AS-5-215-17
 Dissecting Scissors str.
 15 cm, 17 cm,

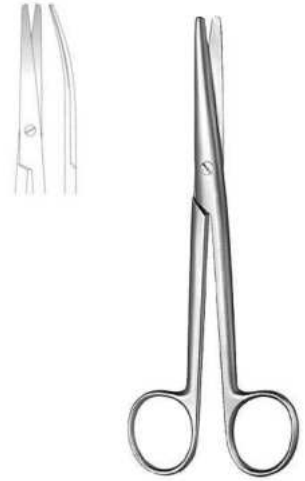

Mayo-Stille
AS-5-216-15 Dissecting
 Scissors cur. 15 cm, 17
 cm,

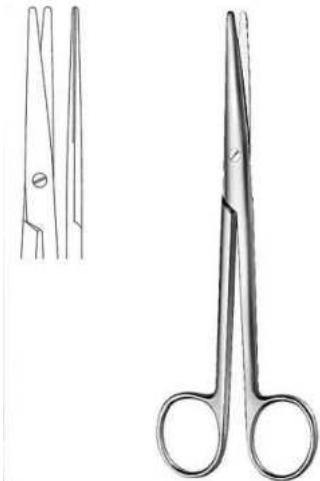

Mayo-Stille
AS-5-217-19
 Dissecting Scissors str.
 16 cm, 19.5 cm, 21.5 cm,

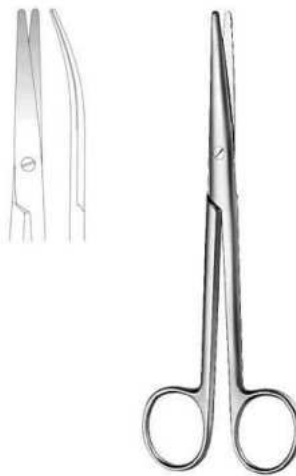

Mayo-Stille
AS-5-218-16
 Dissecting Scissors cur.
 16 cm, 19.5 cm, 21.5 cm,



Mayo-Noble
AS-5-219-17
 Gynecological Scissors
 16.5 cm,



Sims

AS-5-220-23

Gynecological Scissors str.
20 cm, 23 cm,



Sims

AS-5-221-20

Gynecological
Scissors cur. 20 cm, 23 cm,



Kelly

AS-5-222-16

Operating Scissors
16 cm,



Doyen

AS-5-223-17

Gynecological Scissors
18.5 cm,



Sims-Siebold

AS-5-224-24

Gynecological Scissors
24.5 cm,



Sims-Siebold

AS-5-225-24

Gynecological Scissors
24.5 cm,



Wertheim
AS-5-226-23
Gynecological Scissors
20 cm, 23 cm,



Metzenbaum
AS-5-227-11
Dissecting Scissors
11.5 cm,



Metzenbaum
AS-5-228-14
Dissecting Scissors
14.5 cm,



Metzenbaum
AS-5-229-15
Dissecting Scissors
15.5 cm,



Metzenbaum-Nelson
AS-5-230-20
Dissecting Scissors
18 cm, 20.5 cm, 23 cm, 26 cm, 28.5 cm, 31 cm,



Metzenbaum-Nelson
AS-5-231-20
Dissecting Scissors
18 cm, 20.5 cm,



Metzenbaum-Nelson
AS-5-232-20

Dissecting Scissors

18 cm, 20.5 cm, 23 cm, 26 cm, 28.5 cm, 31 cm,



Metzenbaum
AS-5-233-14

Dissecting Scissors toothed

14.5 cm,



Nerve Operating Scissor
AS-5-234-15

Dissecting Scissors

15.5 cm,

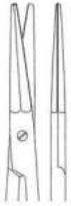

Gorney

AS-5-235-19

Face-lift Scissors str.

12.5 cm, 19.5 cm,

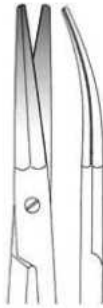

Gorney

AS-5-236-19

Face-lift Scissors cur.

19.5 cm,



Aston

AS-5-237-17

Face-lift Scissors

17 cm,



Lexer
AS-5-238-16
Dissecting Scissors
16 cm,



Cinelli
AS-5-239-14
Nasal Scissors
11.5 cm, 14 cm,



Thorek
AS-5-240-19
Dissecting Scissors
18.5 cm,



Lexer-Baby
AS-5-241-10
Dissecting Scissors
10 cm,



Lexer-Fino
AS-5-242-16
Delicate Dissecting Scissors slender pattern
16.5 cm,



Metzenbaum-Fino
AS-5-243-14
Delicate Dissecting Scissors slender pattern
14.5 cm,



Metzenbaum-Fino
AS-5-244-14
Delicate Dissecting Scissors
14.5 cm,



Metzenbaum-Fino
AS-5-245-14
Delicate Dissecting Scissors
14.5 cm,



Metzenbaum-Fino
AS-5-246-14
Delicate Dissecting Scissors
14.5 cm,

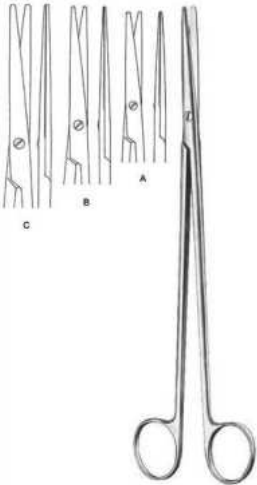

Metzenbaum-Fino
AS-5-247-18
Delicate Dissecting Scissors slender pattern
18 cm,20 cm,23 cm,

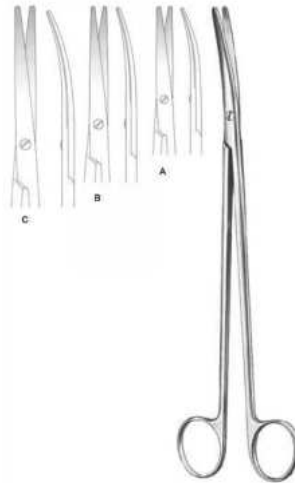

Metzenbaum-Fino
AS-5-248-18
Delicate Dissecting Scissors slender pattern
18 cm,20 cm,23 cm,

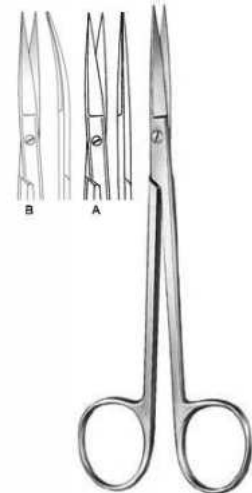

Sanvenero
AS-5-250-14
Operating Scissors
14 cm,

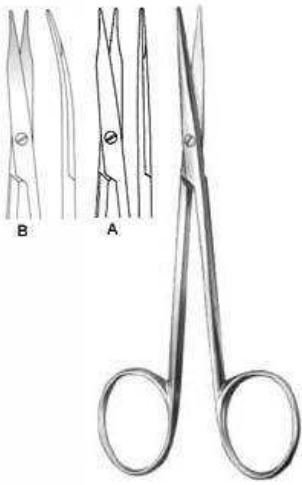

AS-5-251-11
Fine Operating Scissors
11.5 cm,

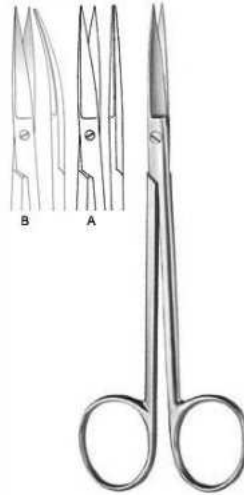

Joseph
AS-5-252-14
Operating Scissors
14.5 cm,

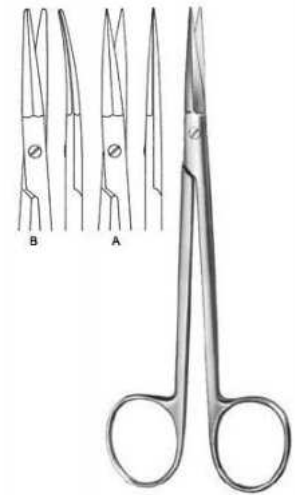

Peck-Joseph
AS-5-253-14
Face-lift Scissors
14.5 cm,

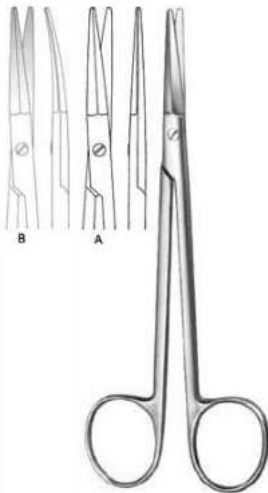

Peck-Joseph
AS-5-254-14
Face-lift Scissors
14.5 cm,



Shea Vein Graft
AS-5-255-12
Dissecting Scissors
12 cm,

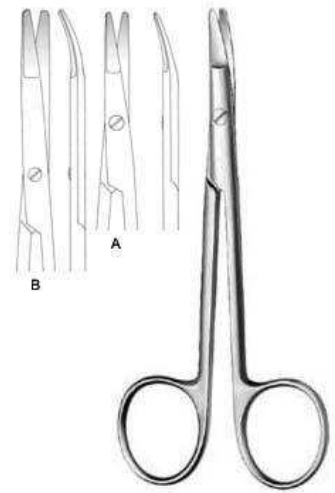

Kilner
AS-5-256-12
Dissecting Scissors
12 cm, 15 cm,

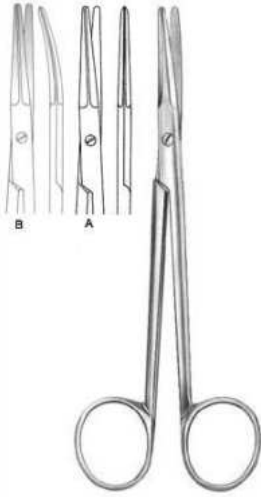

AS-5-257-14
Dissecting Scissors
14.5 cm,

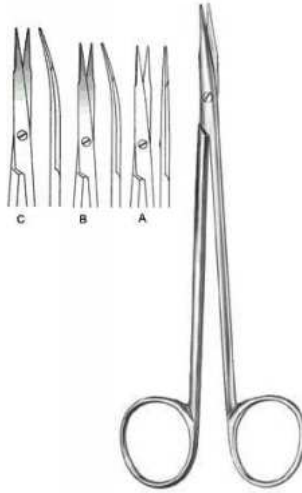

Reynolds
AS-5-258-15
Dissecting Scissors
15.5 cm, 18 cm,



Jameson
AS-5-259-14
Dissecting Scissors
15.5 cm,



Jameson
AS-5-260-14
Dissecting Scissors
15.5 cm,



AS-5-261-19
Vascular Scissors
19 cm,

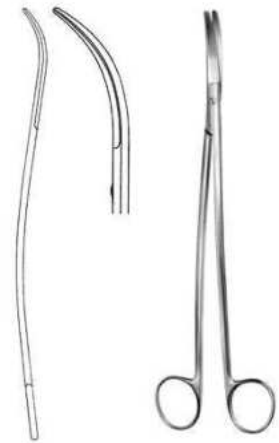

AS-5-262-24
Vascular Scissors fine, short blades
19 cm, 25.5 cm,

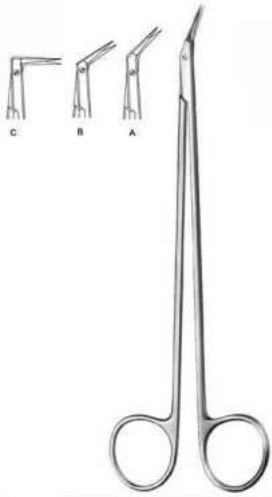

Diethrich

AS-5-263-25

Vascular Scissors
19 cm, 18.5 cm, 17.5 cm,

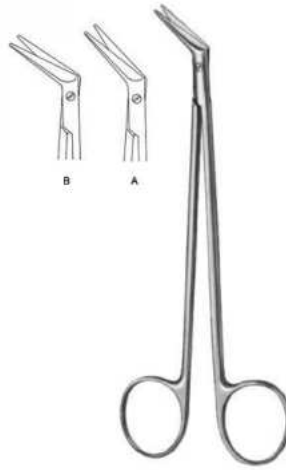

DeBakey

AS-5-264-45

Vascular Scissors
16.5 cm, 16 cm,



Potts-Smith

AS-5-265-19 Vascular

Scissors 18 cm, 18.5
cm, 19 cm,



Coronary Scissors

AS-5-266-25

Cardiovascular Surgery Scissor
18 cm,



Coronary Scissors

AS-5-267-45

Cardiovascular Surgery Scissors
18 cm,



Coronary Scissors

AS-5-268-60

Cardiovascular Surgery Scissor
18 cm,



Coronary Scissors
AS-5-269-90
Cardiovascular Surgery Scissor
18 cm,



Coronary Scissors
AS-5-270-00
Cardiovascular Surgery Scissor
18 cm,



Coronary Scissors
AS-5-271-00
Cardiovascular Surgery Scissor
18 cm,



Coronary Scissors
AS-5-272-25
Cardiovascular Surgery Scissor
18 cm,



Coronary Scissors
AS-5-273-45
Cardiovascular Surgery Scissor
18 cm,



Coronary Scissors
AS-5-274-90
Cardiovascular Surgery Scissor
18 cm,



Schmieden-Taylor
AS-5-275-17 Dura
Scissors
15 cm,



Strully
AS-5-276-22
Neurosurgical Scissors
22.5 cm,



Toennis-Adson
AS-5-277-17
Dissecting Scissors
17.5 cm,



Good
AS-5-279-19
Tonsil Scissors
19.5 cm,



Fomon
AS-5-282-15
Nasal Scissors
15 cm,



Cottle
AS-5-283-16
Nasal Scissors
16 cm,



Heymann
AS-5-284-18
Nasal Scissors
18.5 cm,



Heymann
AS-5-285-18
Nasal Scissors
18.5 cm,



Converse
AS-5-286-11
Nasal Scissors blunt & sharp
10.5 cm,



Waldmann
AS-5-287-18
Episiotomy Scissors
18 cm,



Braun-Stadler
AS-5-288-14
Episiotomy Scissors
14.5 cm,



Braun-Stadler
AS-5-289-22
Episiotomy Scissors
22 cm,



Modell USA
AS-5-290-10
Umbilical Scissors
10.5 cm,



Busch
AS-5-292-16
Umbilical Scissors
16 cm,



Goldmann-Fox
AS-5-293-13
Gum Scissors
13 cm,



Wagner
AS-5-294-12
Operating Scissors
12 cm,

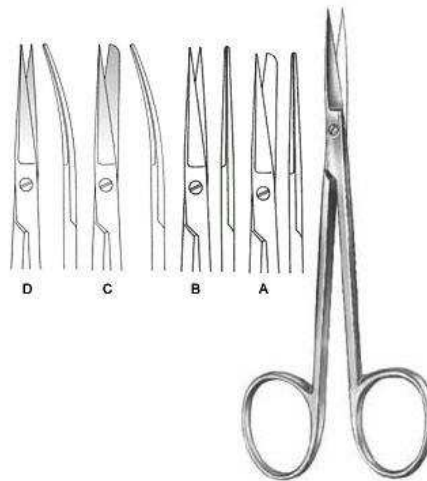

AS-5-295-12
Operating Scissors small model
12 cm,



La Grange
AS-5-296-11
Gum Scissors S-shaped
11.5 cm,



AS-5-297-11
Dissecting Scissors delicate
11.5 cm,



Locklin
AS-5-298-16
Gum Scissors
16 cm,



Locklin
AS-5-299-16
Gum Scissors
16 cm,



AS-5-300-08
Operating Scissors very delicate
9 cm,

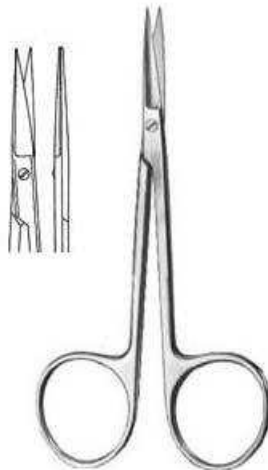

AS-5-301-10
Iris Scissors
9 cm, 10 cm,

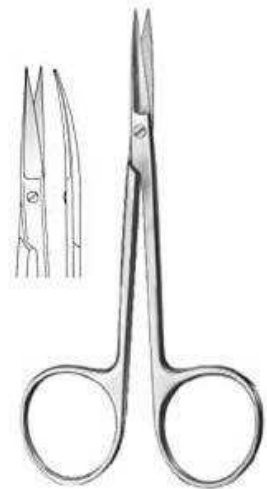

AS-5-302-10
Iris Scissors extra flat blades
10 cm,



AS-5-303-10
Iris Scissors extra flat blades
10 cm,



Bonn
AS-5-304-09
Iris Scissors



Dean
AS-5-278-17
Tonsil Scissors
17.5 cm,



Spencer Scissor
AS-0-

Dressing & Tissue Forceps



Standard

AS-5-401-10

Dressing Forceps

10.5 cm, 11.5 cm, 13 cm, 14.5 cm, 16 cm, 18 cm, 20 cm, 23 cm, 25 cm, 30.5 cm,



Standard

AS-5-402-11

Dressing Forceps

12 cm, 13 cm, 14.5 cm, 16 cm, 18 cm, 20 cm, 25 cm, 30 cm,



AS-5-403-13

Dressing Forceps

13 cm, 14.5 cm,



Stille

AS-5-404-15

Dressing Forceps

15 cm,



Mini-Adson

AS-5-405-12

Dressing Forceps

12 cm,



Adson

AS-5-406-12

Dressing Forceps

12 cm, 15 cm,

Dressing & Tissue Forceps



McIndoe
AS-5-407-15
Dressing Forceps
15 cm,



Waugh
AS-5-408-20
Dressing Forceps
20 cm,



Semken
AS-5-409-12
Dressing Forceps
12.5 cm, 15 cm,



Taylor
AS-5-410-17
Dressing Forceps
12.5 cm, 15 cm,



Taylor
AS-5-411-17
Dressing Forceps
17 cm,



Taylor
AS-5-412-17
Dressing Forceps
18.5 cm,

Dressing & Tissue Forceps



AS-5-413-06
Micro Dressing Forceps
15.5 cm,



Gerald
AS-5-414-18
Dressing Forceps
15.5 cm,



Cushing
AS-5-415-17
Dressing Forceps
17.5 cm,



Potts-Smith
AS-5-416-18
Dressing Forceps 18
cm, 21 cm, 24.5 cm,



Bonney
AS-5-417-17
Dissecting Forceps
17.5 cm,



Gerald
AS-5-418-17
Dissecting Forceps
17.5 cm,

Dressing & Tissue Forceps



Gillies
AS-5-419-15
Dissecting Forceps
15.5 cm,



McIndoe
AS-5-420-15
Dressing Forceps
15 cm,



Semken
AS-5-421-16
Dissecting Forceps
15.5 cm, 17.5 cm,



Adson-Brown
AS-5-422-12
Dissecting Forceps
12 cm,



Adson
AS-5-423-12
Dissecting Forceps
12 cm, 15 cm,



Adson
AS-5-424-12
Dressing Forceps
12 cm, 15 cm,

Dressing & Tissue Forceps



Cushing
AS-5-425-17
 Dressing Forceps
 17.5 cm,



Cushing
AS-5-426-18
 Dressing Forceps
 17 cm,



Cushing-Taylor
AS-5-427-18
 Dressing Forceps
 18.5 cm,

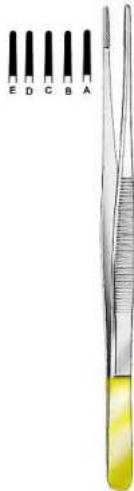

Potts-Smith
AS-5-428-15
 Dressing Forceps
 16 cm, 18.5 cm, 20 cm, 23 cm, 25 cm,



Oehler
AS-5-429-14
 Dissecting Forceps
 14.5 cm, 16 cm, 18 cm, 20 cm, 25 cm,



Wangensteen
AS-5-430-15
 Dressing Forceps
 15 cm, 23 cm,

Dressing & Tissue Forceps



DeBakey

AS-5-431-15

Atraumatic Dressing Forceps

16 cm, 20 cm, 24.5 cm, 16 cm, 20 cm, 24.5 cm,



DeBakey

AS-5-432-16

Atraumatic Dressing Forceps

16 cm, 20 cm, 24 cm,



AS-5-433-10

Dissecting Forceps

10.5 cm, 11.5 cm, 13 cm, 14.5 cm, 16 cm, 18 cm, 20 cm, 23 cm, 25 cm, 30.5 cm,

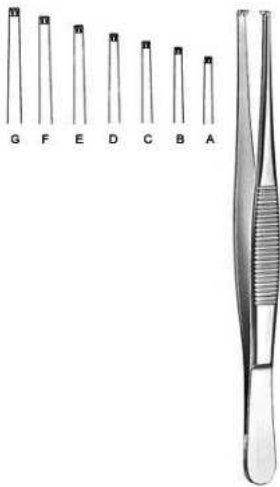

AS-5-434-11

Dissecting Forceps

12 cm, 13 cm, 14.5 cm, 15.5 cm, 18 cm, 20 cm, 24.5 cm,



AS-5-435-14

Dissecting Forceps

14.5 cm, 16 cm,



AS-5-436-14

Dissecting Forceps

14.5 cm, 16 cm,

Dressing & Tissue Forceps



AS-5-437-13
Dissecting Forceps
13 cm, 14.5 cm, 16 cm, 20 cm,



AS-5-438-13
Dissecting Forceps
13 cm, 14.5 cm,



Stille
AS-5-439-15
Dissecting Forceps
15 cm,



Stille
AS-5-440-15
Dissecting Forceps
15 cm,



Stone
AS-5-441-15
Dissecting Forceps
15 cm,



Lerche
AS-5-442-15
Dissecting Forceps
15 cm,

Dressing & Tissue Forceps



Adlerkreutz
AS-5-443-15

Dissecting Forceps
15.5 cm, 20.5 cm, 16 cm, 20 cm, 25 cm,

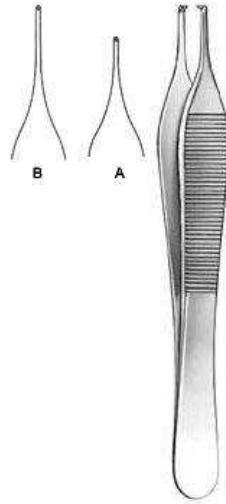

Adson
AS-5-444-12

Dissecting Forceps
12 cm, 15 cm,



Gillies
AS-5-445-15

Dissecting Forceps
15.5 cm,



Waugh
AS-5-446-20

Dissecting Forceps
20.5 cm,



Semken
AS-5-447-12

Dissecting Forceps
12.5 cm, 15 cm,



Taylor
AS-5-448-17

Dissecting Forceps
17.5 cm,

Dressing & Tissue Forceps



Taylor
AS-5-449-17
Dissecting Forceps
17 cm,



Taylor
AS-5-450-17
Dissecting Forceps
18.5 cm,



AS-5-451-06
Micro Dissecting Forceps
15.5 cm,



Gerald
AS-5-452-17
Dissecting Forceps
17.5 cm,



Cushing
AS-5-453-17
Dissecting Forceps
18 cm,



Potts-Smith
AS-5-454-18
Dissecting Forceps
18 cm, 21 cm, 24 cm,

Dressing & Tissue Forceps

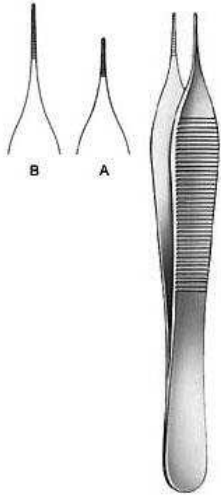

Mikro-Adson
AS-5-455-12
Dressing Forceps
12 cm, 15 cm,

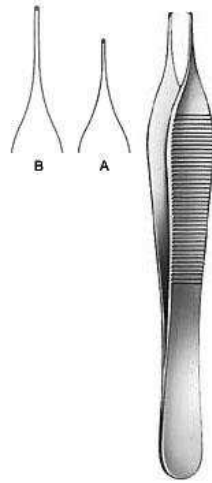

Mikro-Adson
AS-5-456-12
Dissecting Forceps
12 cm, 15 cm,



AS-5-457-11
Dissecting Forceps
10.5 cm,



Micro Jewelers
AS-5-458-12 Jeweler
Type Forceps 12 cm
Fig. 7,



Jewelers
AS-5-459-12 Jeweler
Type Forceps 12 cm
Fig. 3,



Jewelers
AS-5-460-11 Jeweler
Type Forceps 11 cm
Fig. 3c,

Dressing & Tissue Forceps



Jewelers
AS-5-461-11 Jeweler
Type Forceps 11 cm
Fig. 5,



Jewelers
AS-5-462-11 Jeweler
Type Forceps 11 cm
Fig. 4,



Stille-Barraya
AS-5-463-18
Dissecting Forceps
18 cm,



Bonney
AS-5-464-18
Dissecting Forceps
17.5 cm,



Nelson
AS-5-465-23
Dissecting Forceps
23 cm,



AS-5-466-10
Dressing Forceps
10 cm, 9.5 cm,

Dressing & Tissue Forceps



AS-5-467-12
Splinter Forceps smooth jaw
12.5 cm,



AS-5-468-12
Splinter Forceps smooth jaw
12.5 cm,



AS-5-469-12
Splinter Forceps
12.5 cm,



AS-5-470-12
Splinter Forceps
12.5 cm,



AS-5-471-16
Micro Tying Forceps
15.5 cm,



AS-5-472-10
Microscopic Forceps super light, blunt
10 cm,

Dressing & Tissue Forceps



AS-5-473-10
Microscopic Forceps
10 cm,



Shaaf
AS-5-474-09
Splinter Forceps
9.5 cm,



Littauer
AS-5-475-08
Cilia Forceps
8.5 cm,



AS-5-476-09
Cilia Forceps
8.5 cm,



Douglas
AS-5-477-09
Cilia Forceps
9 cm,



Douglas
AS-5-478-09
Cilia Forceps
9 cm,



Beer
AS-5-479-09
Cilia Forceps
9 cm,

Splinter Forceps



Phaneuf
AS-5-501-21
Hysterectomy Forceps
20.5 cm,



Wertheim-Cullen
AS-5-502-21
Vaginal Clamp 21
cm,

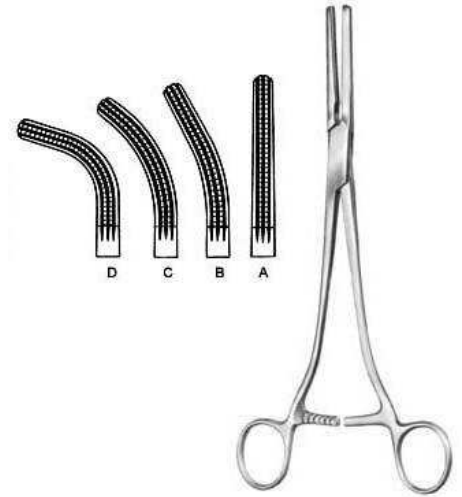

Rogers
AS-5-503-10
Hysterectomy Forceps
21.5 cm Fig. 1, 21 cm Fig. 2, 20.5 cm Fig. 3, 20
cm Fig. 4,



Moynihan
AS-5-504-23
Hysterectomy Forceps
23 cm,



Moynihan
AS-5-505-24
Hysterectomy Forceps
23.5 cm,



Wertheim
AS-5-506-25
Hysterectomy Forceps
26 cm,

Splinter Forceps

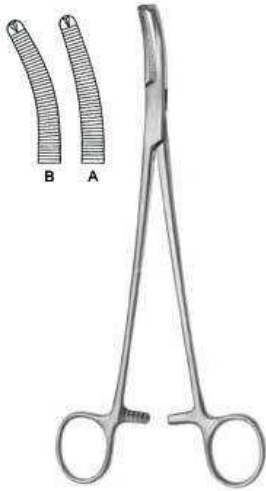

Wertheim
AS-5-507-22
Hysterectomy Forceps
22.5 cm,



Mikulicz, Baby
AS-5-508-14
Peritoneum Forceps
14.5 cm,



Mikulicz
AS-5-509-18
Peritoneum Forceps
20.5 cm,



Mikulicz
AS-5-510-20
Peritoneum Forceps
18.5 cm,



Mikulicz
AS-5-511-20
Peritoneum Forceps
20 cm,



Mikulicz
AS-5-512-21
Peritoneum Forceps
20.5 cm,



Faure
AS-5-513-20
Peritoneum Forceps
21 cm,

Haemostatic Forceps



Pean
AS-5-601-14
 Haemostatic Forceps
 14.5 cm, 16 cm,

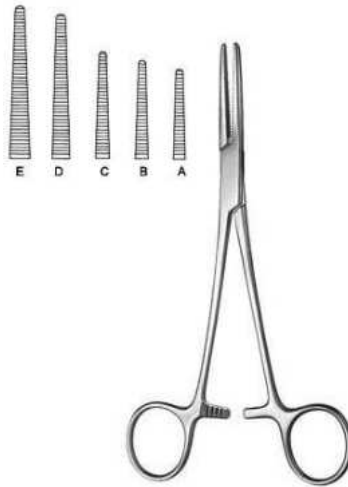

Spencer-Wells
AS-5-602-13
 Haemostatic Forceps
 13 cm, 14 cm, 15.5 cm, 18.5 cm, 20 cm,

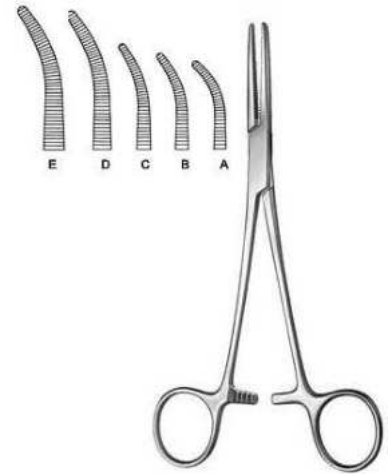

Spencer-Wells
AS-5-603-13
 Haemostatic Forceps
 13 cm, 14 cm, 15 cm, 18 cm, 20 cm,



Chaput
AS-5-604-13
 Haemostatic Forceps
 12.5 cm,



Tuffier
AS-5-605-13
 Haemostatic Forceps
 12.5 cm,

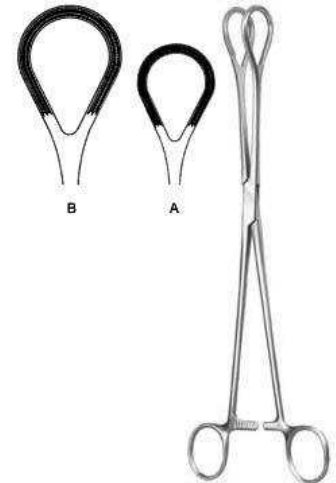

AS-5-606-25
 Organ Grasping Forceps

Haemostatic Forceps



Collin
AS-5-607-14
Organ Grasping Forceps
15.5 cm, 21 cm,



Collin
AS-5-608-17
Tumor Grasping Forceps
17 cm,



Pennington
AS-5-609-15
Haemostatic Forceps
15.5 cm,



Pratt
AS-5-610-15
Haemostatic Forceps
15 cm,



Martel-Rees
AS-5-611-14
Face-lift Forceps
13.5 cm,



AS-5-612-12
Ligature Forceps

Haemostatic Forceps



Mixer-Baby
AS-5-613-01
 Dissecting and Ligature Forceps
 13.5 cm, 13 cm,

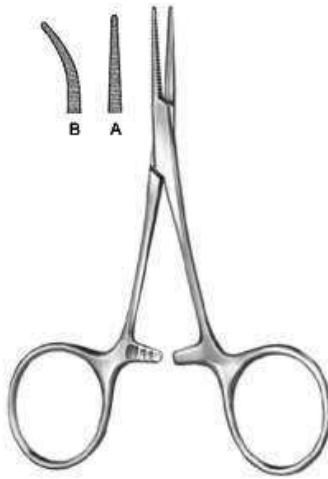

Hartmann
AS-5-614-10
 Haemostatic Forceps
 10 cm, 9.5 cm,



AS-5-615-12
 Ligature Forceps

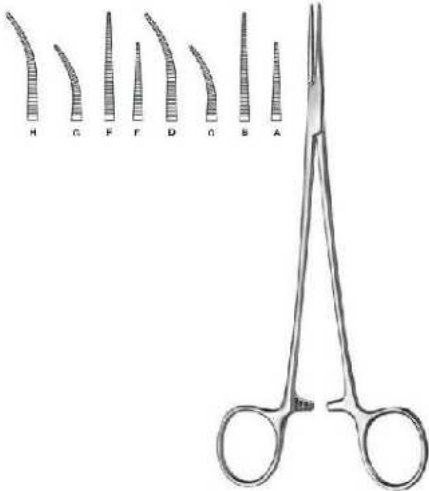

Halsted-Mosquito
AS-5-616-18
 Haemostatic Forceps
 12.5 cm, 14.5 cm, 14 cm,

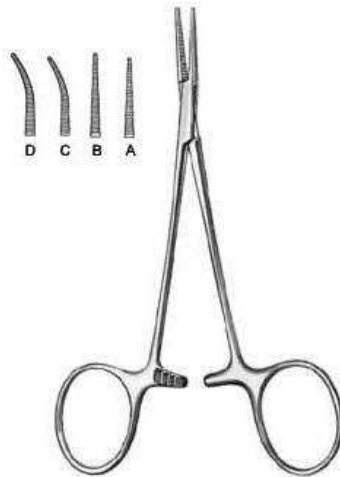

Mikro-Mosquito
AS-5-617-10
 Haemostatic Forceps
 10 cm, 12 cm, 9.5 cm, 11.5 cm,



Providence-Hospital
AS-5-618-14
 Haemostatic Forceps
 14 cm,

Haemostatic Forceps



Leriche
AS-5-619-15
 Haemostatic Forceps
 15.5 cm, 15 cm,

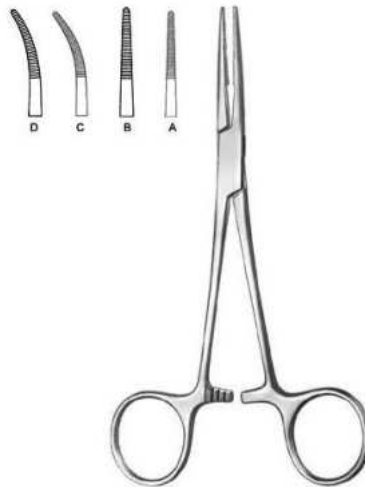

Kelly
AS-5-620-14
 Haemostatic Forceps
 14.5 cm, 14 cm,



Kelly-Rankin
AS-5-621-16
 Haemostatic Forceps
 16 cm, 15.5 cm,



Overholt-Baby
AS-5-622-14
 Dissecting and Ligature Forceps
 14.5 cm, 14 cm,



Crile
AS-5-623-14
 Haemostatic Forceps
 14.5 cm, 14 cm,



Crile-Rankin
AS-5-624-16
 Haemostatic Forceps
 16.5 cm, 16 cm,

Haemostatic Forceps

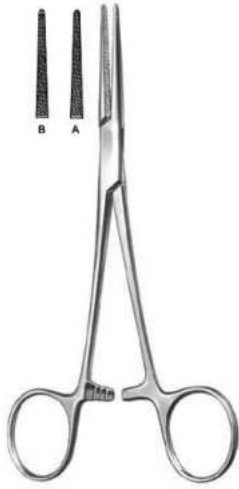

Lovelace
AS-5-625-15
Haemostatic Forceps
16 cm,



Dandy-Mosquito
AS-5-626-12
Haemostatic Forceps
12 cm,

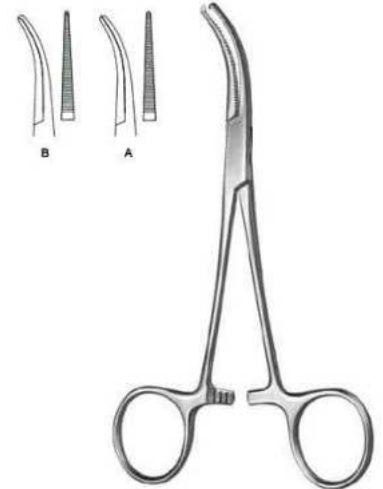

Dandy
AS-5-627-14
Haemostatic Forceps
14.5 cm, 14 cm,



Schmidt
AS-5-628-18
Dissecting and Ligature Forceps
18.5 cm, 19 cm,



Adson
AS-5-629-18
Dissecting and Ligature Forceps
19 cm, 18.5 cm,



Martin-Fuchsig
AS-5-630-20
Dissecting and Ligature Forceps
20.5 cm,

Haemostatic Forceps

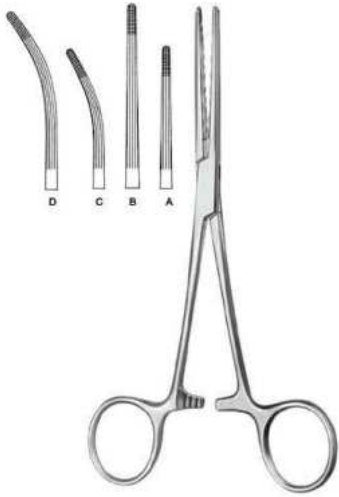

Rochester-Carmalt

AS-5-631-16

Haemostatic Forceps

17 cm, 20.5 cm, 16.5 cm, 20 cm,

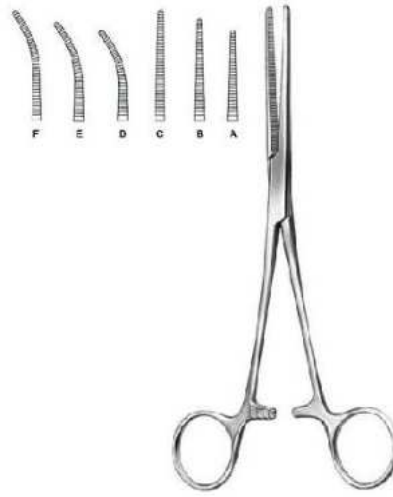

Pean

AS-5-632-13

Haemostatic Forceps

13.5 cm, 14.5 cm, 17 cm, 13 cm, 14 cm, 16.5 cm,

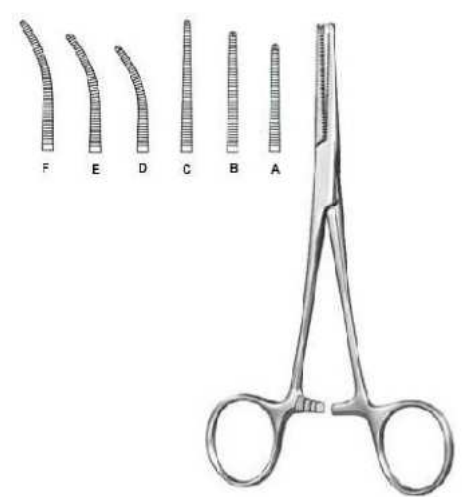

Kocher-Nippon

AS-5-633-14

Haemostatic Forceps

14.5 cm, 16.5 cm, 18.5 cm, 16 cm, 18 cm,

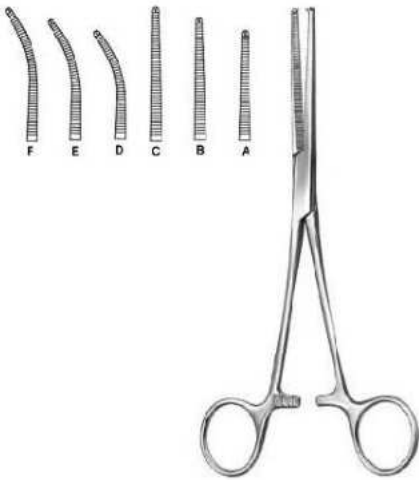

Kocher

AS-5-635-13

Haemostatic Forceps

13 cm, 14 cm, 16 cm,

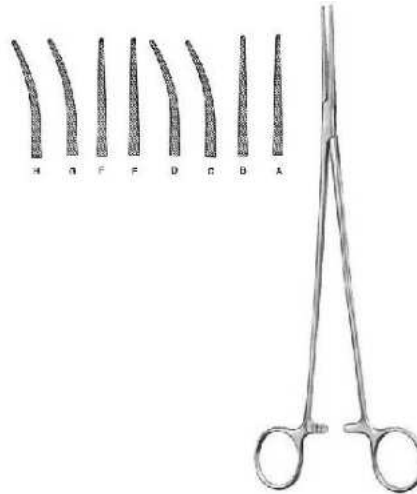

Bengolea

AS-5-636-20

Haemostatic Forceps

21.5 cm, 26 cm, 21 cm, 21.5 cm,

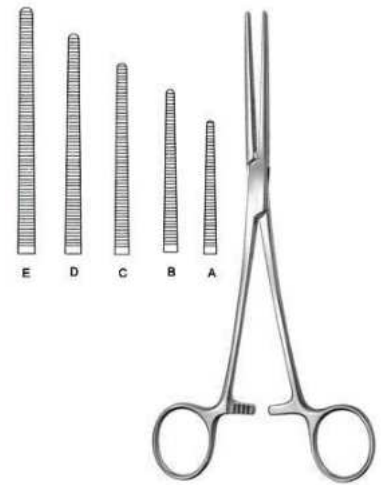

Pean (Rochester)

AS-5-637-14

Haemostatic Forceps

14.5 cm, 16.5 cm, 18.5 cm, 20.5 cm, 22.5 cm, 24.5 cm, 26 cm, 30.5 cm, 14 cm, 16 cm,

Haemostatic Forceps

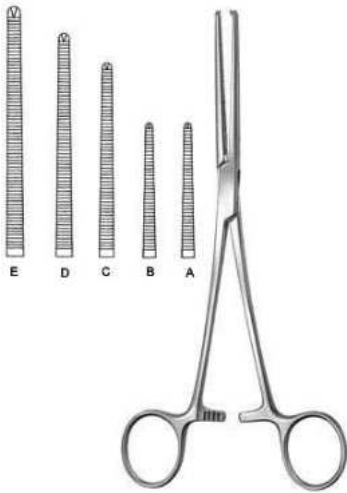

Kocher (Ochsner)

AS-5-638-14

Haemostatic Forceps

14.5 cm, 16.5 cm, 18.5 cm, 20.5 cm, 22.5 cm, 24.5 cm, 26 cm, 30.5 cm,

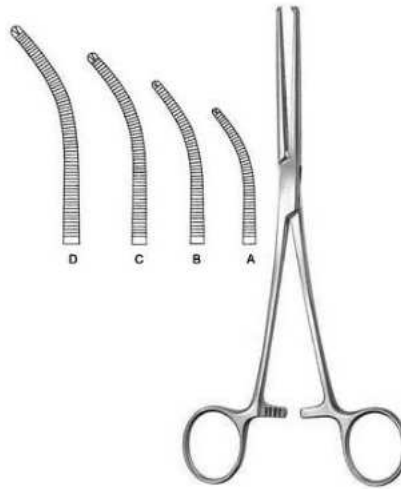

Kocher (Ochsner)

AS-5-639-14

Haemostatic Forceps

14 cm, 16 cm, 18 cm, 20 cm, 22 cm, 24 cm, 25.5 cm, 30 cm,

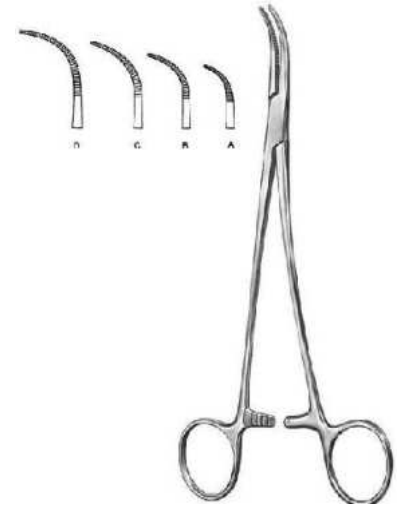

Overholt-Martin

AS-5-640-01

Dissecting and Ligature Forceps

18.5 cm Fig. 1, 20.5 cm Fig. 2, 21 cm Fig. 3, 21.5 cm Fig. 4, 24.5 cm Fig. 5,



Mixer-Baby

AS-5-641-18

Dissecting and Ligature Forceps

18.5 cm,



Adson-Baby

AS-5-642-14

Dissecting and Ligature Forceps

14.5 cm, 18 cm,



Heiss

AS-5-643-20

Dissecting and Ligature Forceps

21 cm, 20.5 cm, 20 cm,

Haemostatic Forceps



Overholt-Mixer
AS-5-644-21

Dissecting and Ligature Forceps
21.5 cm,

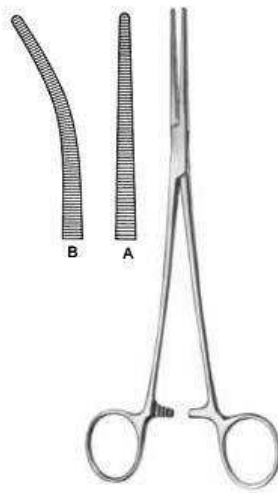

Roberts

AS-5-645-22

Dissecting and Ligature Forceps
22.5 cm, 21.5 cm,

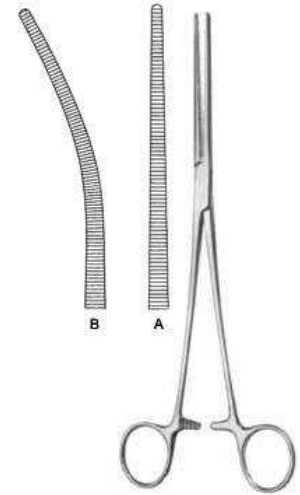

Sarot

AS-5-646-24

Dissecting and Ligature Forceps
25 cm, 24.5 cm,

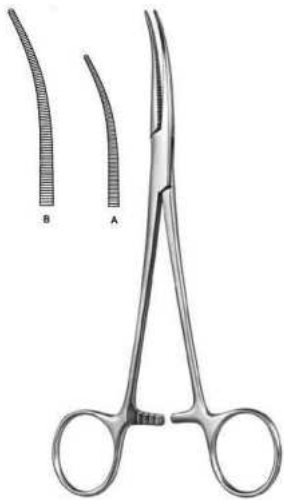

Crafoord

AS-5-647-18

Dissecting and Ligature Forceps
18 cm, 24.5 cm,

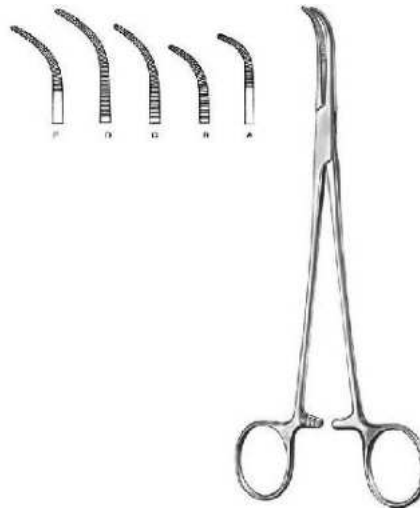

Overholt-Geissendorfer

AS-5-648-01

Dissecting and Ligature Forceps
20.5 cm Fig. 1, 20 cm Fig. 2, 21.5 cm Fig. 3, 22 cm Fig. 4, 21.5 cm Fig. 5, 22 cm Fig. 6, 27 cm Fig. 1, 26.5 cm Fig. 2, 27.5 cm Fig. 3, 28 cm Fig. 4,

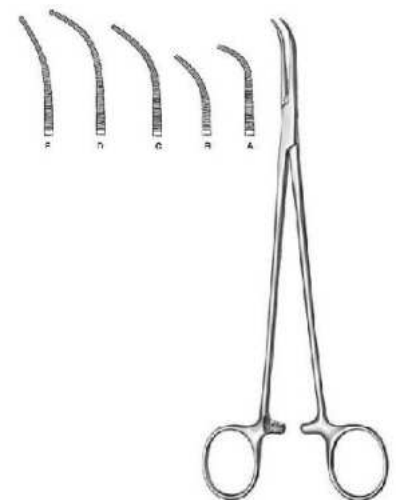

Overholt-Fino

AS-5-649-00

Dissecting and Ligature Forceps
21.5 cm, 21 cm, 22 cm, 23 cm, 22.5 cm,

Haemostatic Forceps

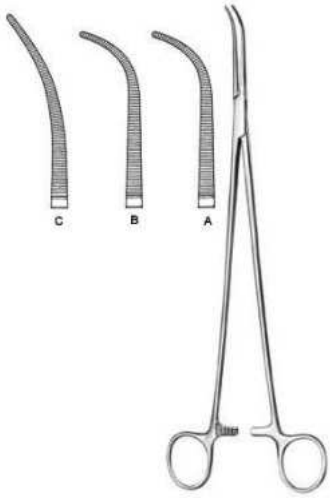

Overholt
AS-5-650-00

Dissecting and Ligature Forceps
29.5 cm, 30 cm,



Overholt-Mini
AS-5-651-01

Dissecting and Ligature Forceps
15 cm, 20 cm,

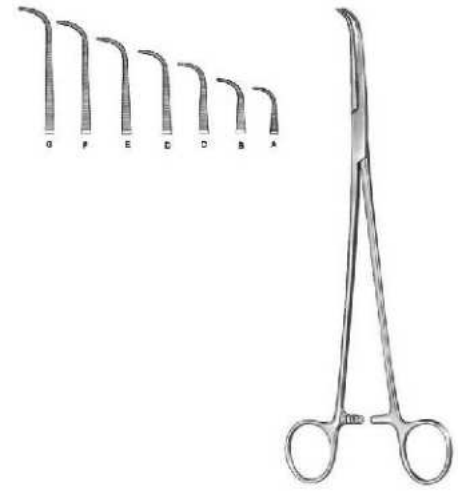

Gemini
AS-5-652-13

Dissecting and Ligature Forceps
13 cm, 16 cm, 18 cm, 21 cm, 23 cm, 25 cm, 28 cm,

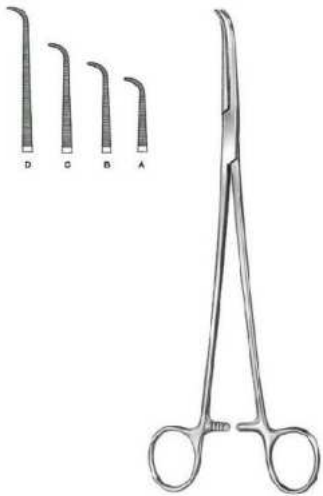

Mini-Gemini
AS-5-653-18

Dissecting and Ligature Forceps
18 cm, 22.5 cm, 25 cm, 28.5 cm,

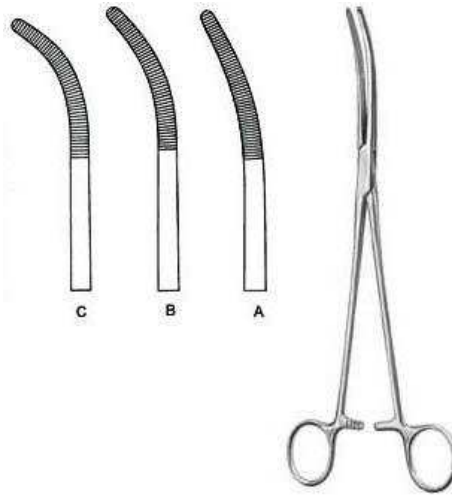

Rumel
AS-5-654-01

Dissecting and Ligature Forceps
24 cm Fig. 1, 23.5 cm Fig. 2, 23 cm Fig. 3, 24 cm Fig. 4, 23.5 cm Fig. 5,

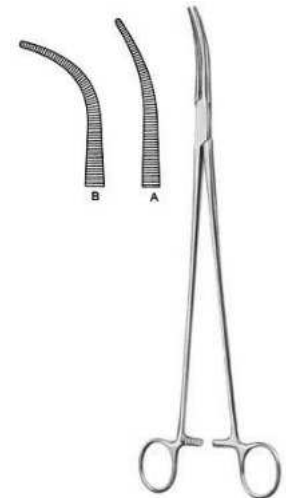

Zenker
AS-5-655-01

Dissecting and Ligature Forceps
29.5 cm, 28.5 cm,

Haemostatic Forceps



Mixer-Baby
AS-5-656-14

Dissecting and Ligature Forceps
13.5 cm,



Mixer
AS-5-657-15

Dissecting and Ligature Forceps
16 cm, 18 cm,



Mixer-O Shaugnessy
AS-5-658-19

Dissecting and Ligature Forceps
18 cm,



Mixer
AS-5-659-22

Dissecting and Ligature Forceps
22.5 cm,



Mixer
AS-5-660-23

Dissecting and Ligature Forceps
23 cm,



Wickstrom
AS-5-661-21

Dissecting and Ligature Forceps
21 cm, 24.5 cm,

Haemostatic Forceps

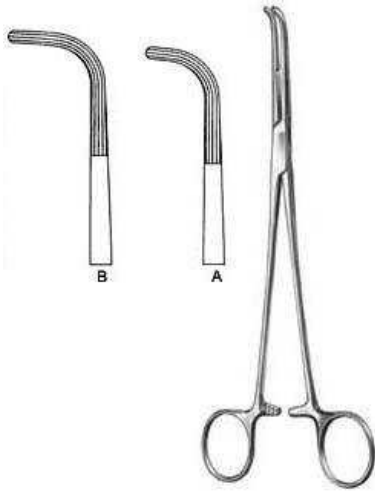

Mixer
AS-5-662-22

Dissecting and Ligature Forceps
22.5 cm, 26 cm, 28 cm,



Mc Quigg-Mixer
AS-5-663-22

Dissecting and Ligature Forceps
23.5 cm,



Lower
AS-5-664-18

Dissecting and Ligature Forceps
18.5 cm,



Lahey
AS-5-665-19

Bile
Duct Clamp 19.5
cm, 22.5 cm,



Finochietto
AS-5-666-24

Dissecting and Ligature Forceps
24 cm,



Uro-Tangential
AS-5-667-01

Tangential Forceps
25 cm, 27 cm,

Haemostatic Forceps

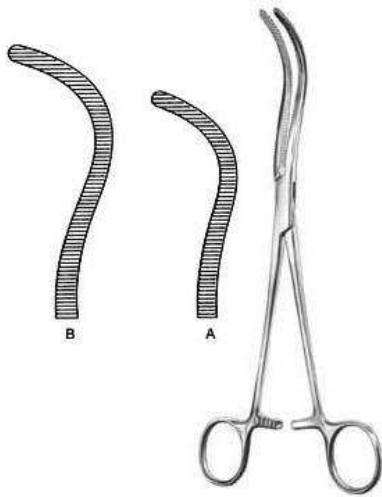

Guyon
AS-5-668-20
 Kidney Pedicle Clamp
 23 cm, 24 cm,



Guyon
AS-5-669-23
 Kidney Pedicle Clamp
 19.5 cm, 21.5 cm, 24 cm,



Desjardins
AS-5-670-21
 Bile Duct Clamp
 21 cm,

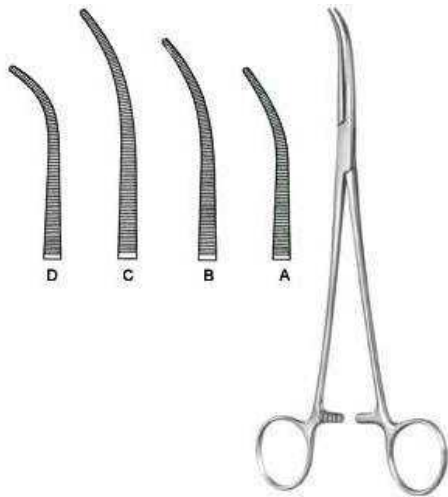

Kelly
AS-5-671-19
 Dissecting and Ligature Forceps
 19.5 cm Fig. 1, 22.5 cm Fig. 1, 24.5 cm Fig.
 1, 19 cm Fig. 2, 22 cm Fig. 2, 24 cm Fig. 2, 18.5
 cm Fig. 3, 21.5 cm Fig. 3, 23.5 cm Fig. 3,



Lawrence
AS-5-672-28
 Dissecting and Ligature Forceps
 28 cm,



Meeker
AS-5-673-28
 Dissecting and Ligature Forceps
 28 cm,



Negus
AS-5-674-19
Haemostatic Forceps
19.5 cm Fig. 1, 20 cm Fig. 2,

Towel & Tubing Clamps



Schaedel
AS-5-701-09 Towel
Clamp sharp 9 cm,



Jones
AS-5-702-05 Towel
Clamp sharp 5.5
cm, 8.5 cm,



Jones-Martin
AS-5-703-09 Towel
Clamp sharp 8.5
cm,



Backhaus
AS-5-704-11
Towel Clamp
11.5 cm, 13 cm,



Backhaus
AS-5-705-11
Towel Clamp
11.5 cm,



Backhaus
AS-5-706-08
Towel Clamp
9 cm, 11.5 cm, 13 cm, 16 cm,

Towel & Tubing Clamps

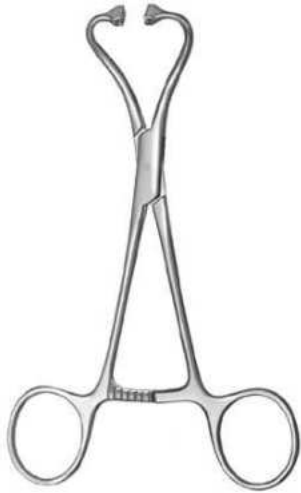

Peers-Bertram modif.
AS-5-707-15

Towel Clamp wide jaw for tube fixation
15.5 cm,



Roder
AS-5-708-13

Towel Clamp
13.5 cm,

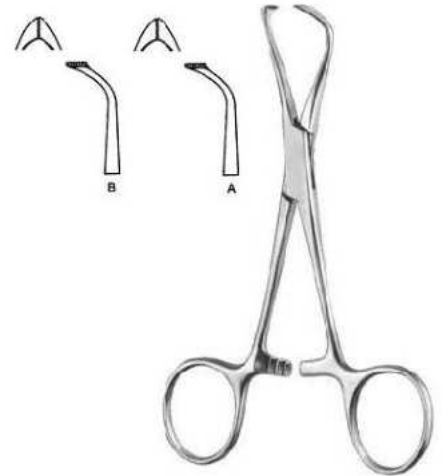

Lorna
AS-5-709-10

Towel Clamp fine serrated, wide jaw
9.5 cm, 13 cm,



Bernhard
AS-5-710-16

Towel Clamp
16.5 cm,

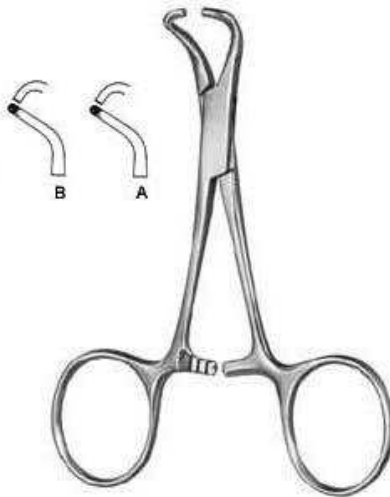

Tohoku
AS-5-711-10

Towel Clamp
10.5 cm blunt, 13.5 cm blunt, 14.5 cm,

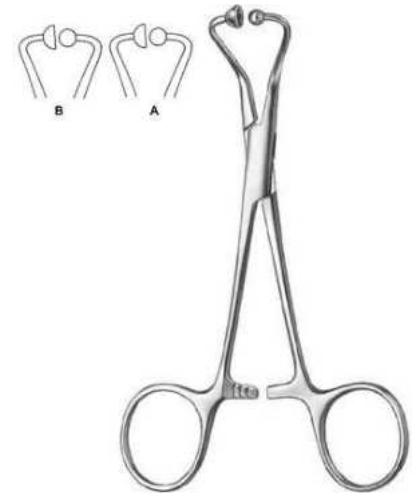

AS-5-712-11

Towel Clamp for paper clothes
11.5 cm, 14 cm,

Towel & Tubing Clamps



Lane
AS-5-713-20
Towel Clamp
19.5 cm,



AS-5-714-06
Tube Holder for fixation of six tubes



AS-5-715-14
Tubing Clamp extra long ratchet
14 cm,



AS-5-716-16
Tubing Clamp
16.5 cm,

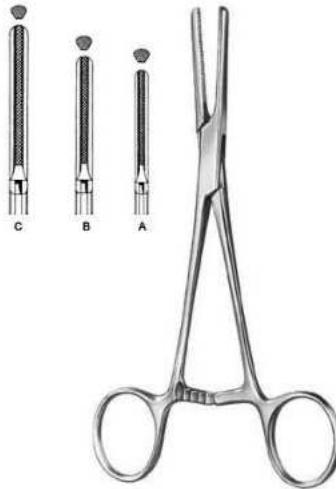

AS-5-717-15
Tubing Clamp
15.5 cm, 19 cm, 20.5 cm,

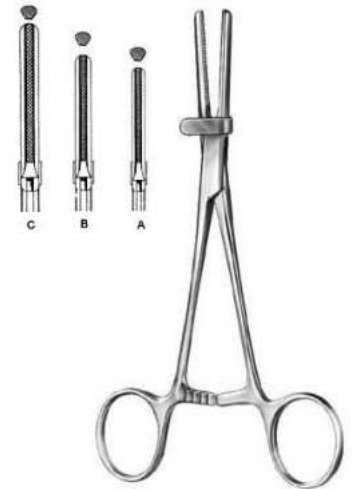

AS-5-718-15
Tubing Clamp with safety guard
15.5 cm, 19 cm, 20.5 cm,

Dressing & Sponge Forceps

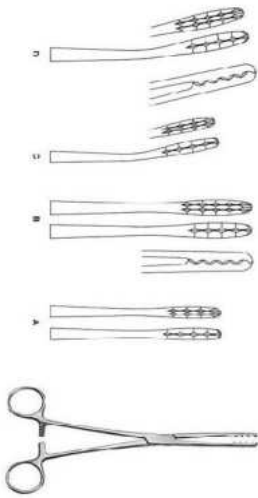

Ulrich
AS-5-801-22
 Dressing Forceps
 22.5 cm, 26.5 cm,



Lister
AS-5-802-13
 Sinus Forceps
 13 cm, 16 cm, 18 cm,



Martin
AS-5-803-17
 Dressing Forceps
 17.5 cm, 17 cm,

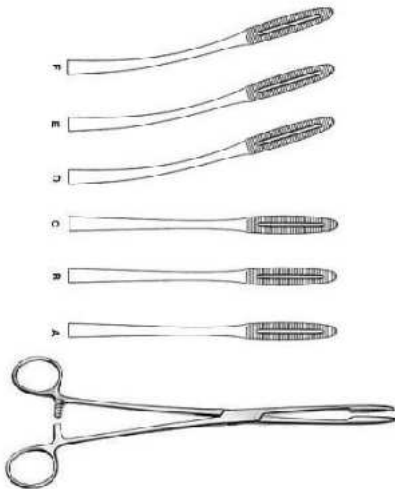

Gross-Maier
AS-5-804-20
 Dressing Forceps
 20.5 cm, 22 cm, 26.5 cm, 20 cm, 21.5 cm, 26 cm,



AS-5-805-40
 Tunneling Forceps
 39.5 cm,



Collin
AS-5-806-25
 Dressing Forceps
 25.5 cm,

Dressing & Sponge Forceps



Cheron
AS-5-807-25
 Dressing Forceps
 23.5 cm,



Bozemann
AS-5-808-26
 Sponge Forceps
 26 cm,



Foerster
AS-5-809-25
 Sponge Forceps
 25 cm, 18 cm, 20.5 cm, 24.5 cm, 17.5 cm, 20 cm, 24.5 cm,

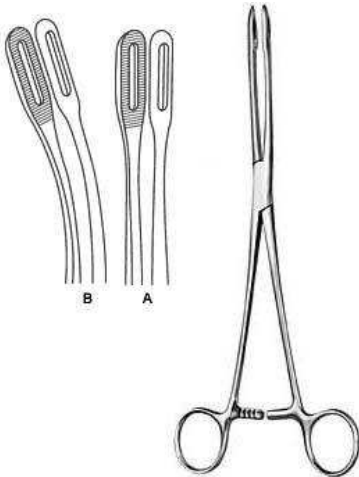

Foerster
AS-5-810-25
 Sponge Forceps
 25 cm, 24.5 cm,

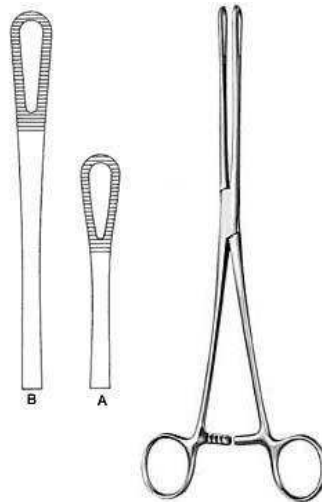

Rampley
AS-5-811-18
 Sponge Forceps
 18.5 cm, 24.5 cm,



Vickers
AS-5-901-18
 Skin Hooklet
 18.5 cm,



Vickers
AS-5-902-01
 Bone Hooklet
 17 cm,



Vickers
AS-5-903-01
 Tendon Hooklet
 17 cm,



Vickers
AS-5-904-02
 Hooklet
 16 cm,

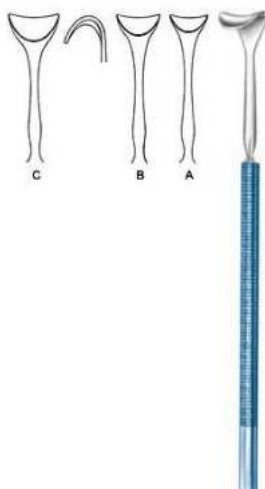

Vickers
AS-5-905-12
 Saddle Hook
 14 cm,



Graefe
AS-5-906-01
 Micro Hooklet
 15 cm,

Retractors

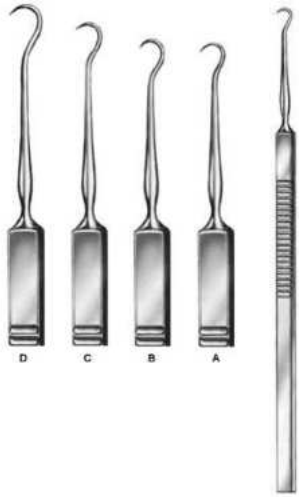

AS-5-907-01

Skin Hook

16 cm Fig. 1, 16 cm Fig. 2, 16 cm Fig. 3, 16 cm Fig. 4,



O Connor

AS-5-908-16

Skin Hook

16 cm,

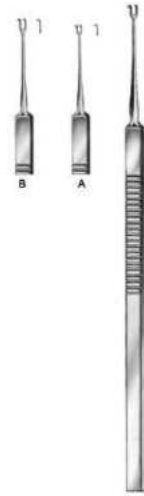

Guthrie

AS-5-909-01

Skin Hook

15.5 cm,



AS-5-910-01

Hooklet

16.5 cm,



AS-5-911-01

Hooklet

16.5 cm,



AS-5-912-02

Hooklet

16 cm,

Retractors



AS-5-913-04
Hooklet
16.5 cm,



AS-5-914-12
Vessel Hook
12 cm,



Desmarres
AS-5-915-08
Saddle Hook
16 cm 8 mm, 16 cm 10 mm, 16 cm 12 mm, 16 cm 14 mm, 16 cm 16 mm, 16 cm 18 mm,

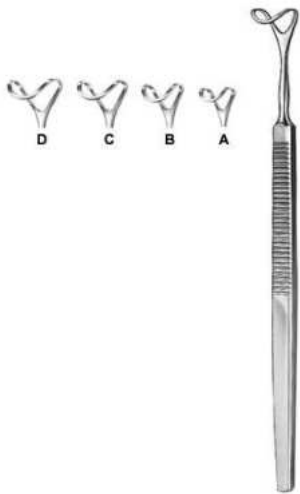

AS-5-916-12
Saddle Hook
16 cm 12 mm, 16 cm 14 mm, 16 cm 16 mm, 16 cm 18 mm,

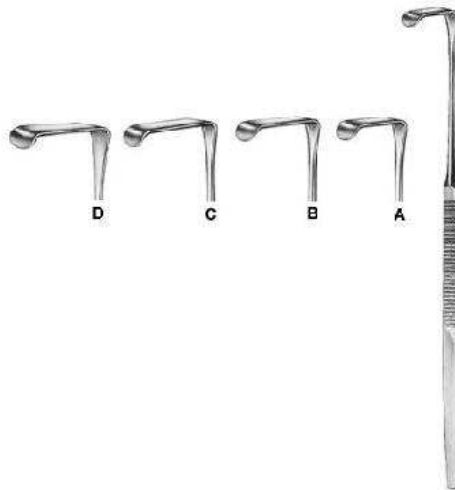

Langenbeck-Mini
AS-5-917-10
Hooklet
16 cm,



AS-5-918-16
Hooklet
16 cm 14 x 8,



AS-5-919-01
Hooklet
16.5 cm,



AS-5-920-01
Hooklet
16.5 cm,



Meyerding
AS-5-921-01
Hooklet
17.5 cm Fig. 1, 17.5 cm Fig. 2, 17.5 cm Fig. 3, 17.5 cm Fig. 4, 17.5 cm Fig. 5, 17.5 cm Fig. 6,



Senn-Green
AS-5-922-01
Hooklet
15 cm Fig. 1, 15 cm Fig. 2,



Ragnell-Davis
AS-5-923-14
Hooklet
14 cm,

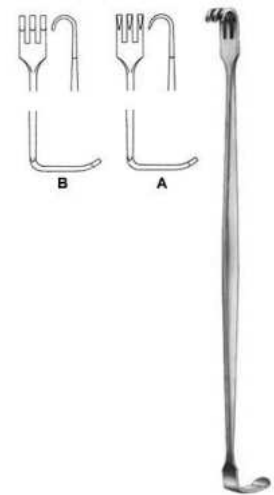

Senn-Miller
AS-5-924-16
Hooklet
16 cm,

Retractors



Cushing
AS-5-925-20
 Retractor
 20.5 cm,

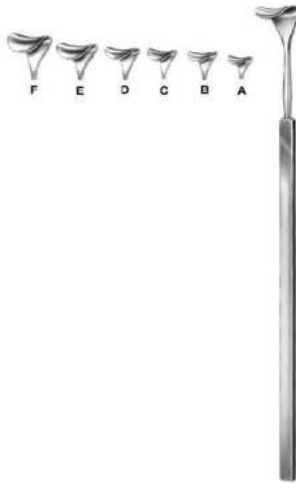

Cushing
AS-5-926-08
 Saddle Hook
 20.5 cm 8 mm wide, 20.5 cm 10 mm wide, 20.5 cm 12 mm wide, 20.5 cm 14 mm wide, 20.5 cm 16 mm wide, 20.5 cm 18 mm wide,

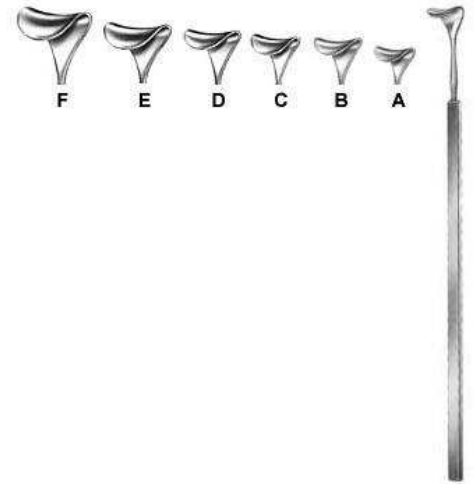

Cushing
AS-5-927-08
 Saddle Hook 8 mm to 18 mm wide
 24 cm,



Brom
AS-5-928-01
 Vein Hook
 19.5 cm,



Strandell-Stille
AS-5-929-01
 Hooklet
 19 cm Fig. 1, 19 cm Fig. 2,



Klapp
AS-5-930-01
 Retractor 12 x 6, 12 x 11, 15 x 11
 17.5 cm,

Retractors



AS-5-931-04
Hooklet
16.5 cm,

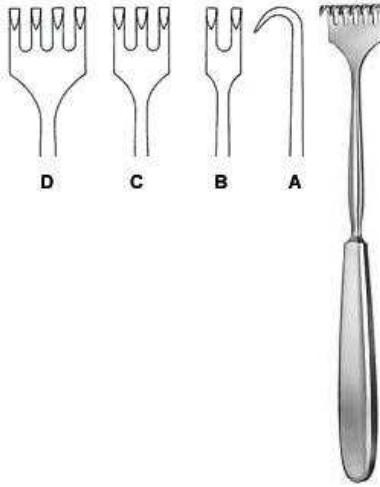

Volkmann
AS-5-932-01
Retractor
21.5 cm,



Volkmann
AS-5-933-01
Retractor
22 cm, 21.5 cm,



Kocher
AS-5-934-01
Retractor
22 cm,

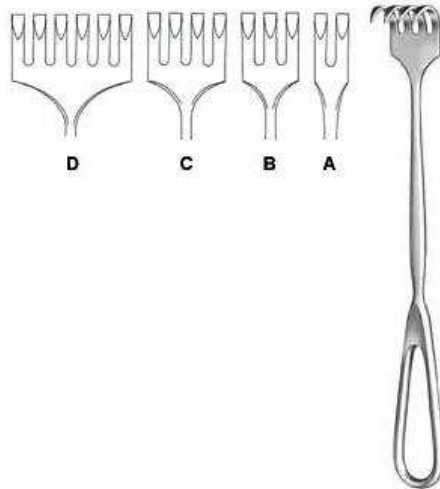

Martin
AS-5-935-02
Retractor
22.5 cm,

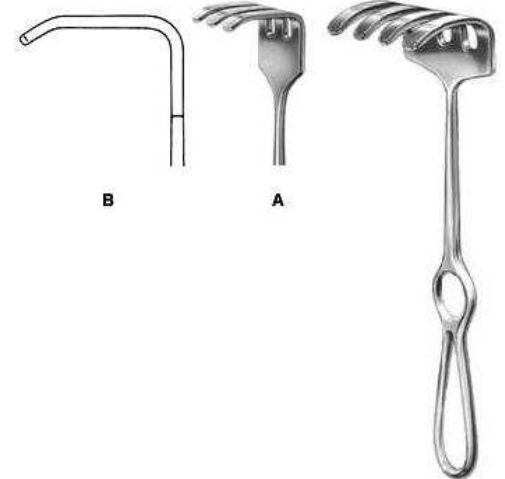

Ollier
AS-5-936-03
Retractor
23 cm 36 x 30, 23 cm 36 x 60,

Retractors

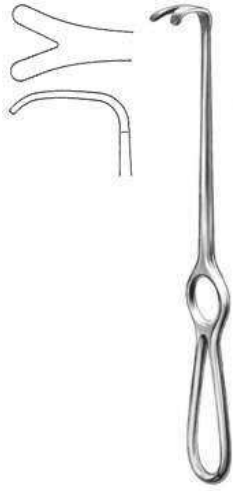

Wassmund
AS-5-937-02
Retractor
20.5 cm 33 x 21,

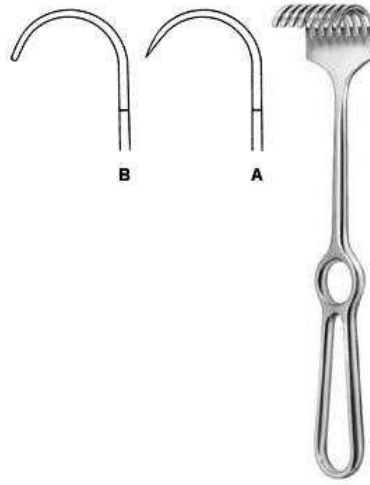

Korte
AS-5-938-08
Retractor
24.5 cm 40 x 30,

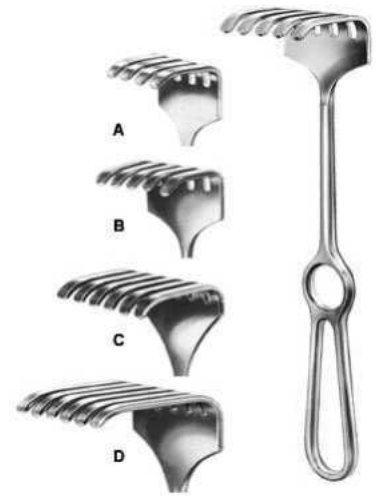

Israel
AS-5-939-04
Retractor
25.5 cm,

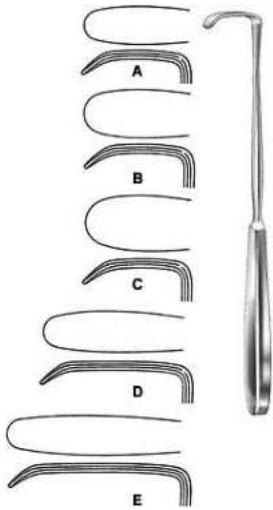

Langenbeck
AS-5-940-01
Retractor
22.5 cm 30 x 11 mm, 22.5 cm 30 x 14 mm, 22.5 cm 30 x 16 mm, 22.5 cm 40 x 11 mm, 22.5 cm 50 x 11 mm,

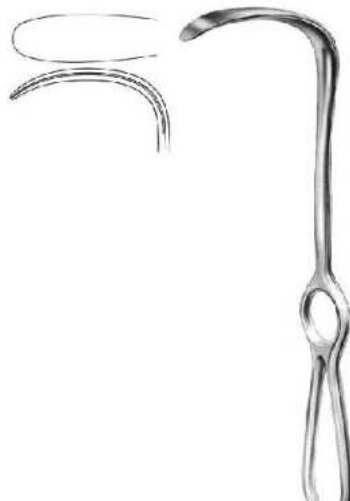

Langenbeck
AS-5-942-21
Retractor
21 cm 65 x 20 mm,



Langenbeck
AS-5-943-21
Retractor
22.5 cm 85 x 15 mm,

Retractors



Lahey
AS-5-944-19
 Retractor
 19.5 cm 36 x 19 mm,



Little
AS-5-945-20
 Retractor
 20 cm 13 x 15 mm,

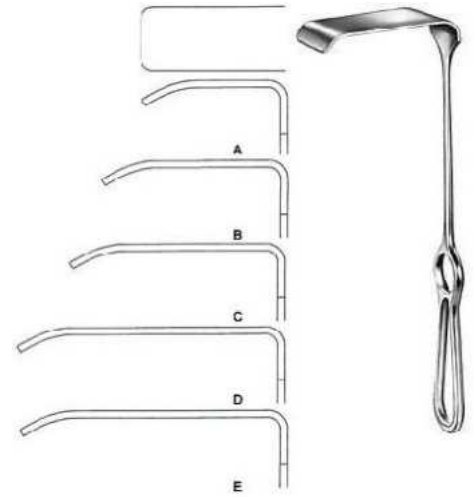

Kocher
AS-5-946-18
 Retractor
 23 cm 43 x 18 mm, 23 cm 53 x 20 mm, 23 cm 63 x 25 mm, 23 cm 77 x 30 mm, 23 cm 78 x 40 mm,

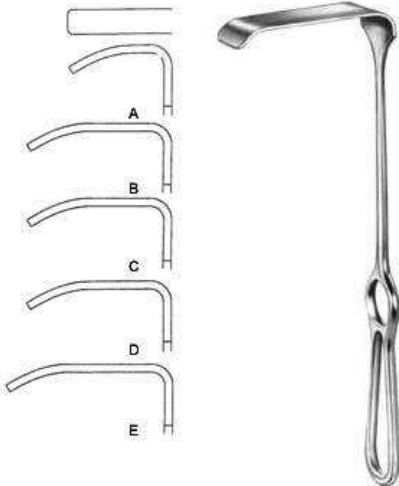

Kocher-Langenbeck
AS-5-947-01
 Retractor
 21.5 cm 25 x 6 mm, 21.5 cm 35 x 8 mm, 21.5 cm 35 x 11 mm, 21.5 cm 35 x 15 mm, 21.5 cm 40 x 11 mm, 21.5 cm 55 x 11 mm, 21.5 cm 70 x 14 mm, 21.5 cm 80 x 12 mm,

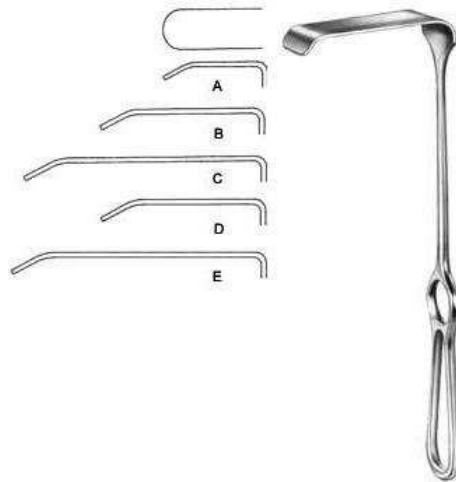

Kocher-Langenbeck
AS-5-948-01
 Retractor
 21.5 cm 25 x 10 mm, 21.5 cm 40 x 13 mm, 21.5 cm 60 x 13 mm, 21.5 cm 40 x 18 mm, 21.5 cm 60 x 18 mm, 21.5 cm 85 x 18 mm, 21.5 cm 60 x 25 mm, 21.5 cm 85 x 25 mm,

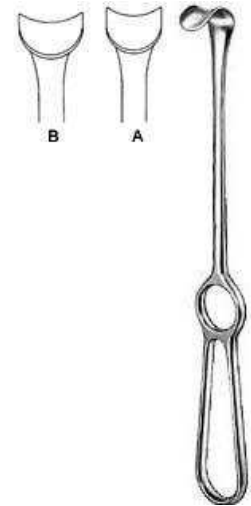

Kocher
AS-5-949-01
 Retractor
 21.5 cm 22 x 12 mm, 21.5 cm 24 x 14 mm,

Retractors

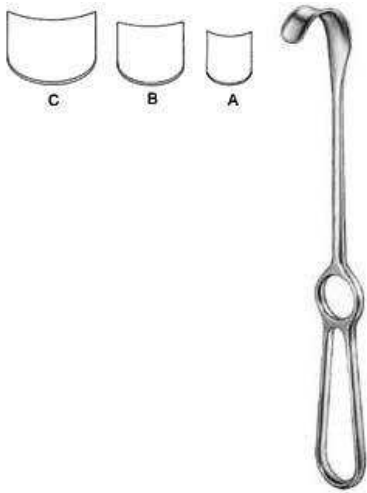

Kocher
AS-5-950-01

Retractor

22 cm 42 x 10 mm, 22 cm 42 x 15 mm, 22 cm 43 x 20 mm,

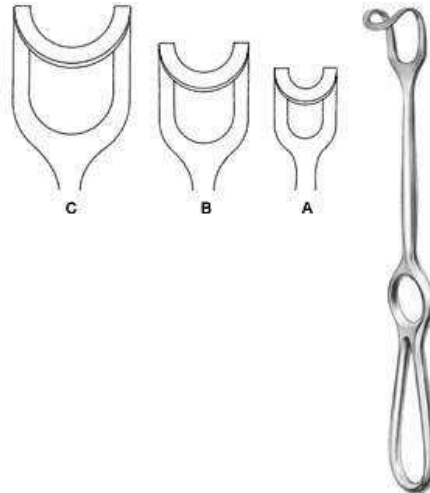

Middeldorpf

AS-5-951-01

Retractor

21.5 cm 18 x 17 mm, 23 cm 25 x 22 mm, 24.5 cm 30 x 31 mm,

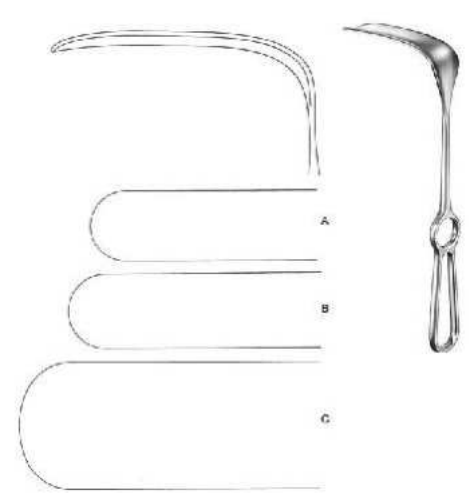

Doyen-Stillé

AS-5-952-01

Retractor

26 cm 97 x 29 mm, 26 cm 101 x 31 mm, 26 cm 127 x 52 mm,



Hosel

AS-5-953-01

Retractor

26 cm 63 x 21 mm, 26 cm 83 x 30 mm, 26 cm 103 x 30 mm, 26 cm 120 x 30 mm, 26 cm 140 x 30 mm, 26 cm 140 x 40 mm,

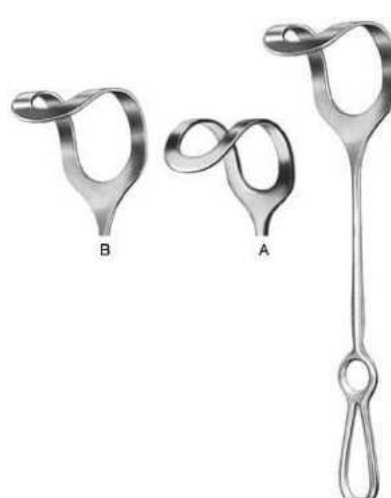

Middeldorpf

AS-5-954-01

Retractor

27 cm 48 x 45 mm, 27 cm 52 x 50 mm, 27 cm 60 x 70 mm,

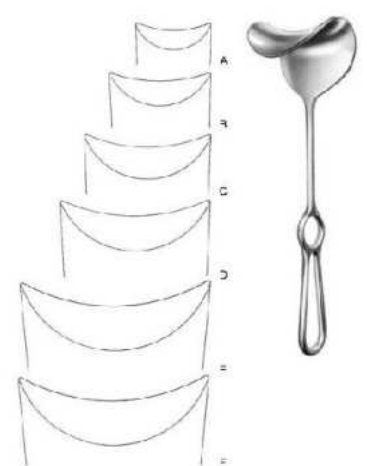

Fritsch

AS-5-955-00

Retractor

23.5 cm 37 x 31 mm, 24 cm 38 x 40 mm, 25 cm 43 x 51 mm, 25 cm 49 x 61 mm, 25.5 cm 48 x 75 mm, 25.5 cm 65 x 85 mm,

Retractors



Doyen
AS-5-956-25
Retractor
24 cm 48 x 88 mm,



Kocher
AS-5-957-22
Retractor
24 cm 73 x 25 mm,



Kocher
AS-5-958-01
Retractor
25 cm 80 x 45 mm, 25 cm 80 x 55 mm, 25 cm
80 x 65 mm,



Martin
AS-5-959-25
Retractor
26 cm 110 x 27 mm,

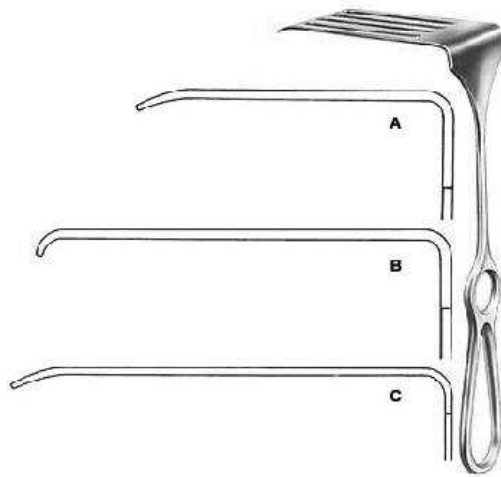

Coryllos
AS-5-960-01
Retractor
24 cm 85 x 22 mm, 24 cm 108 x 43 mm, 24 cm
119 x 65 mm,



Davidson
AS-5-961-01
Retractor
19 cm 80 x 54 mm, 18.5 cm 80 x 95 mm,

Retractors

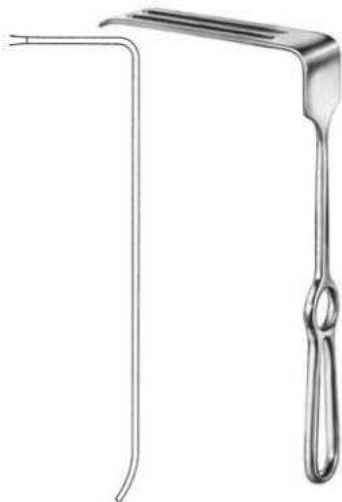

Sauerbruch

AS-5-962-25

Retractor

25.5 cm 127 x 38 mm,

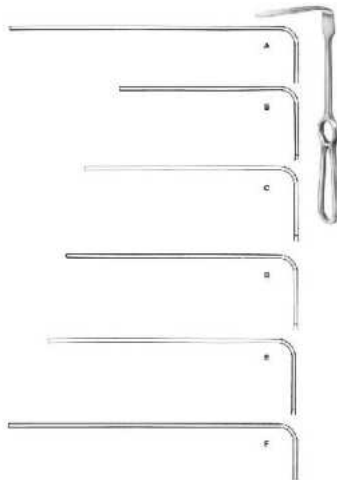

Brunner

AS-5-963-08

Retractor

25.5 cm 84 x 20 mm, 25.5 cm 104 x 25 mm, 25.5 cm 124 x 30 mm, 25.5 cm 130 x 30 mm, 25.5 cm 144 x 30 mm, 25.5 cm 160 x 30 mm, 25.5 cm 164 x 30 mm,

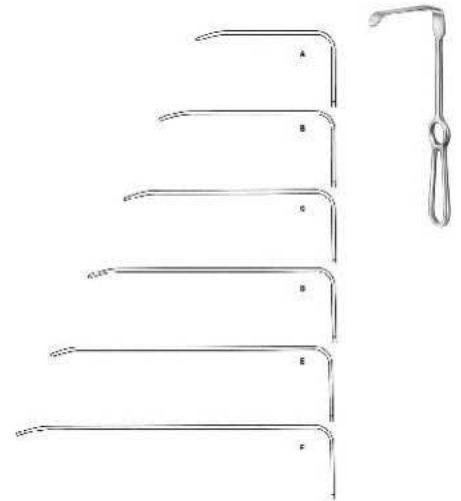

Brunner

AS-5-964-08

Retractor

25.5 cm 82 x 20 mm, 25.5 cm 102 x 20 mm, 25.5 cm 122 x 25 mm, 25.5 cm 140 x 25 mm, 25.5 cm 162 x 30 mm, 25.5 cm 182 x 30 mm,

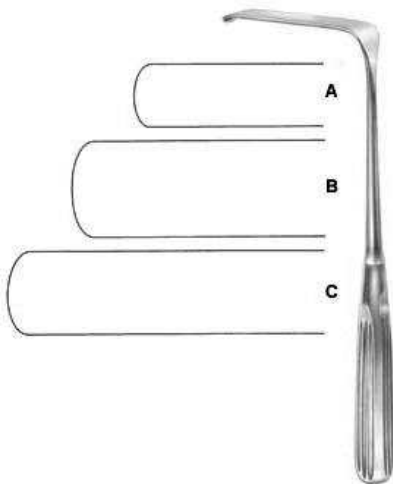

Sauerbruch

AS-5-965-01

Retractor

22.5 cm 50 x 15mm, 22.5 cm 63 x 23mm, 22.5 cm 80 x 20mm,



Deaver

AS-5-966-01

Retractor

18 cm 19mm,

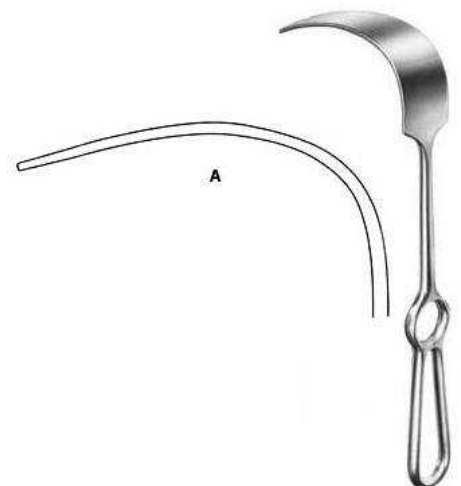

Mikulicz

AS-5-968-01

Retractor

25 cm 90 x 35mm, 25 cm 125 x 50mm, 25 cm 160 x 50mm,

Retractors



Mikulicz
AS-5-969-26
Retractor
26 cm 90 x 55mm,

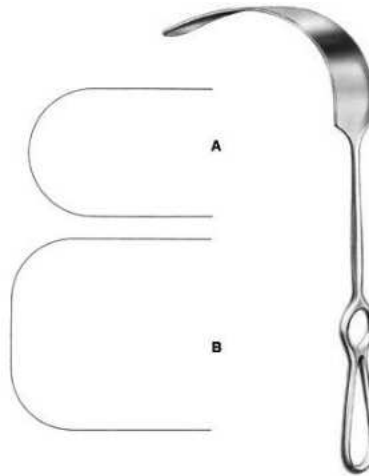

Kelly
AS-5-970-01
Retractor
27.5 cm 205 x 38mm, 27.5 cm 205 x 57mm,



Farabeuf
AS-5-971-00
Retractor
15 cm Fig. 1 = 23 x 16, 15 cm Fig. 1 = 26 x 16, 15 cm Fig. 2 = 27 x 16, 15 cm Fig. 2 = 30 x 16,

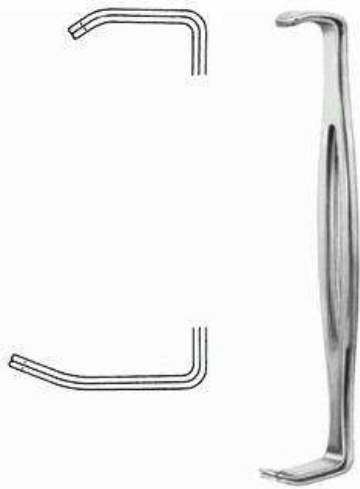

Parker-Langenbeck
AS-5-972-00
Retractor
21.5 cm Fig. 1 = 21x15mm, 21.5 cm Fig. 1 = 40x15mm, 21.5 cm Fig. 2 = 25x15mm, 21.5 cm Fig. 2 = 45x15mm,



Alm
AS-5-973-07
Wound Spreaders, self-retaining
7 cm,



Alm
AS-5-974-07
Wound Spreaders, self-retaining
7 cm,

Retractors



Gosset
AS-5-975-22
Abdominal Retractor
18.5 cm,



Balfour-Baby
AS-5-976-00
Abdominal Retractor spreading 90mm, 1
central blade 24 x 20mm
12.5 cm,

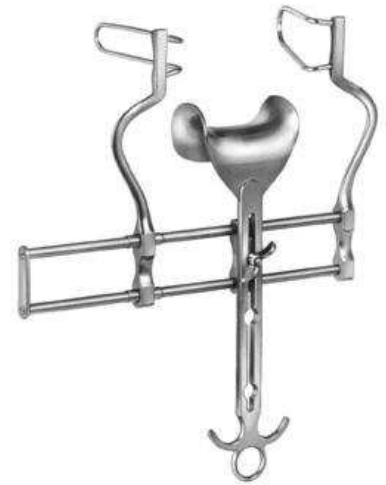

Balfour
AS-5-977-00
Abdominal Retractor spreading 180mm,
lateral blades 70 x 35mm, 1 central blade
20 cm,

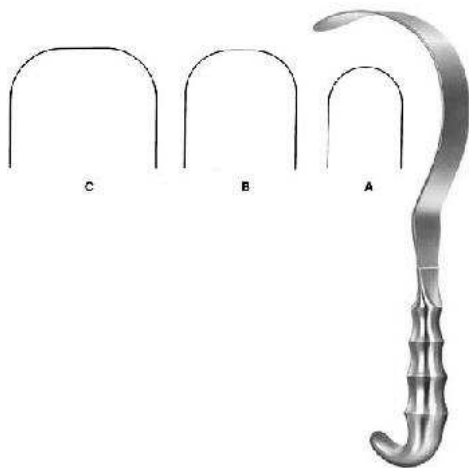

Deaver
AS-5-967-04
Retractor
31.5 cm 25mm, 31.5 cm 38mm, 31.5 cm
50mm, 31.5 cm 100mm,



AS-5-1001-11

Probe

11.5 cm, 13 cm, 14.5 cm, 16 cm, 18 cm, 20 cm, 25 cm, 30 cm,



AS-5-1002-11

Probe

11.5 cm, 13 cm, 14.5 cm, 16 cm, 18 cm, 20 cm, 25 cm, 30 cm,

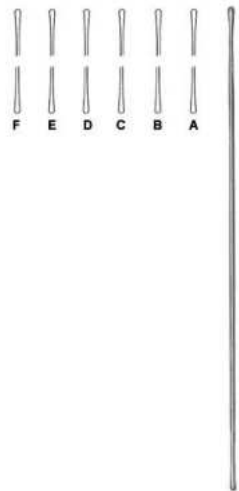

AS-5-1003-13

Probe

13 cm, 14.5 cm, 16 cm, 18 cm, 20 cm, 25 cm,



AS-5-1004-13

Probe with eye

13 cm, 14.5 cm, 16 cm,

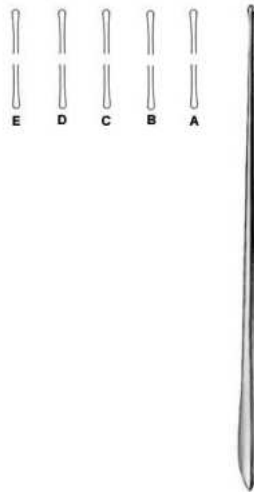

AS-5-1006-13

Myrtle Leaf Probe

13 cm, 14.5 cm, 16 cm, 18 cm, 20 cm,



AS-5-1007-13

Grooved Director

13 cm, 14 cm, 16 cm,



AS-5-1008-13
Grooved Director
13 cm, 14.5 cm, 16 cm,



Doyen
AS-5-1009-14
Grooved Director
14.5 cm,



Nelaton
AS-5-1010-16
Grooved Director
16 cm,

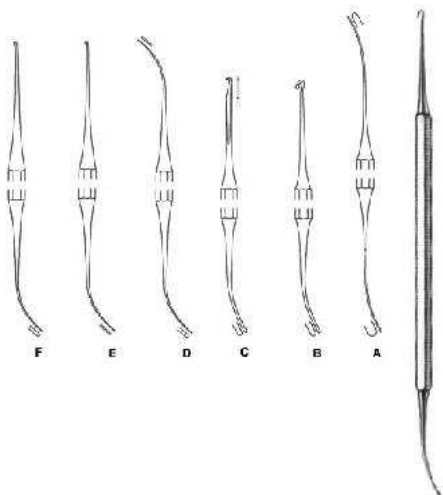

Varady
AS-5-1011-01
Phlebdissector
18 cm, 17.5 cm,

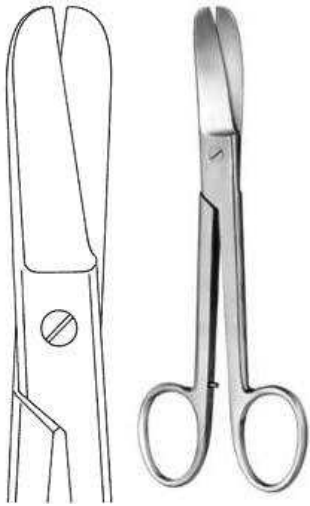

Lorenz
AS-6-101-23
Bandage Scissors heavy pattern
23 cm,



Lister
AS-6-102-14
Bandage Scissors
14.5 cm, 18.5 cm, 20 cm,

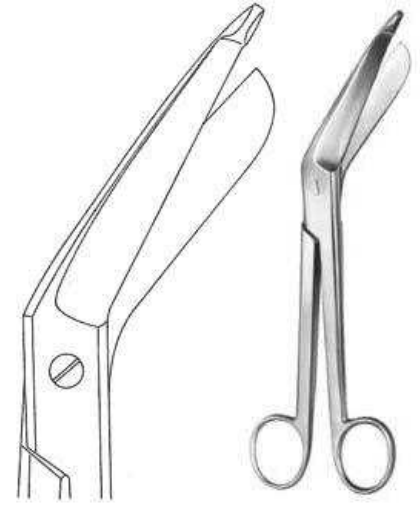

Bergmann
AS-6-103-23
Plaster Shears
23.5 cm,



Esmarch
AS-6-104-20
Plaster Shears heavy pattern, short blades
20 cm,



AS-6-105-15
Bandage Scissors black plastic ring with
autodavable
16 cm, 19 cm,



AS-6-106-18
Bandage Scissors black plastic rings
19 cm, 16 cm,

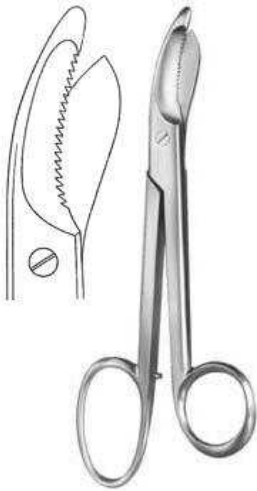

Brun's
AS-6-107-24
Plaster Scissors
24 cm,

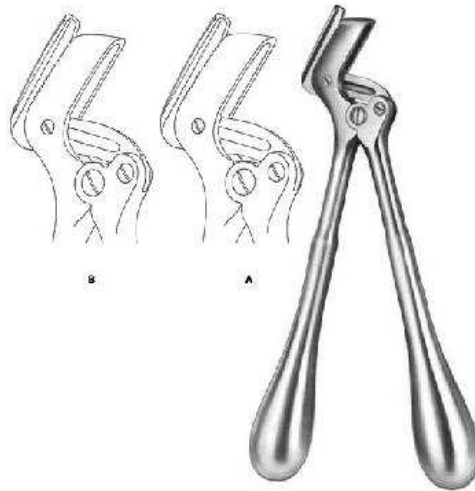

Stille-Martin
AS-6-108-23
Plaster Shears
23 cm, 27 cm, 38 cm,

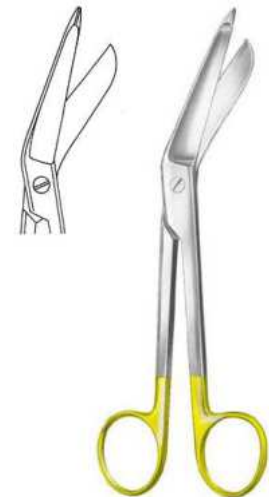

Lister
AS-6-109-18
Bandage Scissors
18 cm,



Brun's
AS-6-110-24
Plaster Scissors
24 cm,



Hopkins
AS-6-111-20
Plaster Knife with wooden handle
20 cm,



Reiner
AS-6-112-18
Plaster Knife
18 cm,



Reiner
AS-6-113-18
Plaster Knife
18 cm,



Martin
AS-6-114-21
Plaster Knife with wooden handle
21 cm,



Engel
AS-6-115-14
Plaster Saw
15.5 cm,

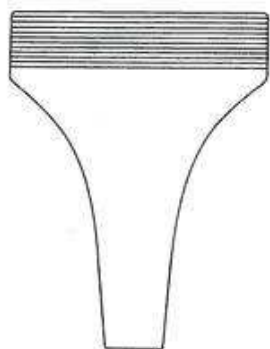

Hennig
AS-6-116-28
Plaster Spreader
28 cm,

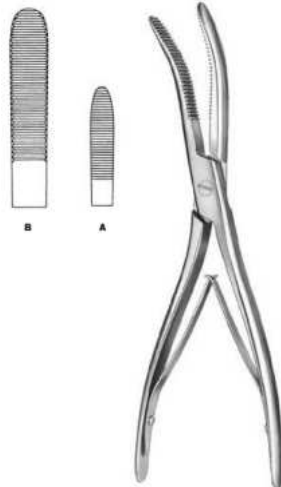

Wolff
AS-6-117-18
Plaster Breaker
18 cm, 26.5 cm,



Gigli
AS-8-101-01
Wire Saw Handle



De Martel
AS-8-102-33
Wire Saw Guide
33 cm,



Crutchfield
AS-8-103-01
Skull Traction Tong small pattern



AS-8-104-01
Skull Traction Tong large pattern
22.5 cm,



Dahlgren
AS-8-105-20
Cranial Rongeur
20 cm,



Olivecrona-Toennis
AS-8-106-14
Clip Applying Forceps



McKenzie
AS-8-107-19
Clip Applying Forceps
18.5 cm,



Olivecrona
AS-8-108-18
Dura Dissector
18 cm,



Olivecrona
AS-8-109-19
Dura Dissector
20 cm,



Milligan
AS-8-110-21
Dura Dissector
21.5 cm,



Davis
AS-8-111-21
Dura Dissector sharp
21.5 cm,



AS-8-112-22
Dura Dissector
22 cm,



Davis
AS-8-113-24
Dura Dissector
24.5 cm,



Love
AS-8-114-19
Nerve Root Retractor
21.5 cm, 18 cm, 11 cm,



Olivecrona
AS-8-115-18
Brain Spatula
18 cm,



Scoville
AS-8-116-23
Nerve Root Retractor 8mm
23.5 cm,



Holsher
AS-8-117-24
Nerve Root Retractor 8mm
23.5 cm,

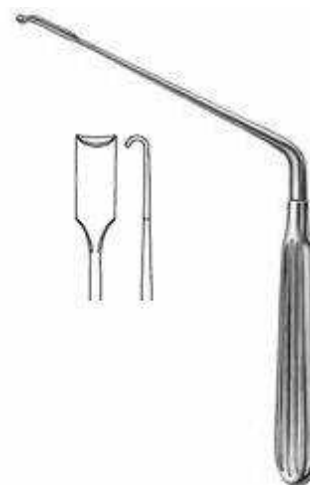

Scoville
AS-8-118-19
Nerve Root Retractor 7mm
16.5 cm,



Groningen
AS-8-119-26
Nerve Hook
26.5 cm,



Groningen
AS-8-120-26
Nerve Hook
26.5 cm,



Cushing
AS-8-121-19
Nerve Hook blunt
19 cm,28 cm,

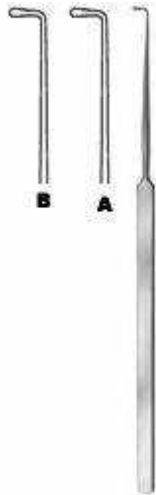

Cushing
AS-8-122-19
Nerve Hook
19.5 cm,28 cm,



Smithwick
AS-8-123-17
Nerve Hook
17 cm,21 cm,



Halle
AS-8-125-20
Dura Knife
20 cm,



Adson
AS-8-126-20
Dura Hook
20 cm,



Graham
AS-8-127-16
Dura Hook blunt
16.5 cm,



Sachs
AS-8-128-18
Dura Hook sharp
18 cm,



Toennis
AS-8-129-15
Dura Hook sharp
14.5 cm,



Frazier
AS-8-130-13
Dura Hook sharp
13 cm, 18 cm,



Krayenbuhl
AS-8-131-01
Nerve and Vessel Hooklet
18.5 cm Fig. 1, 18.5 cm Fig. 2,



Cloward
AS-8-132-16
 Lamina Spreader
 16 cm,

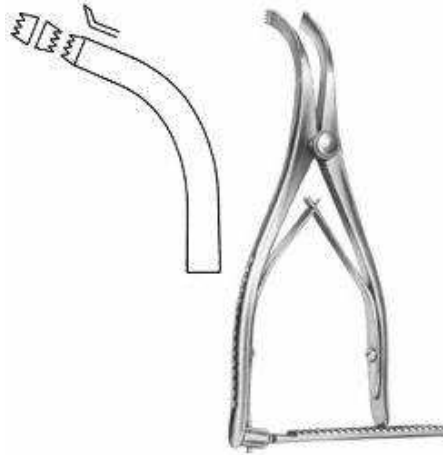

Inge
AS-8-133-17
 Lamina Spreader
 16 cm,

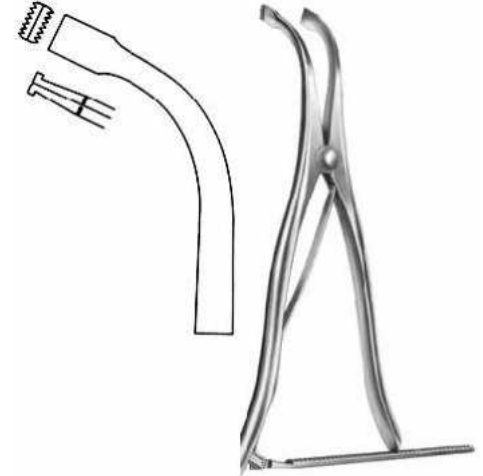

Inge
AS-8-134-27
 Lamina Spreader
 25.5 cm,

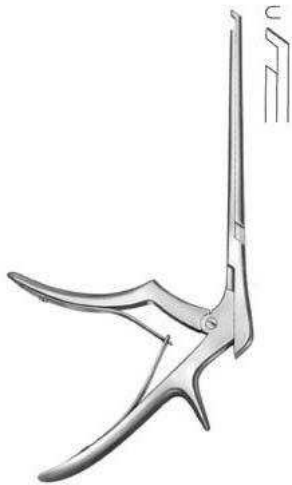

Ferris-Smith Kerrison
AS-8-135-03
 Laminectomy Punch 3mm downwards cutting
 40 degree shaft length 180 mm

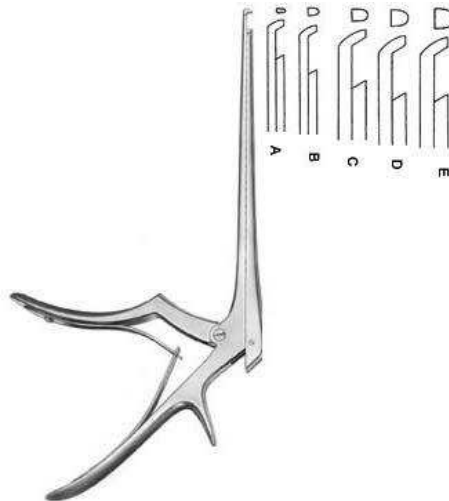

Ferris-Smith Kerrison
AS-8-138-01
 Laminectomy Punch upwards cutting shaft
 length 180 mm
 1 mm, 2 mm, 3 mm, 4 mm, 5 mm, 6 mm,

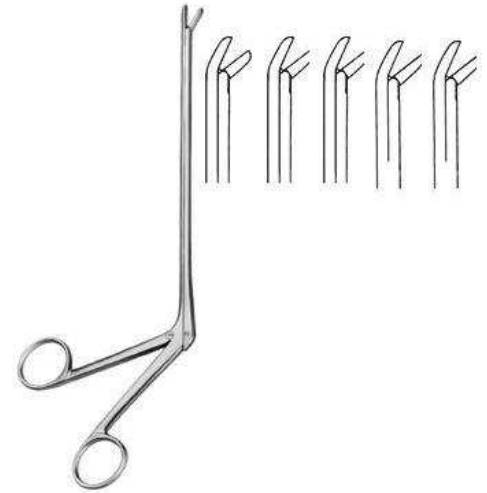

Cushing
AS-8-139-01
 Laminectomy Rongeur jaw 2 x 10 to 4 x 10
 mm straight shaft length 180 mm

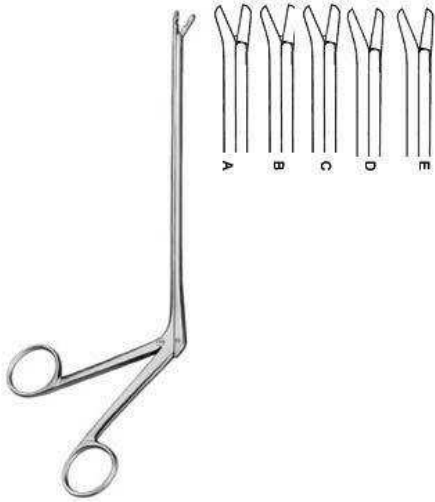

Cushing
AS-8-140-01

Laminectomy Rongeur jaw 2 x 10 to 4 x 10 mm upwards 45 degree shaft length 120 mm

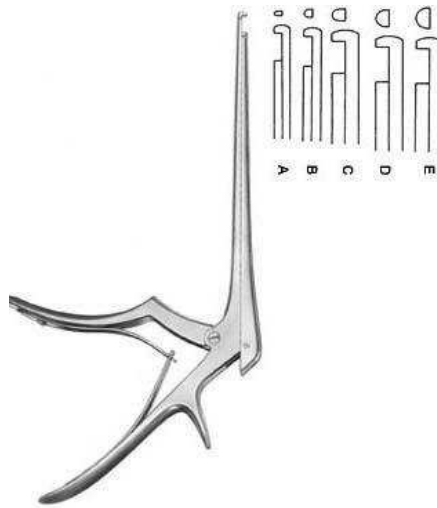

Ferris-Smith Kerrison
AS-8-137-01

Laminectomy Punch
1 mm, 2 mm, 3 mm, 4 mm, 5 mm, 6 mm,

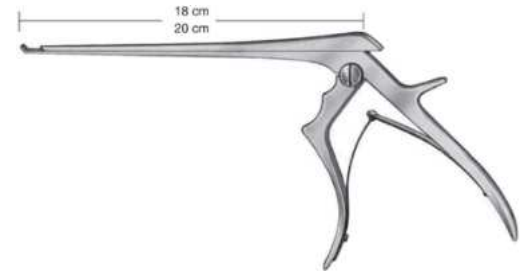

FERRIS-SMITH-KERRISON
AS-9-137-01
with thin footplate

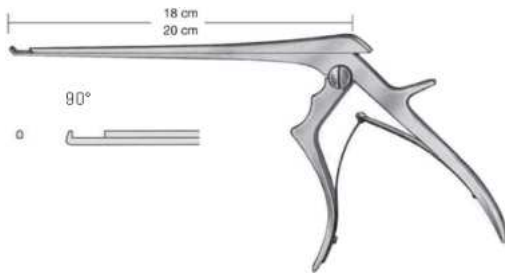

FERRIS-SMITH-KERRISON
AS-9-137-02

With thin footplate
18 cm , 20 cm , 1mm , 2 mm , 3 mm , 4 mm , 5 mm,

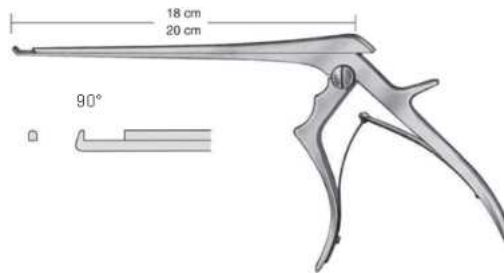

FERRIS-SMITH-KERRISON
AS-9-137-03

With thin footplate
18 cm , 20 cm , 1mm , 2 mm, 3 mm , 4 mm , 5 mm,

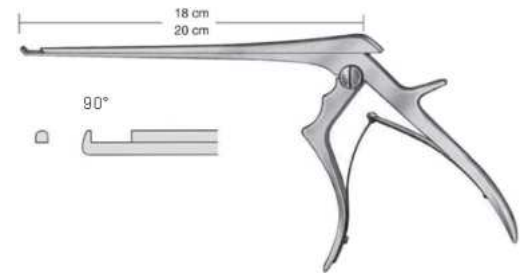

FERRIS-SMITH-KERRISON
AS-9-137-04

With thin footplate
18 cm , 20 cm , 1mm , 2 mm, 3 mm , 4 mm , 5 mm,

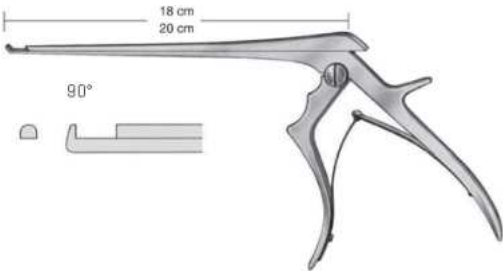

FERRIS-SMITH-KERRISON
AS-9-137-05

With thin footplate

18 cm , 20 cm , 1 mm , 2 mm, 3 mm , 4 mm , 5 mm,

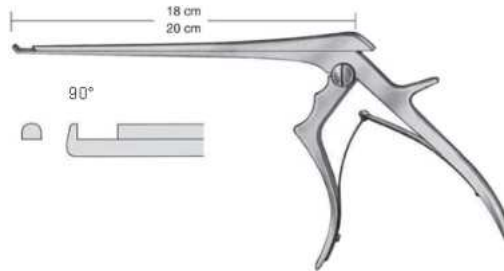

FERRIS-SMITH-KERRISON
AS-9-137-06

With thin footplate

18 cm , 20 cm , 1 mm , 2 mm, 3 mm , 4 mm , 5 mm,

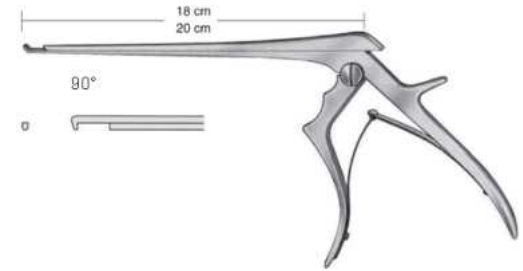

FERRIS-SMITH-KERRISON
AS-9-137-07

with thin footplate

18 cm , 20 cm , 1 mm, 2 mm, 3 mm, 4 mm, 5 mm,

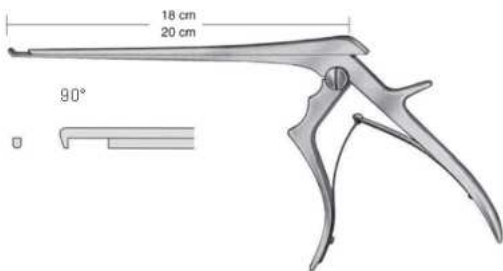

FERRIS-SMITH-KERRISON
AS-9-137-08

with thin footplate

18 cm , 20 cm , 1 mm, 2 mm, 3 mm, 4 mm, 5 mm,

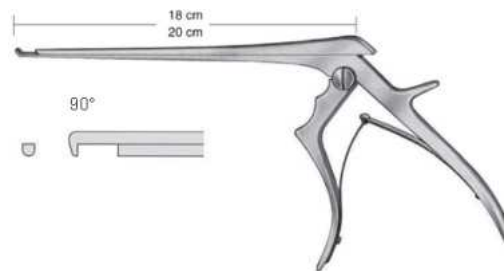

FERRIS-SMITH-KERRISON
AS-9-137-09

with thin footplate

18 cm , 20 cm , 1 mm, 2 mm, 3 mm, 4 mm, 5 mm,

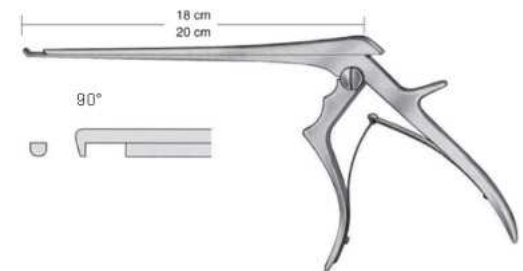

FERRIS-SMITH-KERRISON
AS-9-137-10

with thin footplate

18 cm , 20 cm , 1 mm, 2 mm, 3 mm, 4 mm, 5 mm,

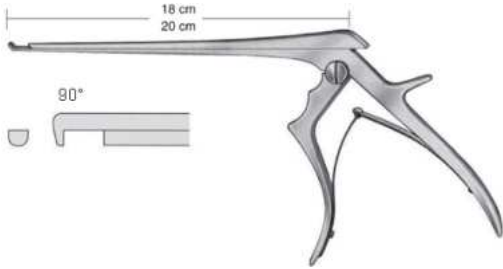

FERRIS-SMITH-KERRISON

AS-9-137-11

with thin footplate

18 cm , 20 cm , 1 mm,2 mm,3 mm,4 mm,5 mm,

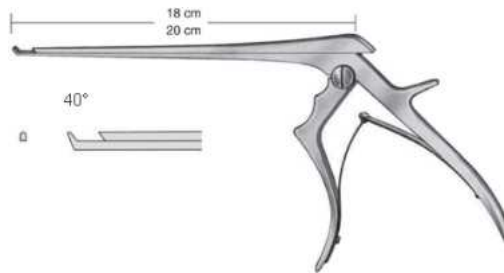

FERRIS-SMITH-KERRISON

AS-9-137-12

with thin footplate

1 mm,2 mm,3 mm,4 mm,5 mm,

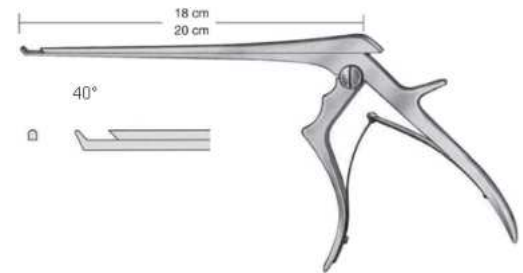

FERRIS-SMITH-KERRISON

AS-9-137-13

with thin footplate

1 mm,2 mm,3 mm,4 mm,5 mm,

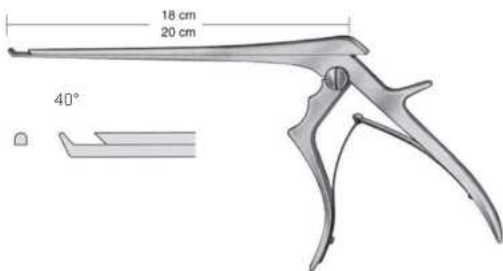

FERRIS-SMITH-KERRISON

AS-9-137-14

with thin footplate

1 mm,2 mm,3 mm,4 mm,5 mm,

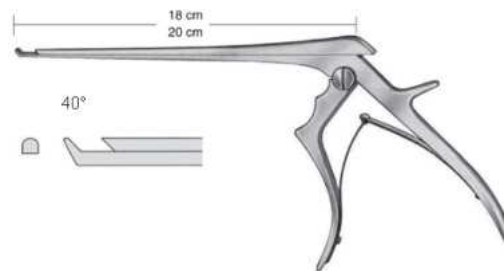

FERRIS-SMITH-KERRISON

AS-9-137-15

with thin footplate

1 mm,2 mm,3 mm,4 mm,5 mm,

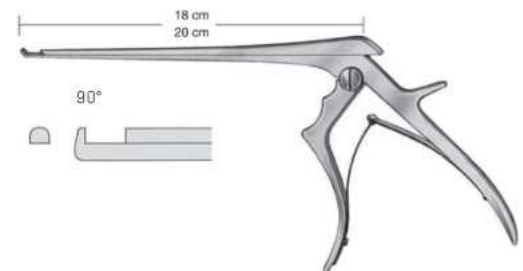

FERRIS-SMITH-KERRISON

AS-9-137-16

with thin footplate

1 mm,2 mm,3 mm,4 mm,5 mm,

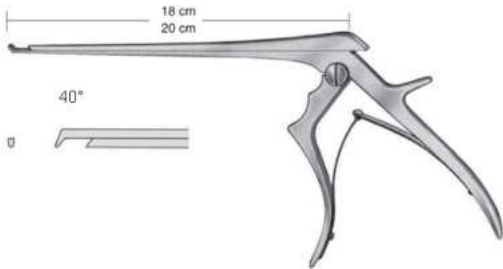

FERRIS-SMITH-KERRISON
AS-9-137-17
 with thin footplate
 1 mm,2 mm,3 mm,4 mm,5 mm,

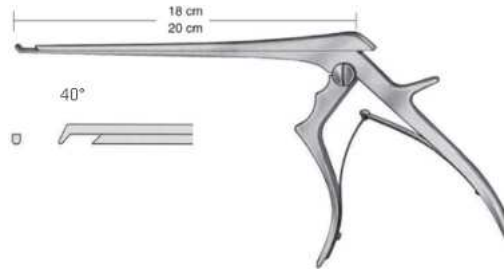

FERRIS-SMITH-KERRISON
AS-9-137-18
 with thin footplate
 1 mm,2 mm,3 mm,4 mm,5 mm,

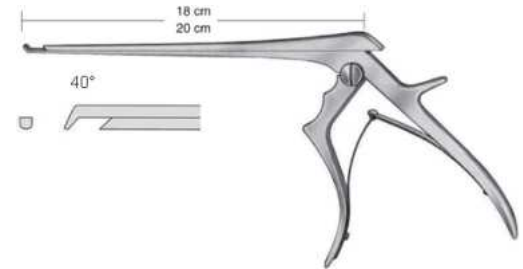

FERRIS-SMITH-KERRISON
AS-9-137-19
 with thin footplate
 1 mm,2 mm,3 mm,4 mm,5 mm,

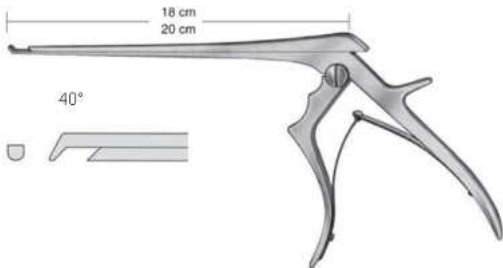

FERRIS-SMITH-KERRISON
AS-9-137-20
 with thin footplate
 1 mm,2 mm,3 mm,4 mm,5 mm,

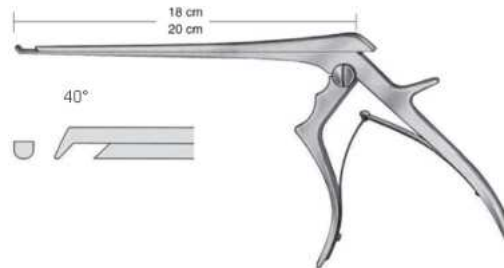

FERRIS-SMITH-KERRISON
AS-9-137-21
 with thin footplate
 1 mm,2 mm,3 mm,4 mm,5 mm,



AS-9-137-22
 18 cm,20 cm ,



AS-9-137-23

18 cm , 20 cm , 1mm,2 mm,3 mm,4 mm,5 mm,6 mm,



AS-9-137-24

18 cm , 20 cm , 1mm,2 mm,3 mm,4 mm,5 mm,6 mm,



AS-9-137-25

18 cm , 20 cm , 1mm,2 mm,3 mm,4 mm,5 mm,6 mm,

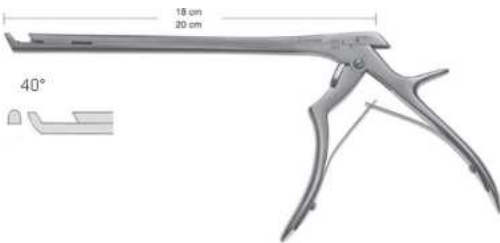

AS-9-137-26

18 cm , 20 cm , 1mm,2 mm,3 mm,4 mm,5 mm,6 mm,



AS-9-137-27

18 cm , 20 cm , 1mm,2 mm,3 mm,4 mm,5 mm,6 mm,



AS-9-137-28

18 cm , 20 cm , 1mm,2 mm,3 mm,4 mm,5 mm,6 mm,

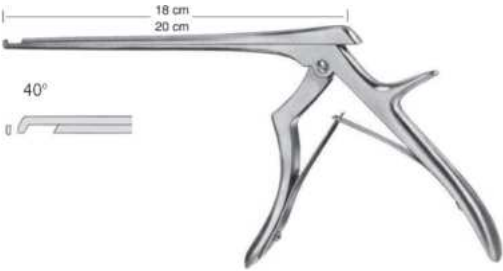

AS-9-137-29

18 cm , 20 cm , 1mm,2 mm,3 mm,4 mm,5 mm,6 mm,

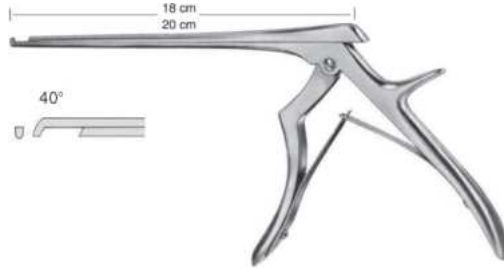

AS-9-137-30

18 cm , 20 cm , 1mm,2 mm,3 mm,4 mm,5 mm,6 mm,

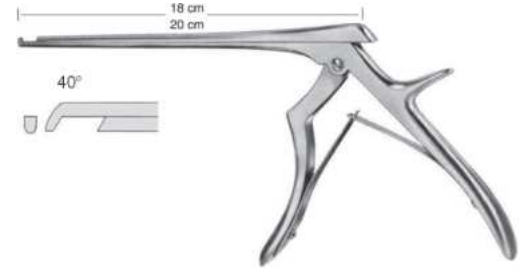

AS-9-137-31

18 cm , 20 cm , 1mm,2 mm,3 mm,4 mm,5 mm,6 mm,

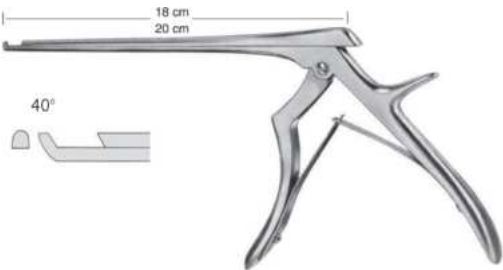

AS-9-137-32

18 cm , 20 cm , 1mm,2 mm,3 mm,4 mm,5 mm,6 mm,

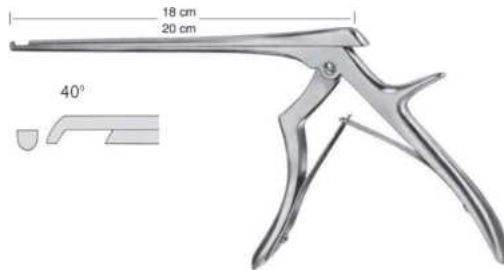

AS-9-137-33

18 cm , 20 cm , 1mm,2 mm,3 mm,4 mm,5 mm,6 mm,

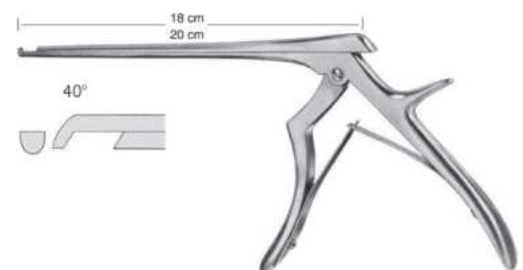

AS-9-137-34

18 cm , 20 cm , 1mm,2 mm,3 mm,4 mm,5 mm,6 mm,



detachable
AS-9-137-35
detachable

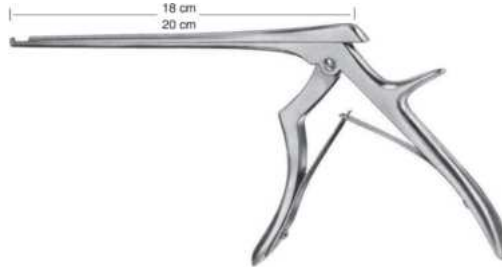

FERRIS-SMITH-KERRISON
AS-9-137-36
FERRIS-SMITH-KERRISON

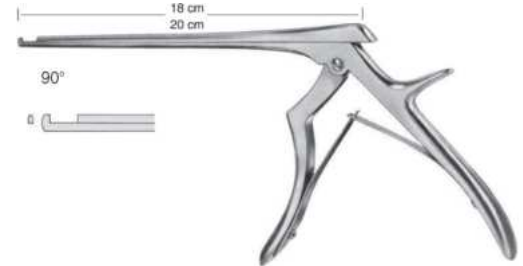

FERRIS-SMITH-KERRISON
AS-9-137-37
FERRIS-SMITH-KERRISON
18 cm , 20 cm ,
1mm,2mm,3mm,4mm,5mm,6mm,

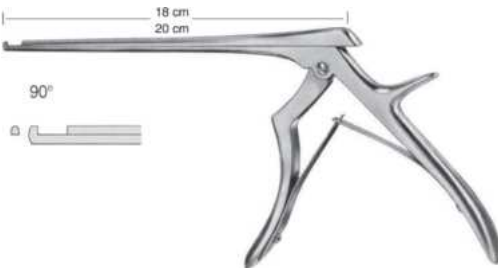

FERRIS-SMITH-KERRISON
AS-9-137-38
FERRIS-SMITH-KERRISON

18 cm , 20 cm , 1mm,18 cm , 20 cm ,
2mm,18 cm , 20 cm , 3mm,18 cm , 20 cm ,
4mm,18 cm , 20 cm , 5mm,18 cm , 20 cm ,
6mm,

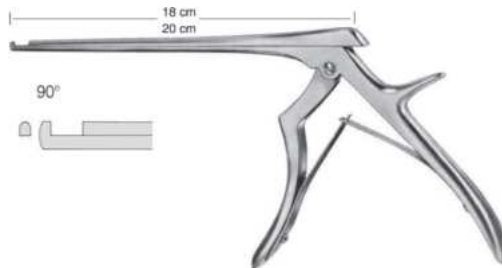

FERRIS-SMITH-KERRISON
AS-9-137-39
FERRIS-SMITH-KERRISON

18 cm , 20 cm , 1mm,18 cm , 20 cm ,
2mm,18 cm , 20 cm , 3mm,18 cm , 20 cm ,
4mm,18 cm , 20 cm , 5mm,18 cm , 20 cm ,
6mm,

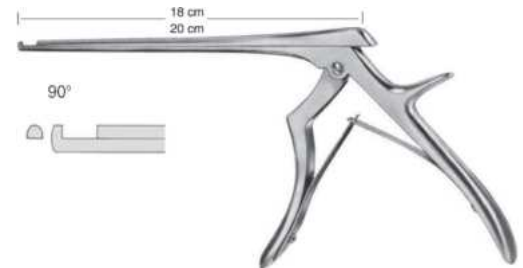

FERRIS-SMITH-KERRISON
AS-9-137-40
FERRIS-SMITH-KERRISON

18 cm , 20 cm , 1mm,18 cm , 20 cm ,
2mm,18 cm , 20 cm , 3mm,18 cm , 20 cm ,
4mm,18 cm , 20 cm , 5mm,18 cm , 20 cm ,
6mm,

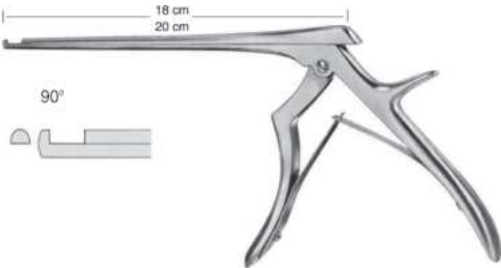

FERRIS-SMITH-KERRISON
AS-9-137-41

FERRIS-SMITH-KERRISON

18 cm , 20 cm , 1mm,18 cm , 20 cm ,
2mm,18 cm , 20 cm , 3mm,18 cm , 20 cm ,
4mm,18 cm , 20 cm , 5mm,18 cm , 20 cm ,
6mm,

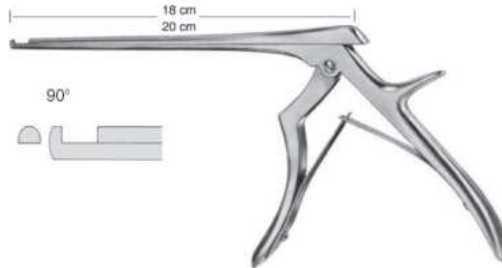

FERRIS-SMITH-KERRISON
AS-9-137-42

FERRIS-SMITH-KERRISON

18 cm , 20 cm , 1mm,18 cm , 20 cm ,
2mm,18 cm , 20 cm , 3mm,18 cm , 20 cm ,
4mm,18 cm , 20 cm , 5mm,18 cm , 20 cm ,
6mm,

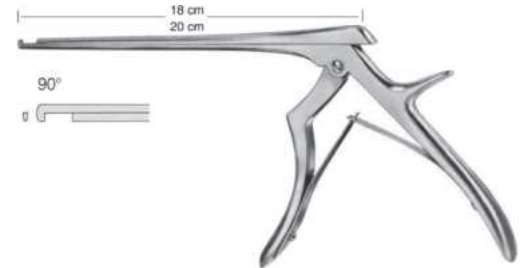

FERRIS-SMITH-KERRISON
AS-9-137-43

FERRIS-SMITH-KERRISON

18 cm , 20 cm , 1mm,18 cm , 20 cm ,
2mm,18 cm , 20 cm , 3mm,18 cm , 20 cm ,
4mm,18 cm , 20 cm , 5mm,18 cm , 20 cm ,
6mm,

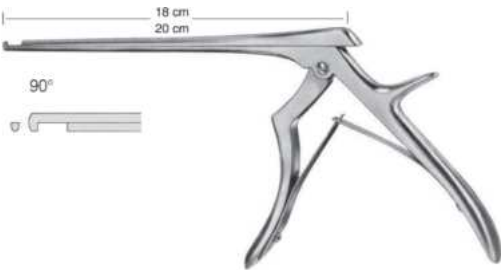

FERRIS-SMITH-KERRISON
AS-9-137-44

FERRIS-SMITH-KERRISON

18 cm , 20 cm , 1mm,18 cm , 20 cm ,
2mm,18 cm , 20 cm , 3mm,18 cm , 20 cm ,
4mm,18 cm , 20 cm , 5mm,18 cm , 20 cm ,
6mm,

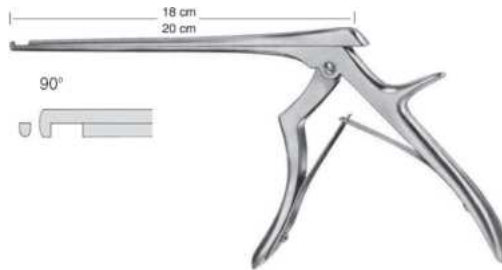

FERRIS-SMITH-KERRISON
AS-9-137-45

FERRIS-SMITH-KERRISON

18 cm , 20 cm , 1mm,18 cm , 20 cm ,
2mm,18 cm , 20 cm , 3mm,18 cm , 20 cm ,
4mm,18 cm , 20 cm , 5mm,18 cm , 20 cm ,
6mm,

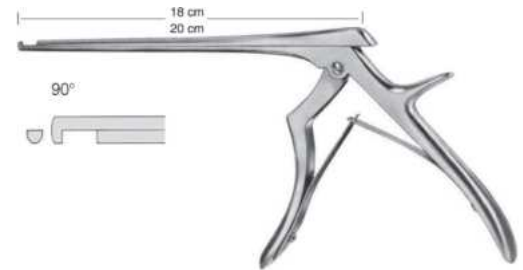

FERRIS-SMITH-KERRISON
AS-9-137-46

FERRIS-SMITH-KERRISON

18 cm , 20 cm , 1mm,18 cm , 20 cm ,
2mm,18 cm , 20 cm , 3mm,18 cm , 20 cm ,
4mm,18 cm , 20 cm , 5mm,18 cm , 20 cm ,
6mm,

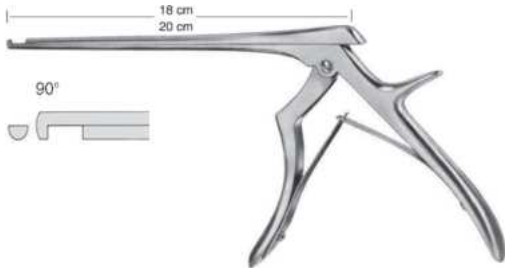

FERRIS-SMITH-KERRISON
AS-9-137-47

FERRIS-SMITH-KERRISON

18 cm , 20 cm , 1mm,18 cm , 20 cm ,
2mm,18 cm , 20 cm , 3mm,18 cm , 20 cm ,
4mm,18 cm , 20 cm , 5mm,18 cm , 20 cm ,
6mm,

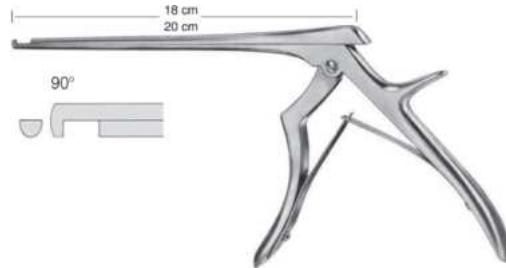

FERRIS-SMITH-KERRISON
AS-9-137-48

FERRIS-SMITH-KERRISON

18 cm , 20 cm , 1mm,18 cm , 20 cm ,
2mm,18 cm , 20 cm , 3mm,18 cm , 20 cm ,
4mm,18 cm , 20 cm , 5mm,18 cm , 20 cm ,
6mm,

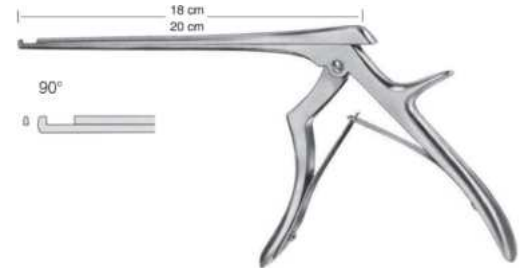

FERRIS-SMITH-KERRISON
AS-9-137-49

FERRIS-SMITH-KERRISON

18 cm , 20 cm , 1mm,18 cm , 20 cm ,
2mm,18 cm , 20 cm , 3mm,18 cm , 20 cm ,
4mm,18 cm , 20 cm , 5mm,18 cm , 20 cm ,
6mm,

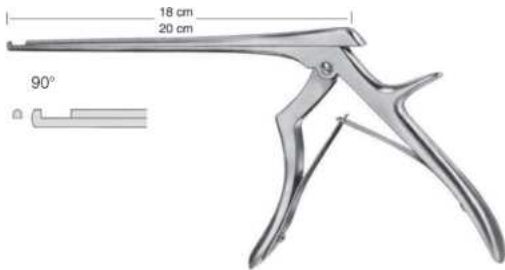

FERRIS-SMITH-KERRISON
AS-9-137-50

FERRIS-SMITH-KERRISON

18 cm , 20 cm , 1mm,18 cm , 20 cm ,
2mm,18 cm , 20 cm , 3mm,18 cm , 20 cm ,
4mm,18 cm , 20 cm , 5mm,18 cm , 20 cm ,
6mm,

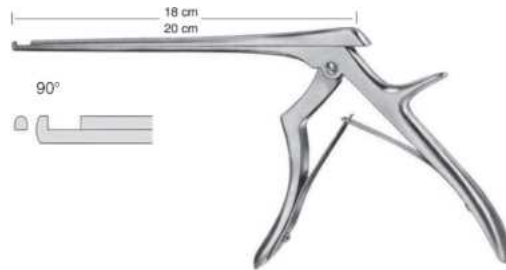

FERRIS-SMITH-KERRISON
AS-9-137-51

FERRIS-SMITH-KERRISON

18 cm , 20 cm , 1mm,18 cm , 20 cm ,
2mm,18 cm , 20 cm , 3mm,18 cm , 20 cm ,
4mm,18 cm , 20 cm , 5mm,18 cm , 20 cm ,
6mm,

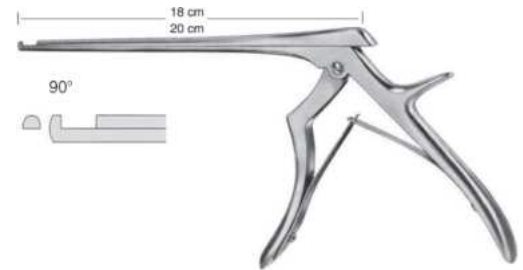

FERRIS-SMITH-KERRISON
AS-9-137-52

FERRIS-SMITH-KERRISON

18 cm , 20 cm , 1mm,18 cm , 20 cm ,
2mm,18 cm , 20 cm , 3mm,18 cm , 20 cm ,
4mm,18 cm , 20 cm , 5mm,18 cm , 20 cm ,
6mm,

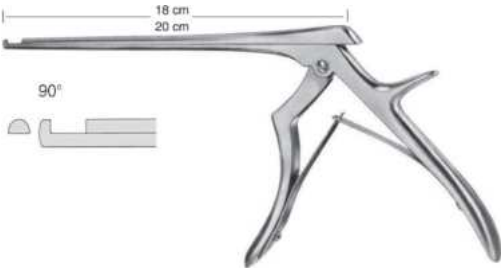

FERRIS-SMITH-KERRISON
AS-9-137-53

FERRIS-SMITH-KERRISON

18 cm , 20 cm , 1mm,18 cm , 20 cm ,
2mm,18 cm , 20 cm , 3mm,18 cm , 20 cm ,
4mm,18 cm , 20 cm , 5mm,18 cm , 20 cm ,
6mm,

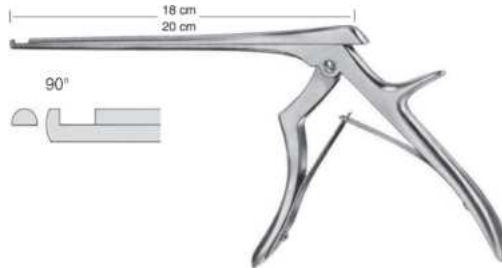

FERRIS-SMITH-KERRISON
AS-9-137-54

FERRIS-SMITH-KERRISON

18 cm , 20 cm , 1mm,18 cm , 20 cm ,
2mm,18 cm , 20 cm , 3mm,18 cm , 20 cm ,
4mm,18 cm , 20 cm , 5mm,18 cm , 20 cm ,
6mm,

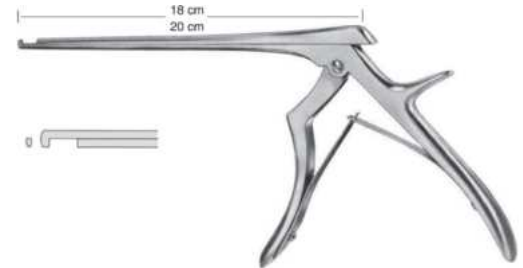

FERRIS-SMITH-KERRISON
AS-9-137-55

FERRIS-SMITH-KERRISON

18 cm , 20 cm , 1mm,18 cm , 20 cm ,
2mm,18 cm , 20 cm , 3mm,18 cm , 20 cm ,
4mm,18 cm , 20 cm , 5mm,18 cm , 20 cm ,
6mm,

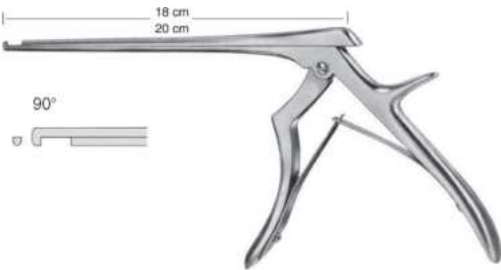

FERRIS-SMITH-KERRISON
AS-9-137-56

FERRIS-SMITH-KERRISON

18 cm , 20 cm , 1mm,18 cm , 20 cm ,
2mm,18 cm , 20 cm , 3mm,18 cm , 20 cm ,
4mm,18 cm , 20 cm , 5mm,18 cm , 20 cm ,
6mm,

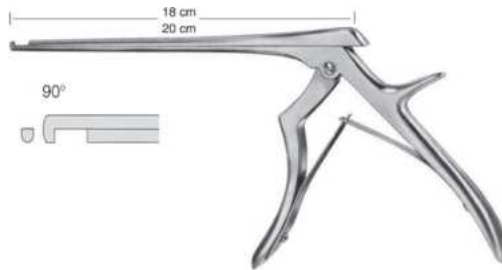

FERRIS-SMITH-KERRISON
AS-9-137-57

FERRIS-SMITH-KERRISON

18 cm , 20 cm , 1mm,18 cm , 20 cm ,
2mm,18 cm , 20 cm , 3mm,18 cm , 20 cm ,
4mm,18 cm , 20 cm , 5mm,18 cm , 20 cm ,
6mm,

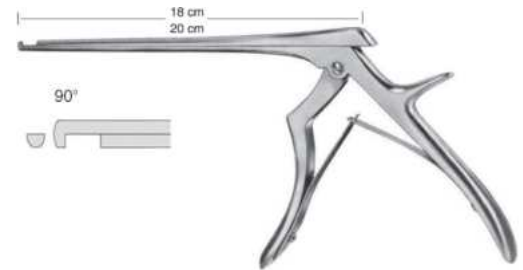

FERRIS-SMITH-KERRISON
AS-9-137-58

FERRIS-SMITH-KERRISON

18 cm , 20 cm , 1mm,18 cm , 20 cm ,
2mm,18 cm , 20 cm , 3mm,18 cm , 20 cm ,
4mm,18 cm , 20 cm , 5mm,18 cm , 20 cm ,
6mm,

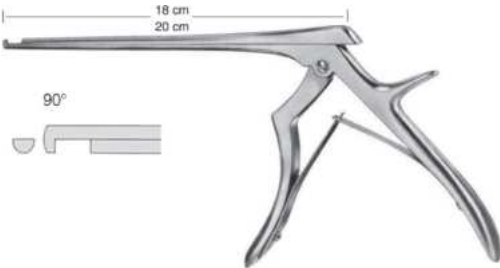

FERRIS-SMITH-KERRISON
AS-9-137-59

FERRIS-SMITH-KERRISON

18 cm , 20 cm , 1mm,18 cm , 20 cm ,
2mm,18 cm , 20 cm , 3mm,18 cm , 20 cm ,
4mm,18 cm , 20 cm , 5mm,18 cm , 20 cm ,
6mm,

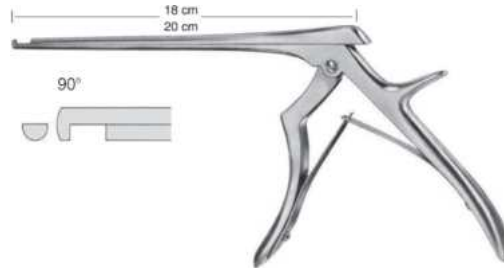

FERRIS-SMITH-KERRISON
AS-9-137-60

FERRIS-SMITH-KERRISON

18 cm , 20 cm , 1mm,18 cm , 20 cm ,
2mm,18 cm , 20 cm , 3mm,18 cm , 20 cm ,
4mm,18 cm , 20 cm , 5mm,18 cm , 20 cm ,
6mm,

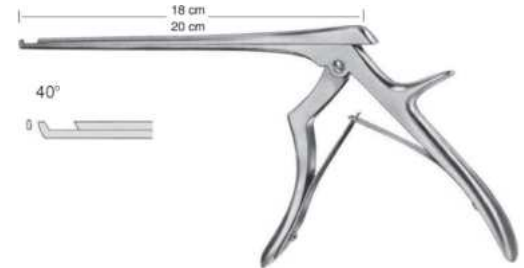

FERRIS-SMITH-KERRISON
AS-9-137-61

FERRIS-SMITH-KERRISON

18 cm , 20 cm , 1mm,18 cm , 20 cm ,
2mm,18 cm , 20 cm , 3mm,18 cm , 20 cm ,
4mm,18 cm , 20 cm , 5mm,18 cm , 20 cm ,
6mm,

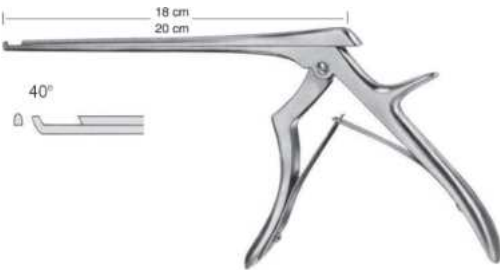

FERRIS-SMITH-KERRISON
AS-9-137-62

FERRIS-SMITH-KERRISON

18 cm , 20 cm , 1mm,18 cm , 20 cm ,
2mm,18 cm , 20 cm , 3mm,18 cm , 20 cm ,
4mm,18 cm , 20 cm , 5mm,18 cm , 20 cm ,
6mm,

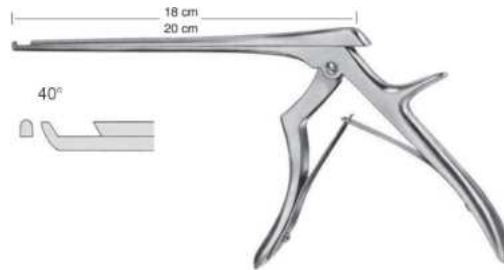

FERRIS-SMITH-KERRISON
AS-9-137-63

FERRIS-SMITH-KERRISON

18 cm , 20 cm , 1mm,18 cm , 20 cm ,
2mm,18 cm , 20 cm , 3mm,18 cm , 20 cm ,
4mm,18 cm , 20 cm , 5mm,18 cm , 20 cm ,
6mm,

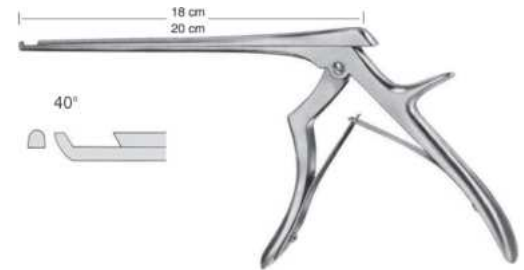

FERRIS-SMITH-KERRISON
AS-9-137-64

FERRIS-SMITH-KERRISON

18 cm , 20 cm , 1mm,18 cm , 20 cm ,
2mm,18 cm , 20 cm , 3mm,18 cm , 20 cm ,
4mm,18 cm , 20 cm , 5mm,18 cm , 20 cm ,
6mm,

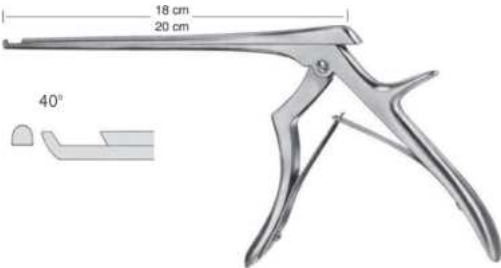

FERRIS-SMITH-KERRISON
AS-9-137-65

FERRIS-SMITH-KERRISON

18 cm , 20 cm , 1mm,18 cm , 20 cm ,
2mm,18 cm , 20 cm , 3mm,18 cm , 20 cm ,
4mm,18 cm , 20 cm , 5mm,18 cm , 20 cm ,
6mm,

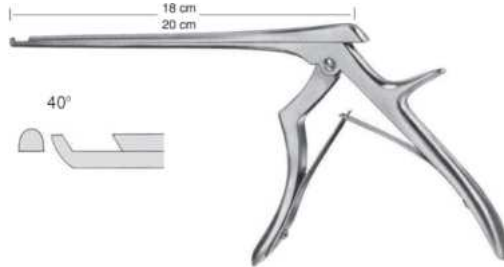

FERRIS-SMITH-KERRISON
AS-9-137-66

FERRIS-SMITH-KERRISON

18 cm , 20 cm , 1mm,18 cm , 20 cm ,
2mm,18 cm , 20 cm , 3mm,18 cm , 20 cm ,
4mm,18 cm , 20 cm , 5mm,18 cm , 20 cm ,
6mm,

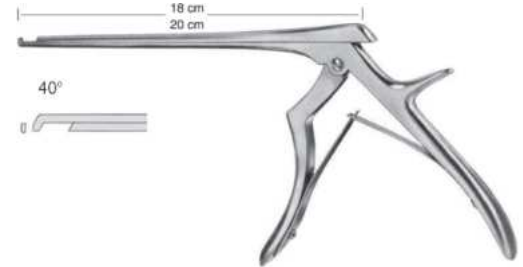

FERRIS-SMITH-KERRISON
AS-9-137-67

FERRIS-SMITH-KERRISON

18 cm , 20 cm , 1mm,18 cm , 20 cm ,
2mm,18 cm , 20 cm , 3mm,18 cm , 20 cm ,
4mm,18 cm , 20 cm , 5mm,18 cm , 20 cm ,
6mm,

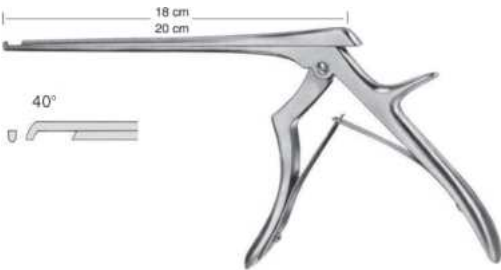

FERRIS-SMITH-KERRISON
AS-9-137-68

FERRIS-SMITH-KERRISON

18 cm , 20 cm , 1mm,18 cm , 20 cm ,
2mm,18 cm , 20 cm , 3mm,18 cm , 20 cm ,
4mm,18 cm , 20 cm , 5mm,18 cm , 20 cm ,
6mm,

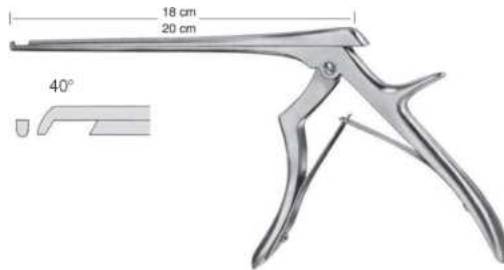

FERRIS-SMITH-KERRISON
AS-9-137-69

FERRIS-SMITH-KERRISON

18 cm , 20 cm , 1mm,18 cm , 20 cm ,
2mm,18 cm , 20 cm , 3mm,18 cm , 20 cm ,
4mm,18 cm , 20 cm , 5mm,18 cm , 20 cm ,
6mm,

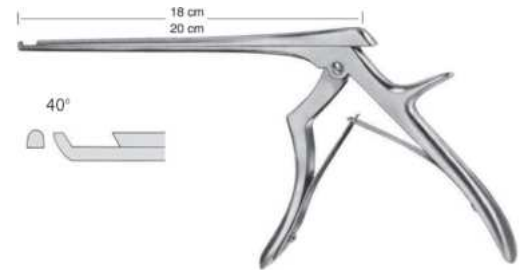

FERRIS-SMITH-KERRISON
AS-9-137-70

FERRIS-SMITH-KERRISON

18 cm , 20 cm , 1mm,18 cm , 20 cm ,
2mm,18 cm , 20 cm , 3mm,18 cm , 20 cm ,
4mm,18 cm , 20 cm , 5mm,18 cm , 20 cm ,
6mm,



FERRIS-SMITH-KERRISON
AS-9-137-71

FERRIS-SMITH-KERRISON

18 cm , 20 cm , 1mm,18 cm , 20 cm ,
2mm,18 cm , 20 cm , 3mm,18 cm , 20 cm ,
4mm,18 cm , 20 cm , 5mm,18 cm , 20 cm ,
6mm,

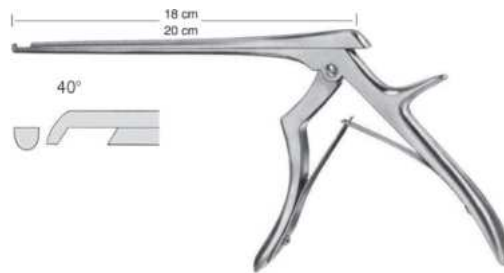

FERRIS-SMITH-KERRISON
AS-9-137-72

FERRIS-SMITH-KERRISON

18 cm , 20 cm , 1mm,18 cm , 20 cm ,
2mm,18 cm , 20 cm , 3mm,18 cm , 20 cm ,
4mm,18 cm , 20 cm , 5mm,18 cm , 20 cm ,
6mm,

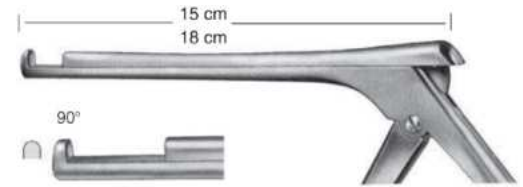

COLCLOUGH
AS-9-137-73

COLCLOUGH

3 mm
5 mm
15 cm,18 cm,

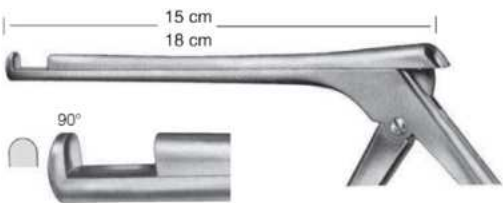

COLCLOUGH
AS-9-137-74

COLCLOUGH

3 mm
5 mm
15 cm,18 cm,



COLCLOUGH
AS-9-137-75

COLCLOUGH

3 mm
5 mm
20 cm,



COLCLOUGH
AS-9-137-76

COLCLOUGH

3 mm
5 mm
20 cm,

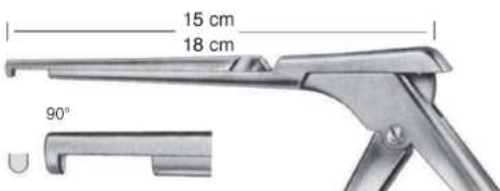

COLCLOUGH
AS-9-137-77
 COLCLOUGH
 3 mm
 5 mm
 15 cm, 18 cm,

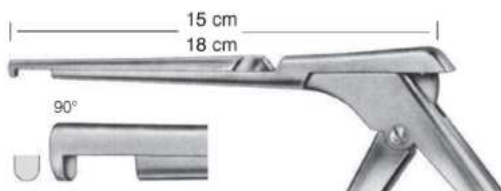

COLCLOUGH
AS-9-137-78
 COLCLOUGH
 3 mm
 5 mm
 15 cm, 18 cm,

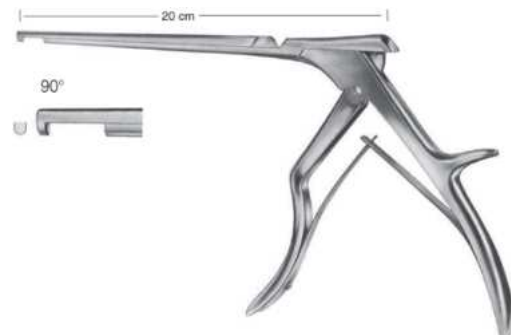

COLCLOUGH
AS-9-137-79
 COLCLOUGH
 3 mm
 5 mm
 20 cm,

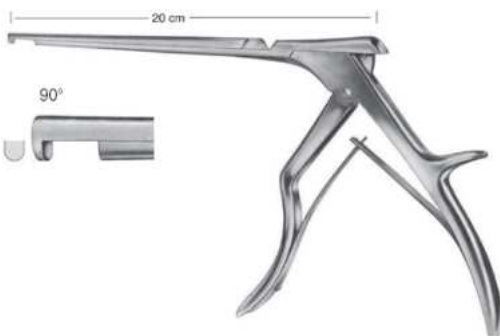

COLCLOUGH
AS-9-137-80
 COLCLOUGH
 3 mm
 5 mm
 20 cm,



COLCLOUGH
AS-9-137-81
 COLCLOUGH
 3 mm
 5 mm
 15 cm, 18 cm,



COLCLOUGH
AS-9-137-82
 COLCLOUGH
 3 mm
 5 mm
 15 cm, 18 cm,



COLCLOUGH
AS-9-137-83
 COLCLOUGH
 3 mm
 5 mm
 20 cm,

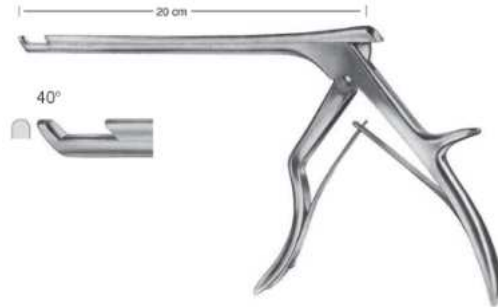

COLCLOUGH
AS-9-137-84
 COLCLOUGH
 3 mm
 5 mm
 20 cm,



RANEY
AS-9-137-85
 RANEY
 15 cm / 6mm, 18 cm / 6mm,

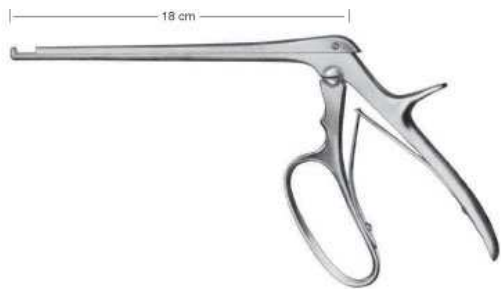

FERRIS-SMITH-KERRISON
AS-9-137-86
 FERRIS-SMITH-KERRISON
 18 cm,

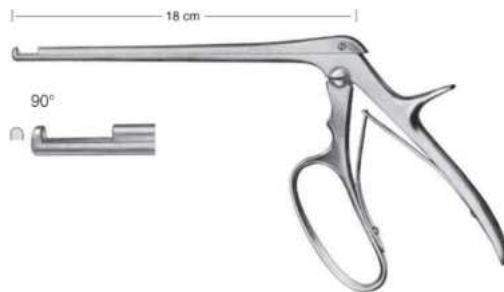

FERRIS-SMITH-KERRISON
AS-9-137-87
 FERRIS-SMITH-KERRISON
 3x3 mm,

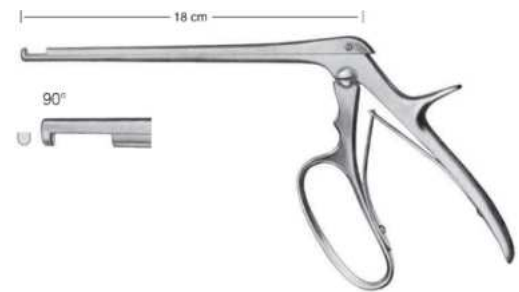

FERRIS-SMITH-KERRISON
AS-9-137-88
 FERRIS-SMITH-KERRISON
 3x3 mm,

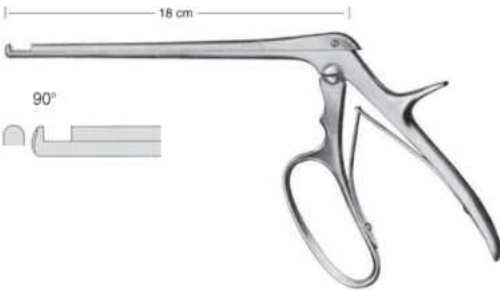

FERRIS-SMITH-KERRISON
AS-9-137-89
 FERRIS-SMITH-KERRISON
 5x5 mm,

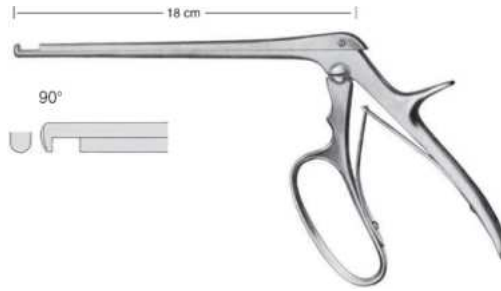

FERRIS-SMITH-KERRISON
AS-9-137-90
 FERRIS-SMITH-KERRISON
 5x5 mm,

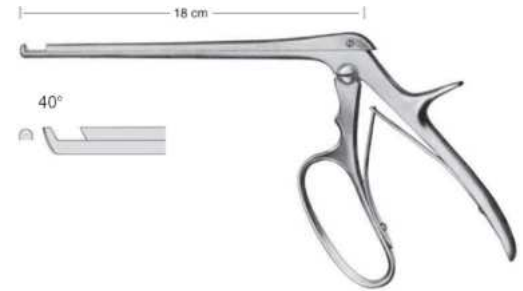

FERRIS-SMITH-KERRISON
AS-9-137-91
 FERRIS-SMITH-KERRISON
 3 mm,

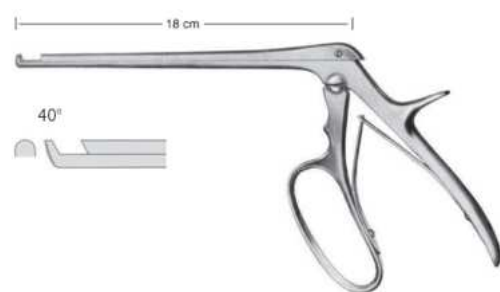

FERRIS-SMITH-KERRISON
AS-9-137-92
 FERRIS-SMITH-KERRISON
 5 mm,

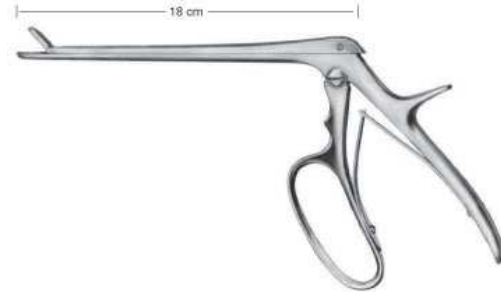

FERRIS-SMITH-CUSHING
AS-9-137-93
 FERRIS-SMITH-CUSHING
 18 cm,

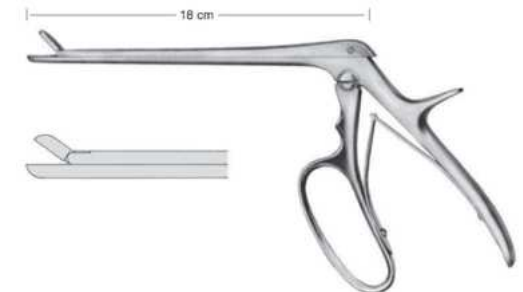

FERRIS-SMITH-CUSHING
AS-9-137-94
 FERRIS-SMITH-CUSHING
 2 x 10 mm, 3 x 10 mm, 4 x 10 mm, 5 x 10
 mm, 6 x 10 mm,

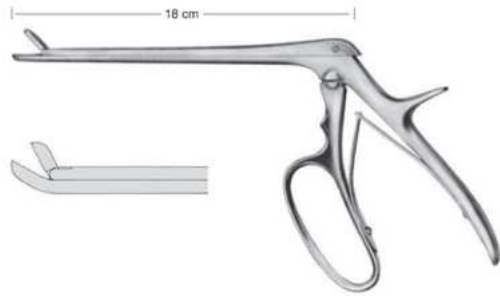

FERRIS-SMITH-CUSHING

AS-9-137-95

FERRIS-SMITH-CUSHING

2 x 10 mm, 3 x 10 mm, 4 x 10 mm, 5 x 10 mm, 6 x 10 mm,

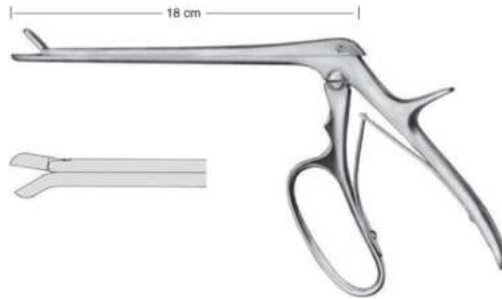

FERRIS-SMITH-CUSHING

AS-9-137-96

FERRIS-SMITH-CUSHING

2 x 10 mm, 3 x 10 mm, 4 x 10 mm, 5 x 10 mm, 6 x 10 mm,



CUSHING

AS-9-137-97

CUSHING

CUSHING

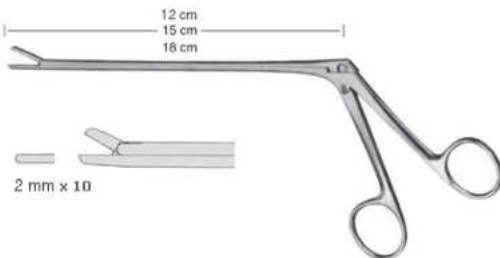

CUSHING

AS-9-137-98

CUSHING

2 mm x 10, 12 cm, 15 cm, 18 cm,

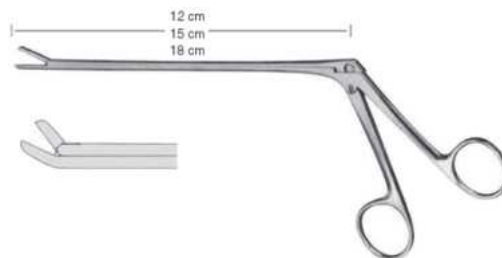

CUSHING

AS-9-137-99

CUSHING

2 mm x 10, 12 cm, 15 cm, 18 cm,

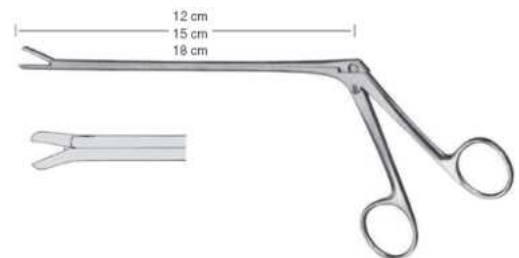

CUSHING

AS-9-137-100

CUSHING

2 mm x 10, 12 cm, 15 cm, 18 cm,

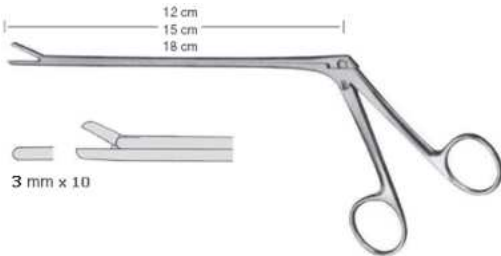

LOVE-GRUENWALD
AS-9-137-101
 LOVE-GRUENWALD
 3 mm x 10,12 cm,15 cm,18 cm,

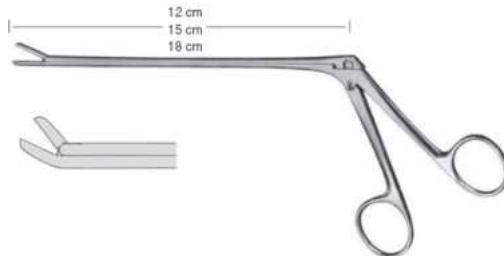

LOVE-GRUENWALD
AS-9-137-102
 LOVE-GRUENWALD
 3 mm x 10,12 cm,15 cm,18 cm,

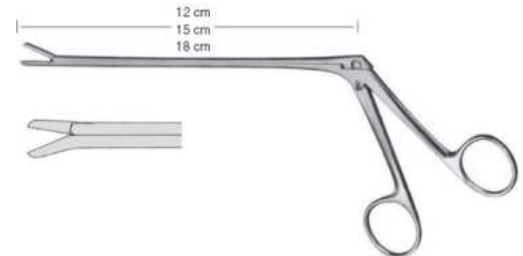

LOVE-GRUENWALD
AS-9-137-103
 LOVE-GRUENWALD
 3 mm x 10,12 cm,15 cm,18 cm,

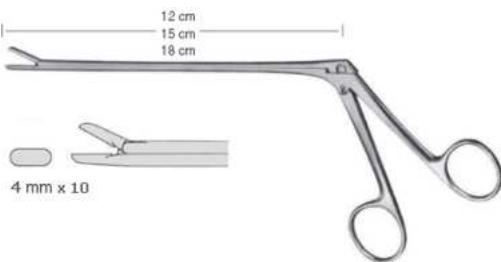

SPURLING
AS-9-137-104
 SPURLING
 4 mm x 10,12 cm,15 cm,18 cm,



SPURLING
AS-9-137-105
 SPURLING
 4 mm x 10,12 cm,15 cm,18 cm,



SPURLING
AS-9-137-106
 SPURLING
 4 mm x 10,12 cm,15 cm,18 cm,



OLDBERG
AS-9-137-107
OLDBERG
18 cm,



SCHLESINGER
AS-9-137-108
SCHLESINGER
15 cm, 2 x 10 mm, 3 x 10 mm, 4 x 10 mm, 5 x 10 mm,



CASPAR
AS-9-137-109
CASPAR
2 mm, 14 cm, 15 cm, 16 cm, 18.5 cm,



CASPAR
AS-9-137-110
CASPAR
3 mm, 14 cm, 15 cm, 16 cm, 18.5 cm,



CASPAR
AS-9-137-111
CASPAR
4 mm, 14 cm, 15 cm, 16 cm, 18.5 cm,



CASPAR
AS-9-137-112
CASPAR
5 mm, 14 cm, 15 cm, 16 cm, 18.5 cm,



CASPAR
AS-9-137-113
CASPAR

2 mm, 14 cm, 15 cm, 16 cm, 18.5 cm,



CASPAR
AS-9-137-114
CASPAR

3 mm, 14 cm, 15 cm, 16 cm, 18.5 cm,



CASPAR
AS-9-137-115
CASPAR

4 mm, 14 cm, 15 cm, 16 cm, 18.5 cm,



CASPAR
AS-9-137-116
CASPAR

2 mm, 14 cm, 15 cm, 16 cm, 18.5 cm,



CASPAR
AS-9-137-117
CASPAR

3 mm, 14 cm, 15 cm, 16 cm, 18.5 cm,



CASPAR
AS-9-137-118
CASPAR

4 mm, 14 cm, 15 cm, 16 cm, 18.5 cm,



YASARGIL
AS-9-137-119
YASARGIL

25 cm, 2.2 cm, 3.5 cm, 4.0 cm,



LANDOLT
AS-9-137-120
LANDOLT

27 cm, 9 mm,



OLIVECRONA-TOENNIS
AS-9-137-121

14 cm,



AS-9-101-23
Bone Shear
23 cm,



AS-9-102-22
Rib Shear
23 cm,



Gluck
AS-9-103-22
Rib Shears
21 cm,



Giertz-Stille
AS-9-104-27
Rib Shear
24.5 cm,



Lebsche
AS-9-105-24
Sternum Chisel
24.5 cm,



AS-9-106-01
Rib Retractor lateral blades 12 x 16 mm
spreading 95 mm
Size 1,



Finochietto, Infant
AS-9-107-01

Rib Retractor lateral blades 15 x 15 mm
spreading 75 mm
Size 1,



Finochietto, Baby
AS-9-108-01

Rib Retractor lateral blades 31 x 31 mm
spreading 100 mm
Size 1,



Finochietto
AS-9-109-01

Rib Retractor lateral blades 40 x 45 mm
spreading 135 mm
Size 1,



Burford
AS-9-110-01

Rib Retractor with two pairs of blades 47 x 62 mm + 65 x 62 mm, spreading 200 mm
Size 1,



Castaneda
AS-9-111-01

Rib Retractor lateral blades 10,5 x 32 mm
spreading 65 mm
Size 1,



Finochietto (modif.)
AS-9-112-01

Rib Retractor lateral blades 14 x 15 mm
spreading 120 mm
Size 1,



Haight

AS-9-113-90

Rib Retractor lateral blades 30 x 30 mm
spreading 120 mm
Size 1,



Morse-Favaloro

AS-9-114-01

Sternal Retractor 4 movable blades 17 x 22
mm spreading 160 mm Sternal Retractor
Size 1,



Morse

AS-9-115-00

Sternal Retractor 4 movable blades 22 x 27
mm spreading 200 mm
Size 1,



Tuffier

AS-9-116-02

Rib Retractor lateral blades 22 x 27 mm
spreading 200 mm
Size 1,

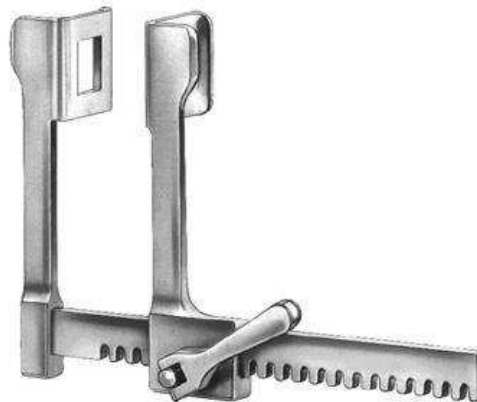

Finochietto, Baby

AS-9-117-75

Rib Retractor lateral blades 14 x 15 mm
spreading 75 mm
Size 1,



Finochietto

AS-9-118-01

Rib Retractor lateral blades 30 x 45 mm
spreading 150 mm
Size 1,

Cardiovascular



DeBakey
AS-9-119-00
Rib Retractor spreading 150 mm
Size 1,



DeBakey
AS-9-120-00
Rib Retractor spreading 200 mm
Size 1,



AS-9-121-00
Thoracic Retractor
Size 1,



Sellors
AS-9-122-19
Rib Contractor
20 cm,



Bailey-Baby
AS-9-123-14
Rib Contractor
15.5 cm,



Bailey
AS-9-124-16
Rib Contractor
20 cm,



Bailey-Gibbon
AS-9-125-16
 Rib Contractor
 20 cm,



Allison
AS-9-126-30
 Lung Spatula
 29.5 cm, 32.5 cm,

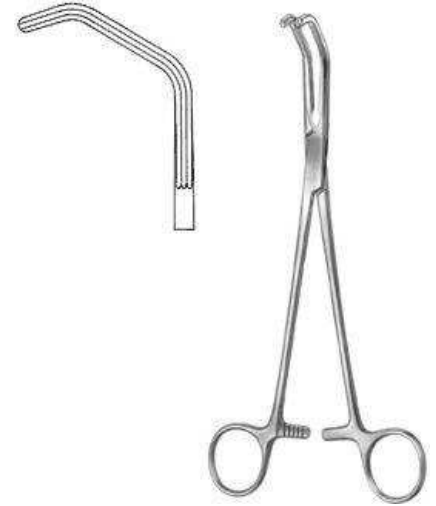

Price-Thomas
AS-9-127-22
 Bronchus Clamp
 22 cm,

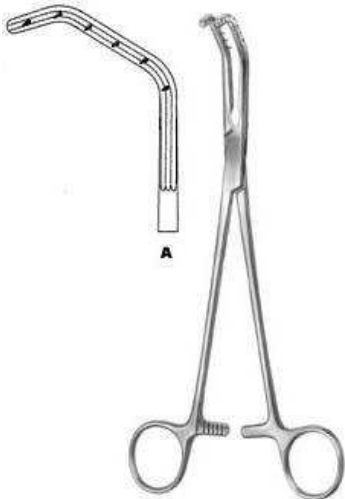

Price-Thomas
AS-9-128-22
 Bronchus Clamp
 22 cm,

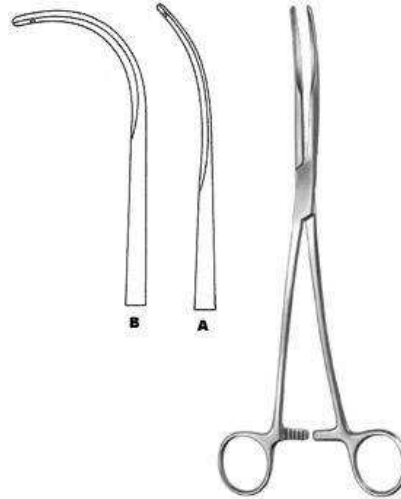

Semb
AS-9-129-24
 Bronchus Clamp
 24.5 cm,



Lovlace
AS-9-130-20
 Lung Grasping Forceps
 20.5 cm,



Lovelace
AS-9-131-20
Lung Grasping Forceps
19 cm,



DeBakey-Satinsky
AS-9-132-07
Bulldog Clamp
7 cm,9 cm,



Glover
AS-9-133-06
Bulldog Clamp
6 cm,



Santulli
AS-9-134-07
Bulldog Clamp
7 cm,



Gregory, soft
AS-9-135-09
Bulldog Clamp
9 cm,11 cm,



Gregory
AS-9-136-01
Bulldog Clamp
10.5 cm,



DeBakey-Rankin
AS-9-137-16
 Haemostatic Forceps
 16 cm,



DeBakey-Mosquito
AS-9-138-15
 Haemostatic Forceps
 15 cm,



Ochsner
AS-9-139-23
 Aortic Clamp
 23.5 cm,



Diethrich
AS-9-140-21
 Aortic Clamp
 22 cm,

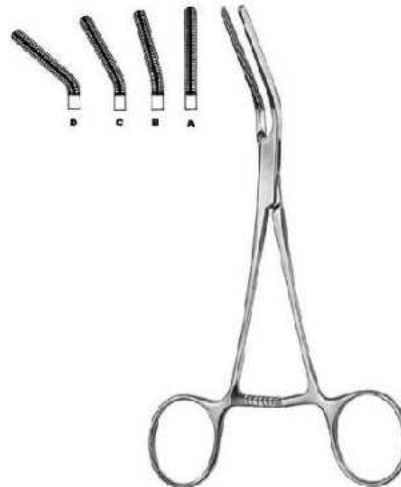

Dardik
AS-9-141-00
 Multi purpose Vascular Clamp
 15 cm,



Dale
AS-9-142-18
 Peripheral Vascular Clamp
 18 cm,

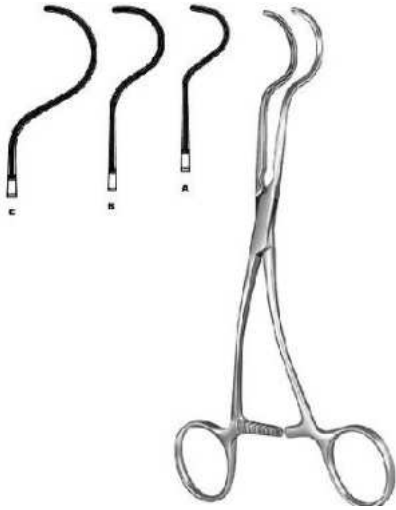

Dale
AS-9-143-17
Peripheral Vascular Clamp
17.5 cm,

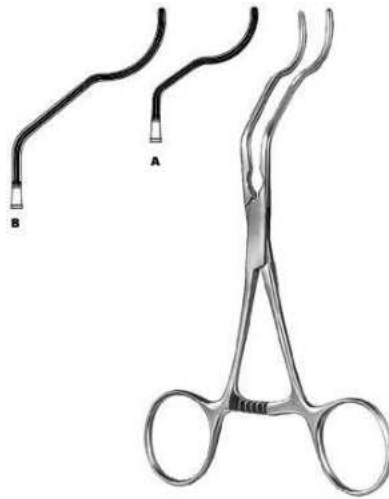

Gregory
AS-9-144-14
Profunda Clamp 13
cm, 16 cm, 18 cm,

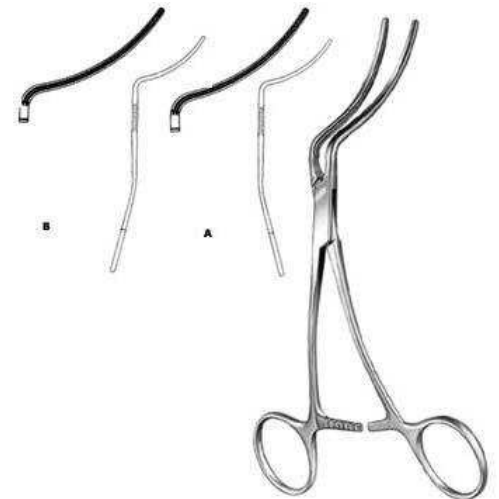

Martin
AS-9-145-16
Peripheral Vascular Clamp
16.5 cm,



Husfeldt
AS-9-146-18
Peripheral Vascular Clamp
17.5 cm,



Husfeldt
AS-9-147-18
Peripheral Vascular Clamp
18 cm,



Husfeldt
AS-9-148-17
Peripheral Vascular Clamp
17 cm,



DeBakey
AS-9-149-16
Vascular Forceps
16 cm,



DeBakey
AS-9-150-16
Vascular Forceps
16 cm,



DeBakey
AS-9-151-16
Vascular Forceps
16 cm,

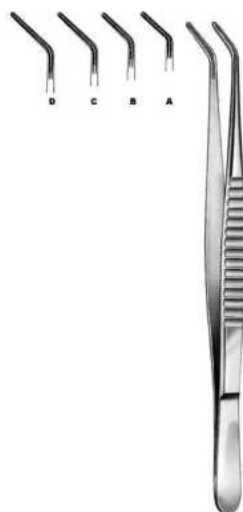

DeBakey
AS-9-152-16
Vascular Forceps
16 cm,



DeBakey
AS-9-153-16
Vascular Forceps
16 cm,



DeBakey
AS-9-154-07
Bulldog Clamp
7.5 cm,



DeBakey
AS-9-155-07
Bulldog Clamp
7.5 cm,



AS-9-156-23
Applying Forceps
23.5 cm,



Glover
AS-9-157-06
Bulldog Clamp
7 cm,



Glover
AS-9-158-06
Bulldog Clamp
6.5 cm,

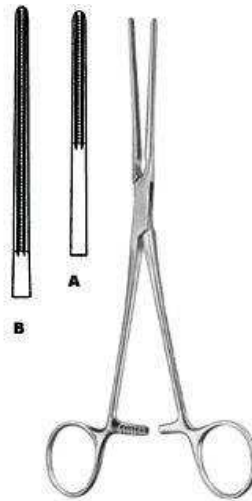

Potts
AS-9-159-21
Coarctation Clamp
21 cm,

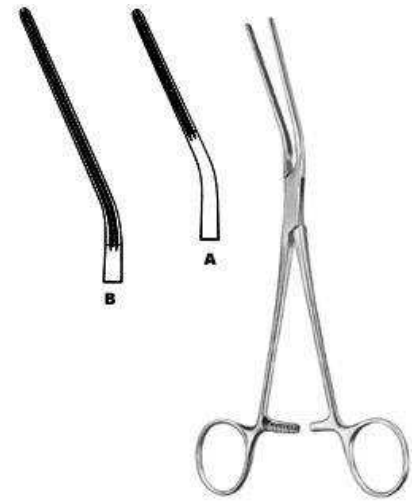

Potts
AS-9-160-21
Coarctation Clamp
20.5 cm,

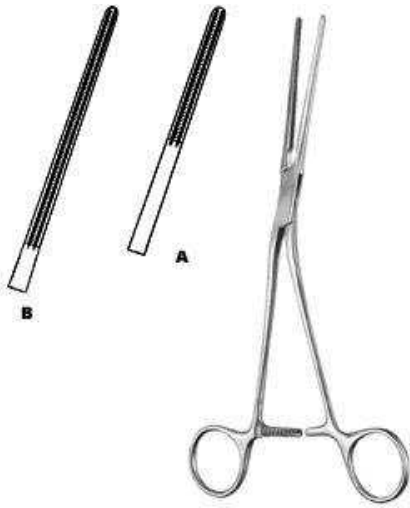

Potts
AS-9-161-21
Coarctation Clamp
20.5 cm,



Potts
AS-9-162-22
Anastomosis Clamp
21.5 cm,



Potts
AS-9-163-22
Anastomosis Clamp
22 cm,

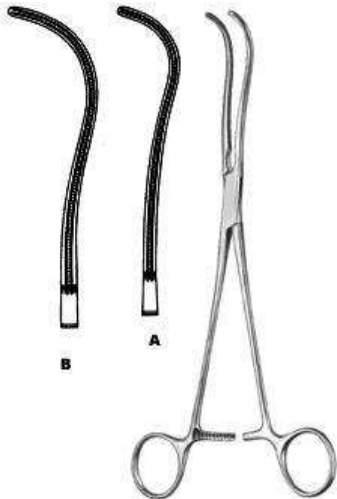

DeBakey
AS-9-164-19
Ligature Forceps
19 cm,



DeBakey
AS-9-165-16
Peripheral Vascular Clamp
16 cm,



DeBakey
AS-9-166-19
Peripheral Vascular Clamp
16 cm,

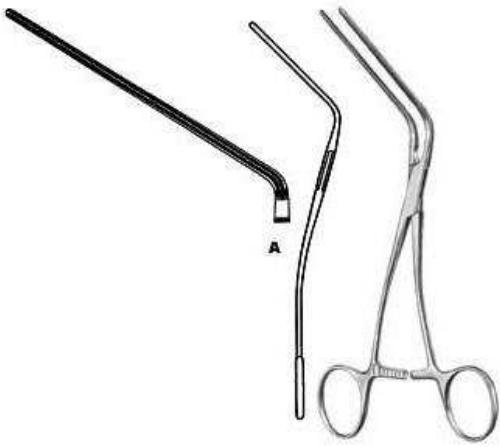

Leland-Jones
AS-9-167-18
 Peripheral Vascular Clamp
 18 cm,



Bainbridge
AS-9-168-15
 Multi purpose Vascular Clamp
 15 cm,



Bainbridge
AS-9-169-15
 Multi purpose Vascular Clamp
 15 cm,

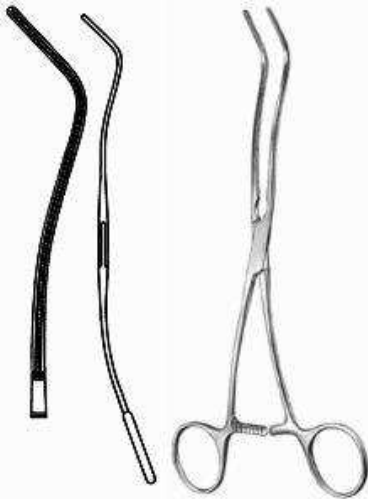

DeBakey
AS-9-170-20
 Multi purpose Vascular Clamp
 20 cm,



DeBakey
AS-9-171-26
 Aortic Aneurysm Clamp
 26 cm,



DeBakey
AS-9-172-28
 Aortic Aneurysm Clamp
 28 cm,



DeBakey
AS-9-173-30
Aortic Aneurysm Clamp
30 cm,



DeBakey
AS-9-174-27
Aortic Clamp
27 cm,



DeBakey
AS-9-175-24
Ligature Forceps
24.5 cm,



DeBakey
AS-9-176-24
Ligature Forceps
24.5 cm,



DeBakey
AS-9-178-25
Ligature Forceps
27 cm,

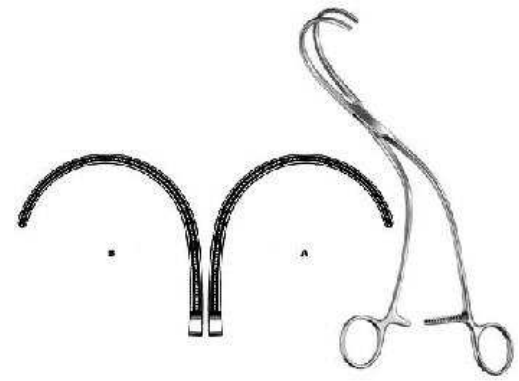

Weber
AS-9-179-01
Aortic Clamp
24 cm,



Satinsky
AS-9-180-20
Tangential Occlusion Clamp
22 cm,



Harken
AS-9-181-01
Auricle Clamp
24.5 cm,



Lees
AS-9-182-23
Bronchus Clamp
23 cm,



Lees
AS-9-183-25
Bronchus Clamp
25 cm,



Lambert-Kay
AS-9-184-21
Anastomosis Clamp
22.5 cm,



DeBakey
AS-9-185-17
Anastomosis Clamp
16.5 cm,



Morris-DeBakey
AS-9-186-18
 Aortic Clamp
 16.5 cm,



DeBakey-Bahnsen
AS-9-187-23
 Aneurysm Clamp
 23.5 cm,

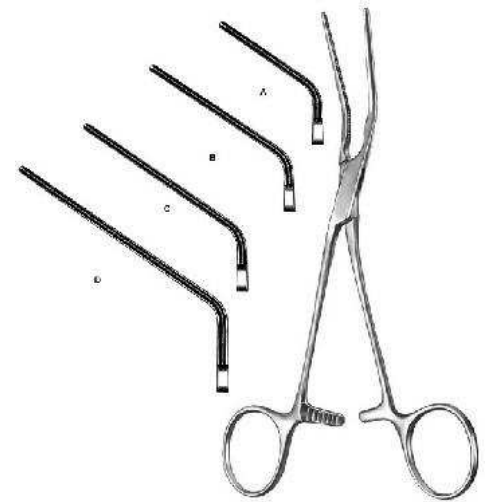

DeBakey
AS-9-188-20
 Multi purpose Vascular Clamp
 18 cm,

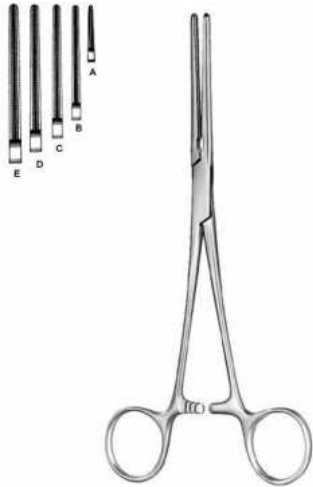

DeBakey-Mosquito
AS-9-189-12
 Haemostatic Forceps
 12.5 cm,



DeBakey-Mosquito
AS-9-190-12
 Haemostatic Forceps
 12.5 cm,



DeBakey
AS-9-191-17
 Multi purpose Vascular Clamp
 17 cm,



DeBakey
AS-9-192-16
Multi purpose Vascular Clamp
16.5 cm,

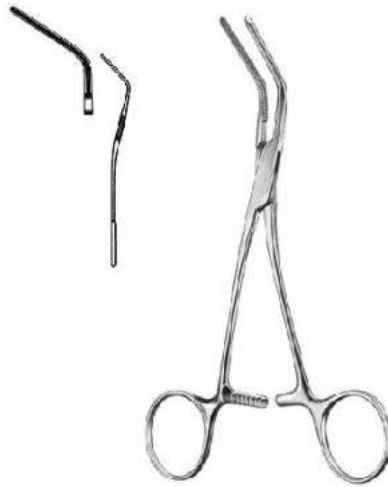

DeBakey
AS-9-193-15
Multi purpose Vascular Clamp
16 cm,



DeBakey
AS-9-194-15
Multi purpose Vascular Clamp
16.5 cm,



DeBakey
AS-9-195-17
Multi purpose Vascular Clamp
16.5 cm,



Glover
AS-9-196-17
Multi purpose Vascular Clamp
17 cm,



Glover
AS-9-197-17
Multi purpose Vascular Clamp
17.5 cm,

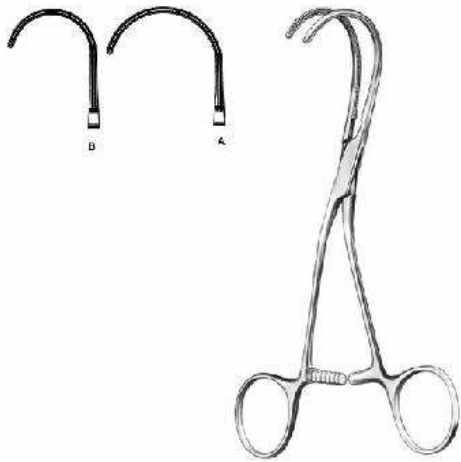

DeBailey
AS-9-198-16
 Multi purpose Vascular Clamp
 16.5 cm,

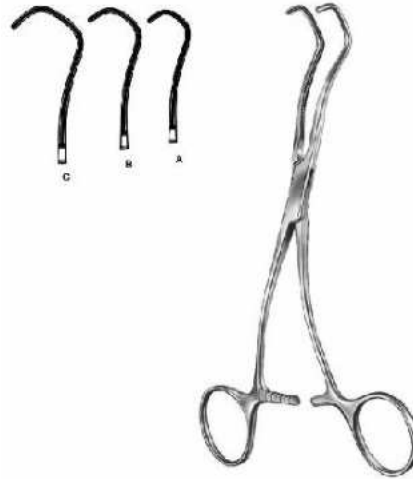

Derra
AS-9-199-16
 Anastomosis Clamp
 16.5 cm Fig. 1, 17 cm Fig. 2, 18 cm Fig. 3,



DeBailey-Beck
AS-9-200-17
 Anastomosis Clamp
 17 cm,



Cooley
AS-9-201-16
 Vascular Forceps
 16 cm,

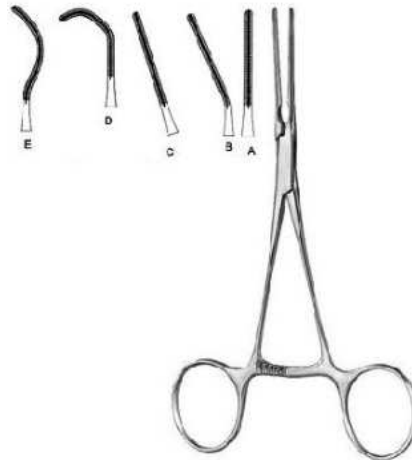

Cooley
AS-9-202-01
 Pediatric Vascular Clamp
 14.5 cm,



Cooley
AS-9-203-21
 Iliac Clamp
 22 cm,

Cardiovascular



Cooley
AS-9-204-17
Anastomosis Clamp
17 cm,

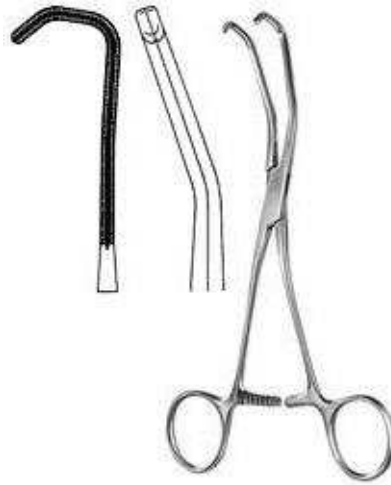

Cooley
AS-9-205-17
Anastomosis Clamp
20 cm,



Cooley
AS-9-206-16
Anastomosis Clamp
17 cm,



Cooley
AS-9-207-15
Multi purpose Vascular Clamp
16 cm,



Cooley
AS-9-208-17
Multi purpose Vascular Clamp
17 cm,



Cooley
AS-9-209-17
Multi purpose Vascular Clamp
17 cm,

Cardiovascular



Cooley
AS-9-210-17
 Multi purpose Vascular Clamp
 17.5 cm,

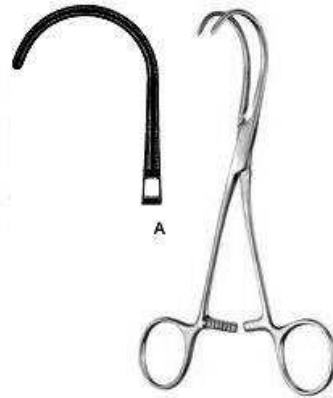

Cooley
AS-9-211-16
 Multi purpose Vascular Clamp
 16.5 cm,



Cooley-Derra
AS-9-212-16
 Anastomosis Clamp
 16.5 cm,



Cooley-Beck
AS-9-213-17
 Anastomosis Clamp
 17 cm,

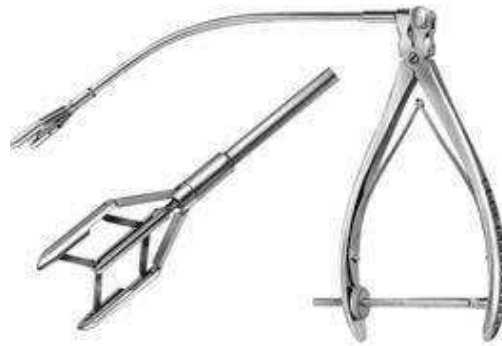

Cooley
AS-9-214-00
 Aortic Dilator



Cooley
AS-9-215-05
 Vascular Dilator
 13 cm 0,5 mm ?,



DeBakey
AS-9-216-05
 Vascular Dilator
 19 cm 0,5 mm ?,



Martin
AS-9-217-00
 Tunneling Set complete set with three shafts,
 two handles and 12 tips in storage case.



Hach
AS-9-218-01
 Fasciotomy Knife with plastic handle
 30 cm,



AS-9-219-18
 Intima Spatula
 18.5 cm,

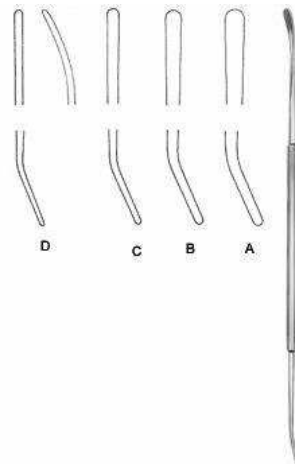

Robb
AS-9-220-01
 Vascular Dissector
 24 cm Fig. 1 2,5 mm ?, 24 cm Fig. 2 2,0 mm
 ?,



Crile
AS-9-221-20
 Nerve Hooklet
 20 cm,

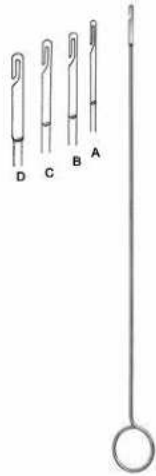

AS-9-222-15
Ligature Catcher
26 cm 1,5 mm,



Subramanian-Miniature
AS-9-223-15
Aortic Clamp 135 degree
15.5 cm,

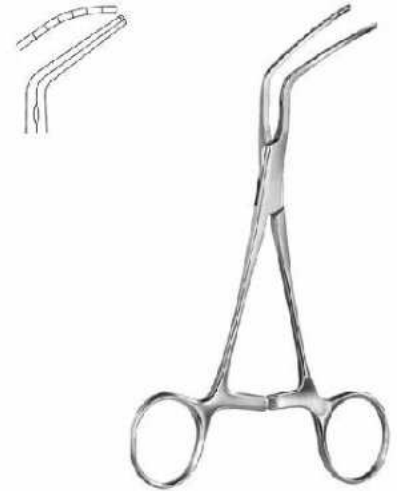

Subramanian
AS-9-224-16
Aortic Clamp
16 cm,

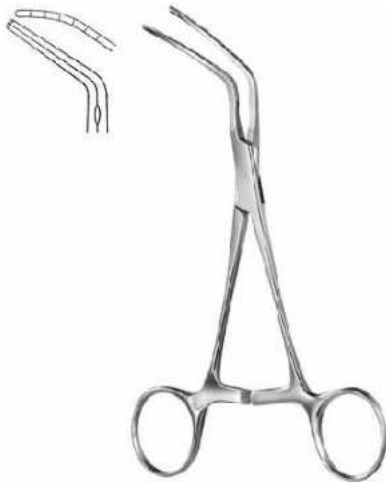

Subramanian
AS-9-225-16
Aortic Clamp
13.5 cm Fig. 1, 13.5 cm Fig. 2, 14 cm Fig. 3,

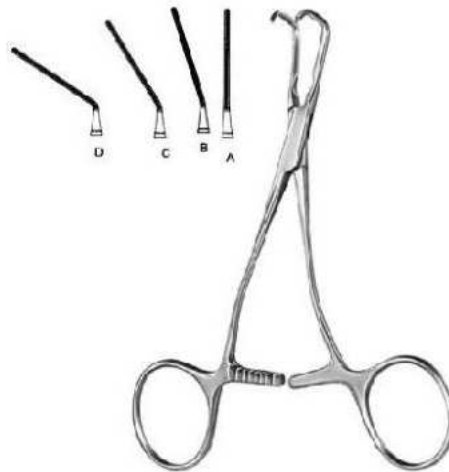

AS-9-226-01
Pediatric Vascular Clamp



AS-9-227-16
Pediatric Vascular Clamp
16.5 cm,



AS-9-228-16
Pediatric Vascular Clamp
16 cm,



Barraquer (Colibri)
AS-11-101-03
Barraquer
Size 1,



AS-11-102-07
Bowman
Size 1,

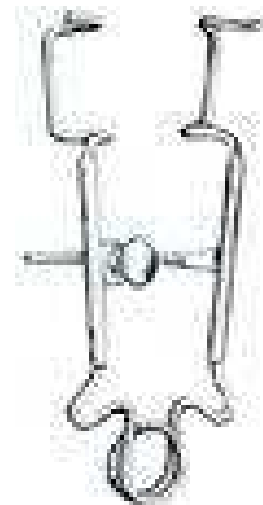

AS-11-103-06
Critchett
Size 1,



AS-11-104-05
Smith
Size 1,



AS-11-105-08
Clark
Size 1,



AS-11-106-06
Graefe
Size 1,

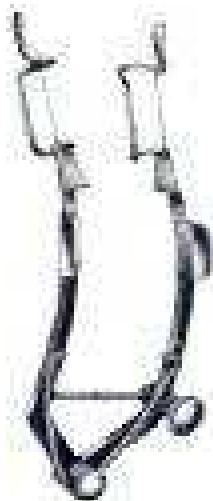

AS-11-107-08
Week
Size 1,



AS-11-108-07
Arruga
Size 1,

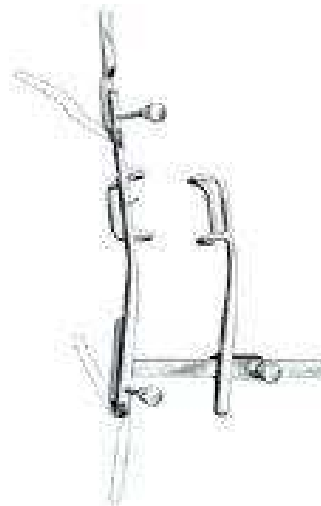

AS-11-109-07
Arruga
Size 1,

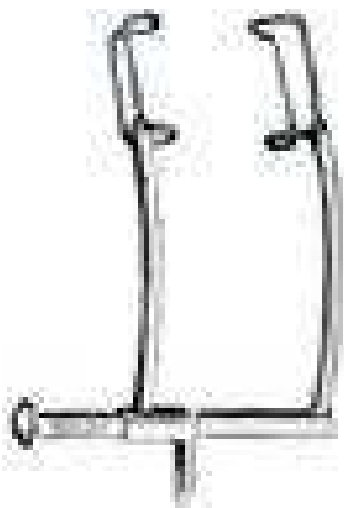

AS-11-110-05
Murdock
Size 1,

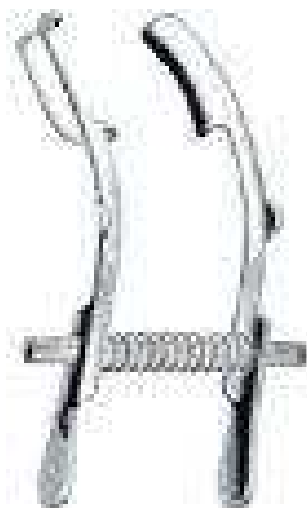

Millenger
AS-11-111-07
Mellinger Axenfeld
Size 1,



Millenger
AS-11-112-07
Mellinger Axenfeld
Size 1,

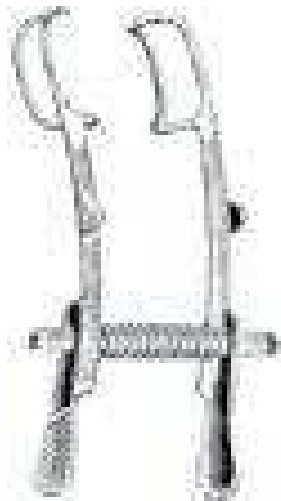

Millenger
AS-11-113-07
Mellinger
Size 1,



AS-11-114-08
Lister Burch
Size 1,



Williams Eye Speculum
AS-11-115-08
Williams
7 cm, 8.3 cm,



Lancaster
AS-11-116-07
Lancaster
Size 1,



AS-11-118-08
Ziegler
Size 1,

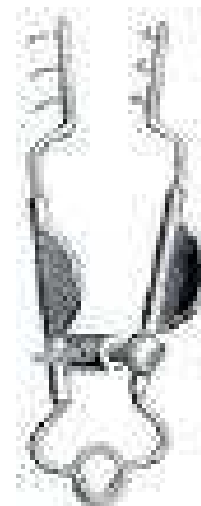

Mueller
AS-11-120-07
Mueller
Size 1,



Jaeger Lid Plate
AS-11-121-11
Jaeger
4", 20mm, 23mm,



VON GRAEFE Knife
AS-11-122-03
Graefe
1, 2, 3, 4, 5,



AS-11-123-01
Jaeger
Size 1,

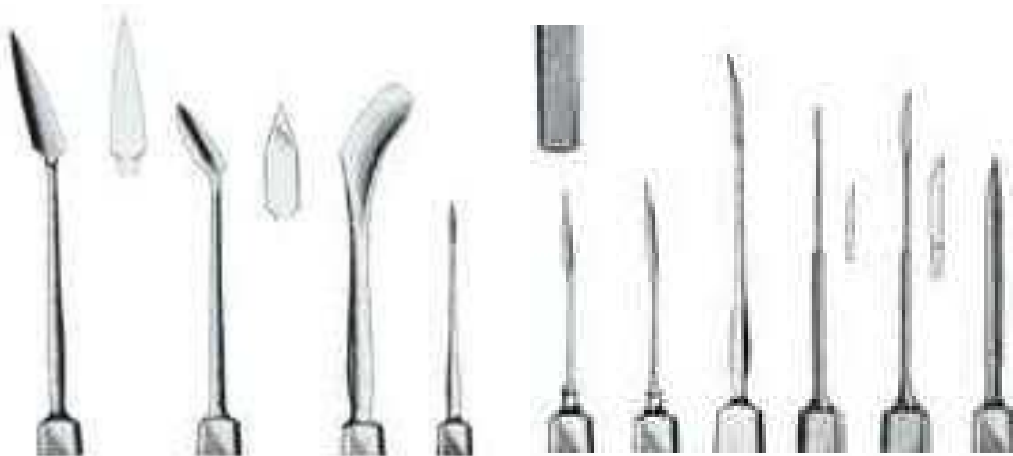

AS-11-124-13
Berens
Size 1,

ZIEGLER knife Needle
AS-11-126-01
Ziegler
11.4 cm,



Castroviejo Cyclodialysis Spatula
AS-11-127-12
Castroviejo
13.3 cm,



AS-11-128-12
Wheeler
Size 1,



Castroviejo Cyclodialysis Spatula
AS-11-129-05
Castroviejo
Size 1,



AS-11-130-12
Dix
Size 1,



AS-11-131-13
Dix
Size 1,



AS-11-132-13
Dix
Size 1,



Castroviejo Caliper
AS-11-133-07
Castroviejo
8.3 cm,



AS-11-134-13
Connin Amsler
Size 1,



AS-11-135-06
Dastoor
Size 1,



AS-11-136-09
Holth
Size 1,



Wilder Lacrimal Dilator
AS-11-137-03
Wilder
10.2 cm,



ZIEGLER Lacrimal Dilator
AS-11-138-12
Ziegler
14 cm Double End,



Castroviejo Lacrimal Dilator
AS-11-139-12
Castroviejo
14 cm,



AS-11-140-78
Bowman
Size 1,



AS-11-141-07
Graefe
Size 1,



AS-11-142-07
Graefe
Size 1,



AS-11-143-07
Graefe
Size 1,



AS-11-144-07
Graefe
Size 1,



AS-11-145-07
Fischer
Size 1,



AS-11-146-07
Barraquer Katzin
Size 1,



AS-11-147-07
Troutman
Size 1,



AS-11-148-07
Barraquer
Size 1,



AS-11-149-07
Barraquer
Size 1,



AS-11-150-09
McCullough
Size 1,



AS-11-151-09
Barraquer
Size 1,



AS-11-152-10
Jameson
Size 1,



AS-11-153-10
Jameson
Size 1,



AS-11-154-10
Bonaccolto
Size 1,



AS-11-155-10
Bonaccolto
Size 1,



AS-11-156-10
Dastoor
Size 1,



AS-11-157-10
Dastoor
Size 1,



AS-11-158-05
Bishop Harman
Size 1,



AS-11-159-08
Bishop Harman
Size 1,



AS-11-160-05
Bishop Harman
Size 1,



AS-11-161-08
Bishop Harman
Size 1,



AS-11-162-07
Mod Bonn
Size 1,



AS-11-163-07
Mod Bonn
Size 1,



AS-11-164-10
Mod Bonn
Size 1,



AS-11-165-10
Mod Bonn
Size 1,



AS-11-166-10
Mod Bonn
Size 1,



AS-11-167-10
Mod Bonn
Size 1,



AS-11-168-10
Prince
Size 1,



AS-11-169-10
Prince
Size 1,



AS-11-170-20
Berke
Size 1,



AS-11-171-08
Troutman
Size 1,



AS-11-172-05
Barraquer
Size 1,



AS-11-173-11
Elsching
Size 1,



AS-11-174-11
Graefe
Size 1,



AS-11-175-09
Lester
Size 1,



AS-11-176-09
Castroviejo
Size 1,



AS-11-178-09
Castroviejo
Size 1,



AS-11-179-09
Barraquer
Size 1,



AS-11-180-10
Green
Size 1,



AS-11-181-07
Gill Arruga
Size 1,



AS-11-182-01
Castroviejo
Size 1,



AS-11-183-05
Castroviejo
Size 1,



AS-11-184-10
Moorfield
Size 1,



AS-11-185-07
St Martin
Size 1,



AS-11-186-10
Mod Tubingen
Size 1,



AS-11-187-10
McPherson
Size 1,



AS-11-188-10
McPherson
Size 1,



AS-11-189-09
Ayer
Size 1,



AS-11-190-09
Ayer
Size 1,



AS-11-191-09
Desmarres
Size 1,



AS-11-192-10
Snellen
Size 1,



AS-11-1193-11
Knapp Luer
Size 1,

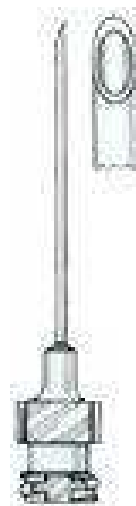

AS-11-194-28
Scheie
Size 1,



AS-11-195-45
Mod Tubingen
Size 1,



AS-11-196-00
Elliot
Size 1,

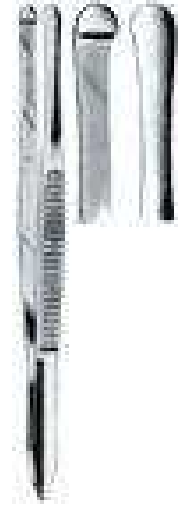

AS-11-197-09
Beer
Size 1,

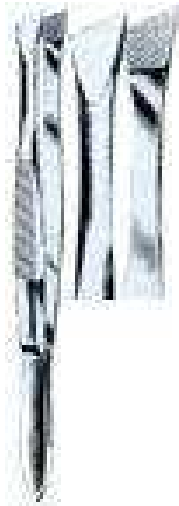

AS-11-198-10
Barraquer



AS-11-199-09
Douglas
Size 1,



AS-11-200-09
Gradle
Size 1,



AS-11-177-09
Castroviejo
Size 1,

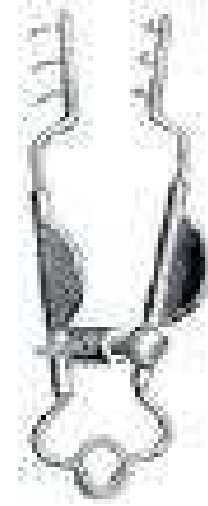

AS-11-119-07
Mueller
Size 1,

Tracheotomy

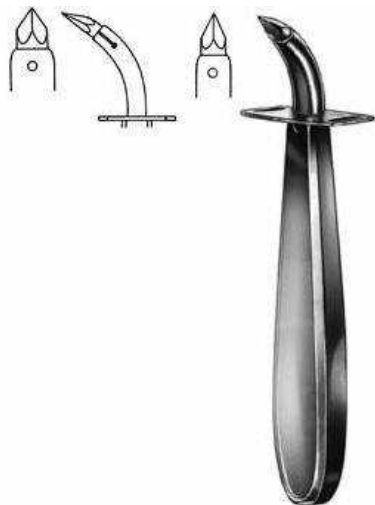

Ueckermann
AS-16-101-13
 Tracheotomy Trocar
 11.5 cm,



Iterson
AS-16-102-16
 Tracheal Hook
 17 cm,



Rose
AS-16-103-13
 Tracheal Hook
 13.5 cm,



Luer
AS-16-104-11
 Tracheal Hook
 11 cm,



AS-16-105-15
 Tracheal Hook
 15 cm,



Lukens
AS-16-106-17
 Thymus Retractor
 17.5 cm,

Tracheotomy



Jackson
AS-16-107-17
Tracheal Hook
18 cm,



Kocher
AS-16-108-15
Goitre Enucleator
16.5 cm,



Kocher
AS-16-109-15
Goitre Enucleator
16.5 cm,



Hofmeister
AS-16-110-21
Goitre Enucleator
20.5 cm,

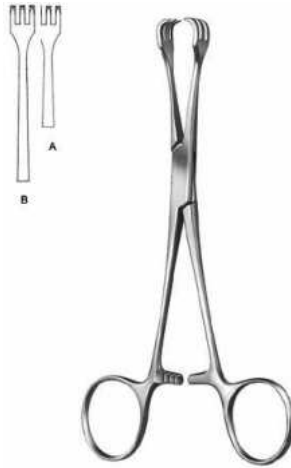

Lahey
AS-16-111-15
Goitre Grasping Forceps
15.5 cm,



Luer
AS-16-112-04
Tracheal Tube

Tracheotomy



Luer
AS-16-113-08
Tracheal Tube



Chevalier-Jackson
AS-16-114-04
Tracheal Tube outer tube closed inner tube
closed silver



AS-16-115-08
Speaking Tube



Moncorps
AS-17-101-14
Milium Knife
14 cm,



Moncorps
AS-17-102-00
Spare Blade



Vidal
AS-17-103-14
Lupus Scraper
13 cm,



Wolff
AS-17-105-01
Lupus Curette
14 cm,



Kilner
AS-17-106-15
Skin Hooklet
14.5 cm,



Gillies
AS-17-107-18
Skin Hooklet
18 cm,



Kaye
AS-17-108-03
 Face-lift Hook
 13 cm,

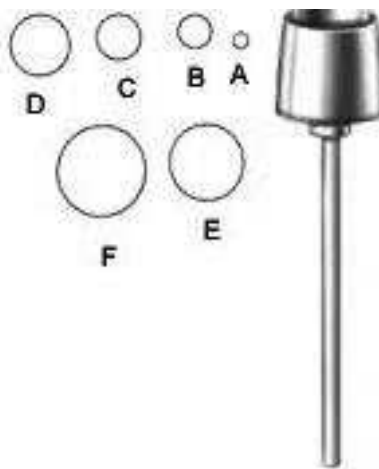

AS-17-109-02
 Dermal Punch
 5.5 cm,



Handle
AS-17-110-00
 8 cm,

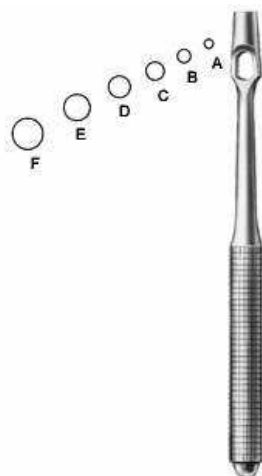

Keyes
AS-17-111-02
 Dermal Punch
 11 cm,



Unna
AS-17-113-14
 Comedone Extractor
 14.5 cm,



Saalfeld
AS-17-114-10
 Comedone Extractor
 11 cm,



Saalfeld
AS-17-115-14
Saalfeld Comedone Extractor
14.5 cm,



Schamberg
AS-17-116-10
Comedone Extractor
9.5 cm,



Katsch
AS-17-117-14
Comedone Extractor
16 cm,



Unna-Vidal
AS-17-118-11
Comedone Extractor
11.5 cm,



d'Assump?
AS-17-119-15
Face-lift Forceps
18 cm,



Gregory
AS-17-120-14
Face-lift Scissors
14 cm,

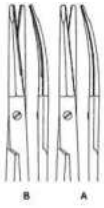

Kaye
AS-17-121-15
 Face-lift Scissors
 15 cm, 18 cm,



Stella-S
AS-17-122-18
 Face-lift Scissors
 18 cm,



Gorney
AS-17-123-18
 Face-lift Scissors
 18 cm,



Freeman-Kaye
AS-17-124-18
 Face-lift Scissors
 18 cm,



Freeman
AS-17-125-00
 Face-lift Scissors
 23 cm,



Fox
AS-17-104-01
 Lupus Curette
 14 cm,



Unna
AS-17-112-14
Comedone Extractor
14.5 cm,

Intestines & Stomach



Allis-Baby
AS-18-101-12

Intestinal and Tissue Grasping Forceps
13 cm,

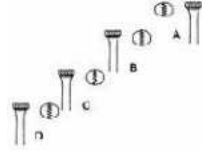

Allis
AS-18-102-15

Intestinal and Tissue Grasping Forceps
15.5 cm, 19 cm, 25.5 cm,



Allis
AS-18-103-16

Intestinal and Tissue Grasping Forceps
15.5 cm, 20 cm, 24.5 cm, 30 cm,



Allis-Adair
AS-18-104-15

Intestinal and Tissue Grasping Forceps
16 cm,



Boys-Allis
AS-18-105-15

Intestinal and Tissue Grasping Forceps
15.5 cm,



Thoms-Allis
AS-18-106-20

Intestinal and Tissue Grasping Forceps
20.5 cm,

Intestines & Stomach



Allis
AS-18-107-20

Intestinal and Tissue Grasping Forceps
20 cm,

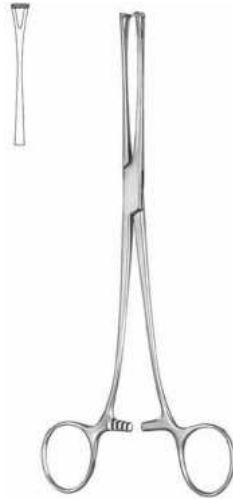

Lockwood
AS-18-108-20

Intestinal and Tissue Grasping Forceps
20 cm,



Williams
AS-18-109-16

Intestinal and Tissue Grasping Forceps
16.5 cm,

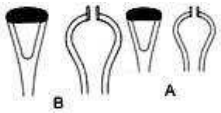

Babcock
AS-18-110-16

Intestinal and Tissue Grasping Forceps
16.5 cm, 21 cm,



Babcock
AS-18-111-16

Intestinal and Tissue Grasping Forceps
15.5 cm, 17.5 cm, 21 cm, 24 cm,

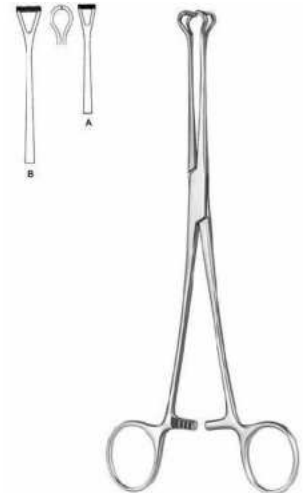

Babcock
AS-18-112-16

Intestinal and Tissue Grasping Forceps
16 cm, 20.5 cm,

Intestines & Stomach



Duval
AS-18-113-20

Intestinal and Tissue Grasping Forceps
20.5 cm,

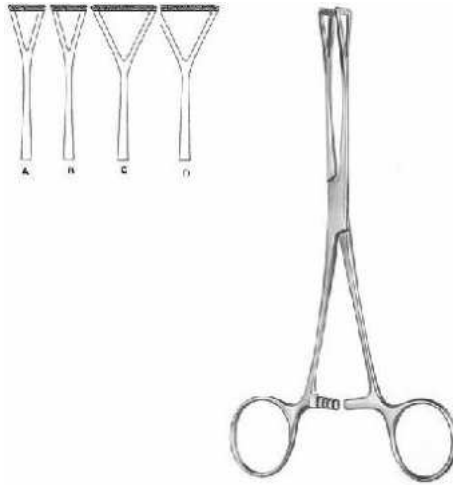

Duval
AS-18-114-18

Intestinal and Tissue Grasping Forceps
18 cm, 20.5 cm, 23 cm,

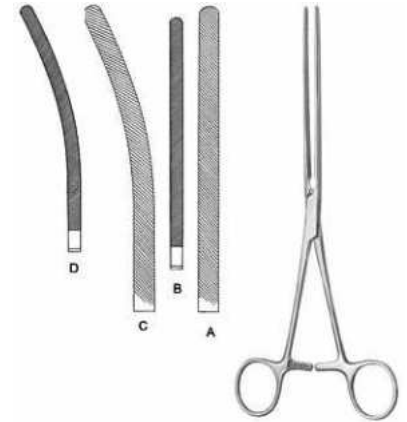

Doyen
AS-18-115-21

Intestinal Clamp
21.5 cm, 23.5 cm,



Doyen-Baby
AS-18-116-18

Intestinal Clamp
18 cm, 17.5 cm,

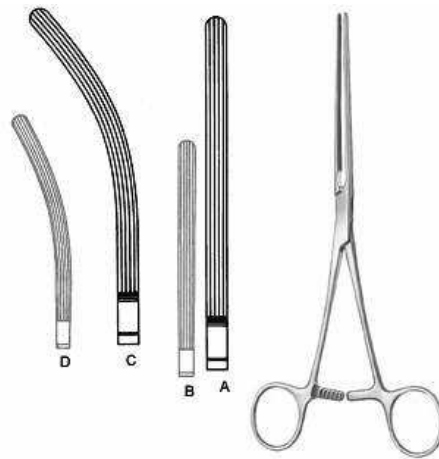

Mayo-Robson
AS-18-117-21 Intestinal
Clamp

21.5 cm, 23.5 cm, 23 cm,

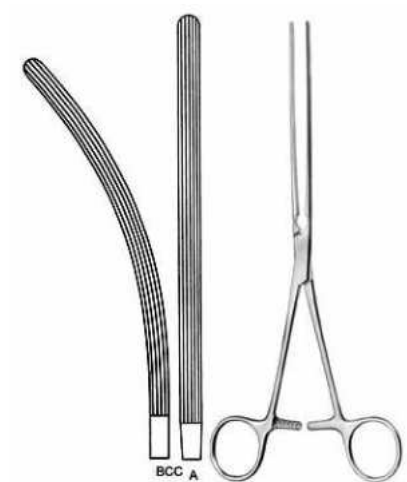

Mayo-Robson
AS-18-118-25

Intestinal Clamp
25.5 cm, 24.5 cm,

Intestines & Stomach

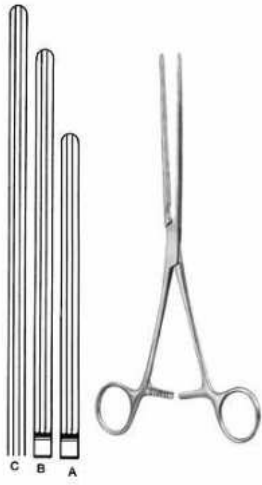

Kocher
AS-18-119-22 Intestinal
 Clamp
 22.5 cm, 25 cm, 28.5 cm,

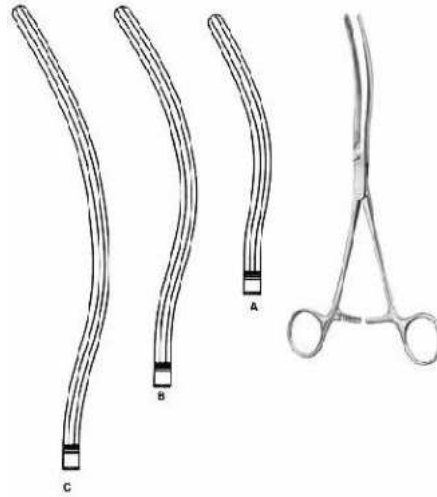

Kocher
AS-18-120-22 Intestinal
 Clamp
 22 cm, 24.5 cm, 27.5 cm,



Allen
AS-18-121-16
 Intestinal Clamp
 16 cm,



Payr-Baby
AS-18-122-15
 Intestinal and Pylorus Clamp
 15 cm,

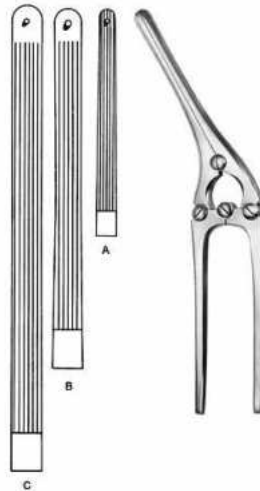

Payr
AS-18-123-21
 Intestinal and Pylorus Clamp
 20.5 cm, 29 cm, 34.5 cm,



Stone-Watt
AS-18-124-07
 Intestinal Anastomosis Clamp
 8.5 cm, 10 cm,

Intestines & Stomach



Stone-Watt
AS-18-125-15
 Closing Forceps

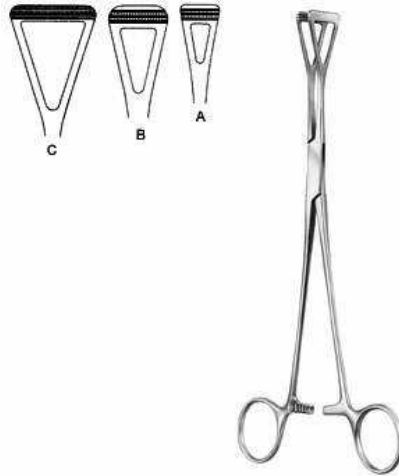

Scheibe
AS-18-126-18
 Organ Grasping Forceps
 18 cm,

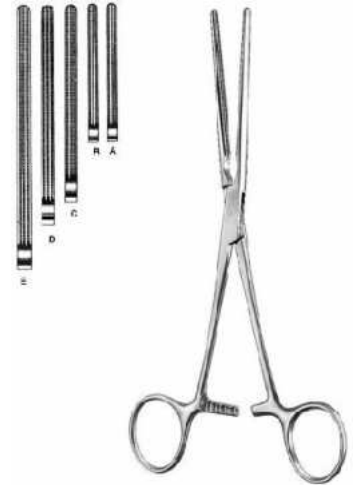

Doyen-Baby
AS-18-127-13
 Intestinal Clamp
 14 cm, 17 cm,

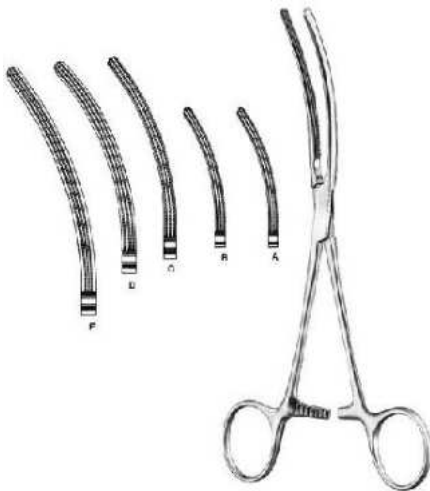

Doyen-Baby
AS-18-128-13
 Intestinal Clamp
 13.5 cm, 17 cm,



Mayo-Robson
AS-18-129-25
 Intestinal Clamp
 26 cm,



Mayo-Robson
AS-18-130-25
 Intestinal Clamp
 25 cm,

Intestines & Stomach

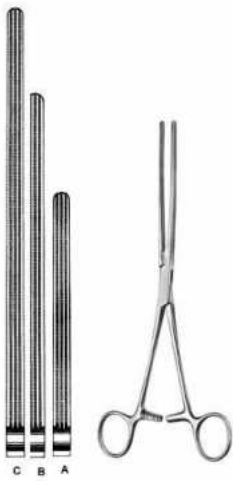

Kocher
AS-18-131-22
 Intestinal Clamp
 22.5 cm, 28 cm,

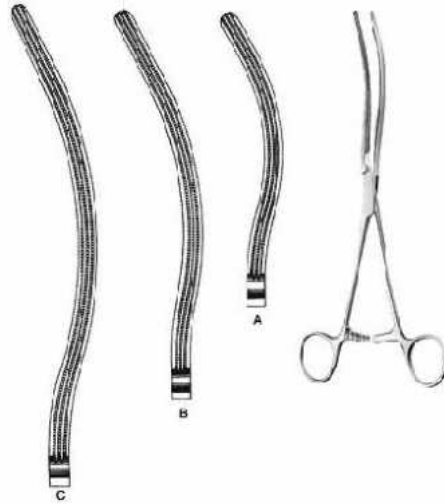

Kocher
AS-18-132-22
 Intestinal Clamp
 22 cm, 25 cm, 27.5 cm,



Scudder
AS-18-133-33
 Intestinal Clamp
 33.5 cm,

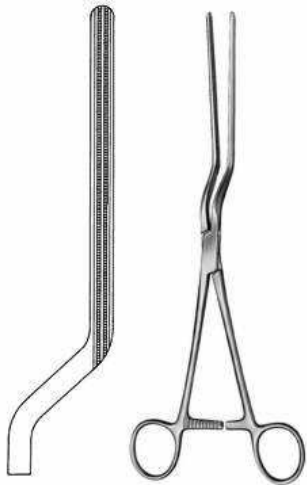

Brunner
AS-18-134-24
 Sigmoid Anastomosis Forceps
 27 cm,

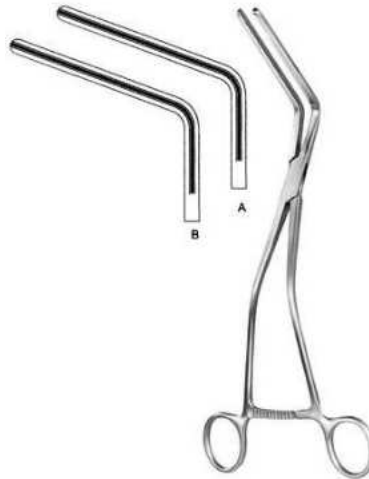

Hayes
AS-18-135-26
 Sigmoid Anastomosis Forceps
 27 cm, 28 cm,



Veidenheimer
AS-18-136-23
 Sigmoid Anastomosis Forceps
 25 cm,

Intestines & Stomach



Fehland
AS-18-137-24
Sigmoid Anastomosis Forceps
24 cm,

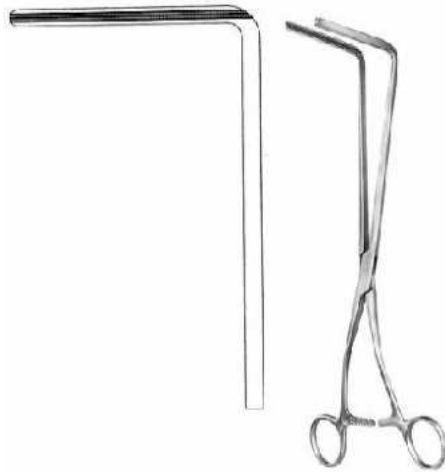

Resano
AS-18-138-30
Sigmoid Anastomosis Forceps
28 cm,



Sims
AS-18-139-15
Rectal Speculum
15.5 cm,



Sims
AS-18-140-15
Rectal Speculum
15.5 cm,



Mathieu
AS-18-141-19
Rectal Speculum
19 cm,



Alan-Parks
AS-18-142-00
Alan-Parks
14 cm,

Intestines & Stomach

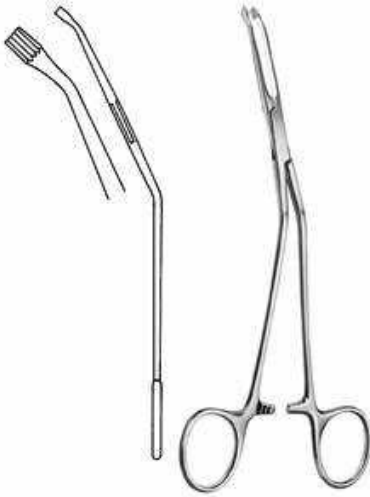

McGinvey

AS-18-143-19

Hemorrhoidal Grasping Forceps
19 cm,



AS-18-144-00

Handle for biopsy forceps



AS-18-145-38

Rectal Biopsy Forceps

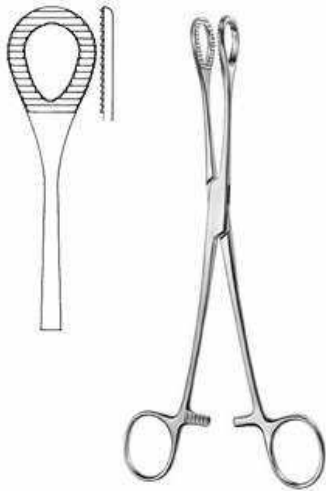

Heywood-Smith

AS-18-146-21

Polypus Grasping Forceps
21 cm,

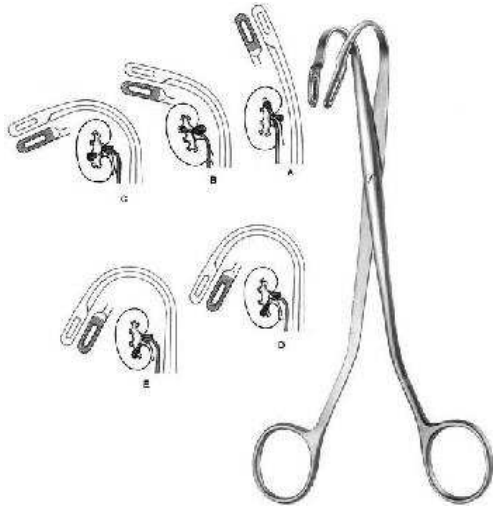

Randall
AS-19-101-23 A

Kidney Stone Forceps
23 cm Fig. 1, 21 cm Fig. 2, 19 cm Fig. 3,

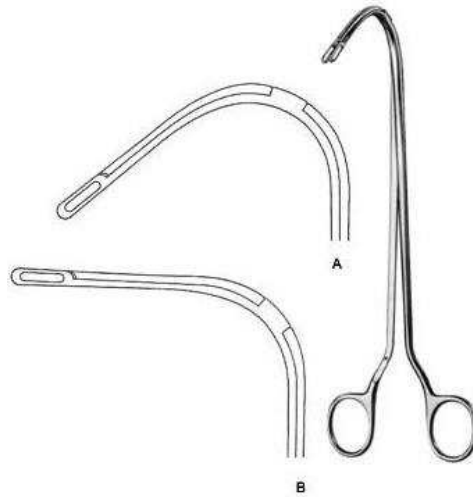

Randall
AS-19-102-23 A

Kidney Stone Forceps
23 cm, 24.5 cm,

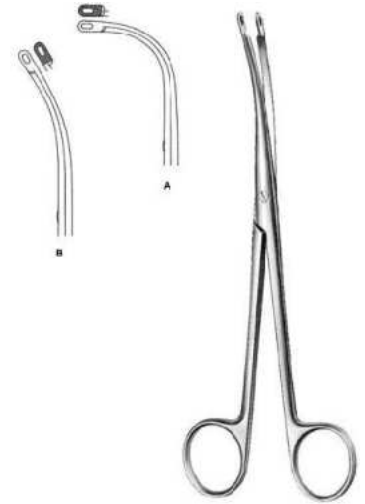

Heiming
AS-19-103-16 A

Kidney Stone Forceps
16 cm Fig. 1, 17 cm Fig. 2,

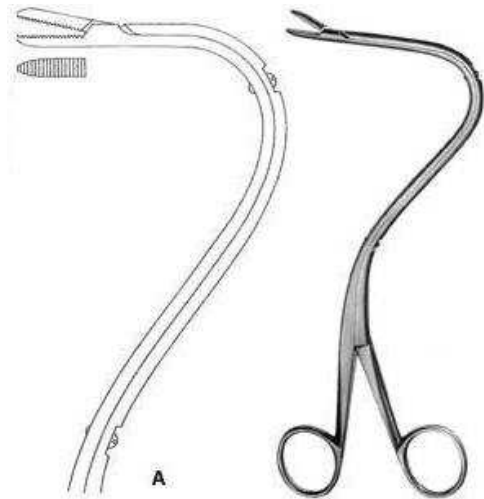

Elsasser
AS-19-104-01 A

Nephrostomy Forceps
21 cm Fig. 1, 21 cm Fig. 2,



Bakes
AS-19-105-01 A

Gall Duct Dilator
32 cm,

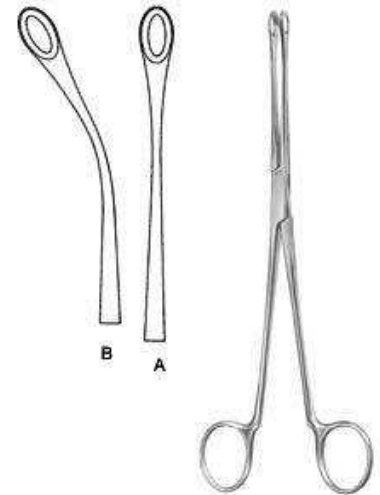

Blake
AS-19-106-20 A

Gall Stone Forceps
21 cm,



Mayo-Blake
AS-19-107-20 Gall
 Stone Forceps 21
 cm,



Mayo-Blake
AS-19-108-20 Gall
 Stone Forceps 21
 cm,



Mixer
AS-19-109-22 Gall
 Stone Forceps 21.5
 cm,



Desjardins
AS-19-110-23 A
 Gall Stone Forceps
 23 cm,

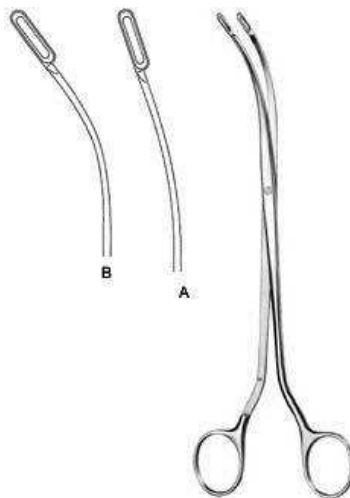

Desjardins
AS-19-111-24 A
 Gall Stone Forceps



Luer-Korte
AS-19-112-01 A
 Gall Stone Scoop
 32 cm Fig. 0, 32 cm Fig. 00, 32 cm Fig. 000, 32
 cm Fig. 1, 32 cm Fig. 2, 32 cm Fig. 3, 32 cm
 Fig. 4,

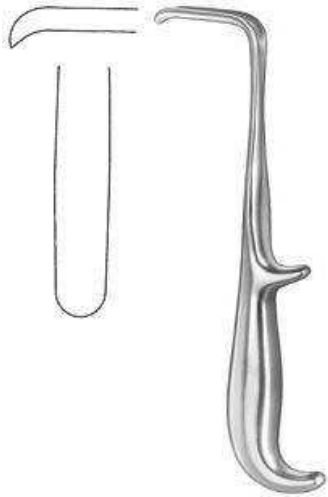

Young
AS-19-113-21
Prostatic Retractor
21.5 cm,



Young
AS-19-114-22
Prostatic Retractor
20.5 cm,



Young
AS-19-115-21
Prostatic Retractor
22 cm,

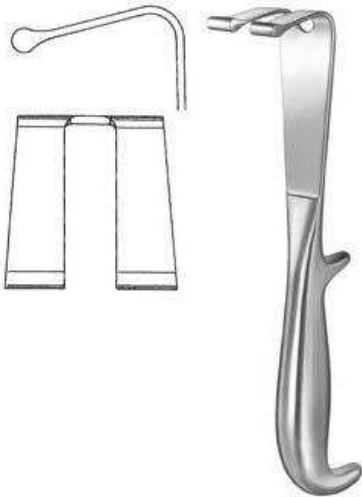

Young
AS-19-116-22
Prostatic Retractor
21.5 cm,

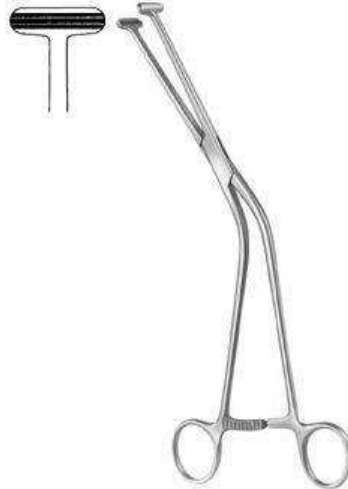

Millin
AS-19-117-24
Capsule Forceps
24.5 cm,

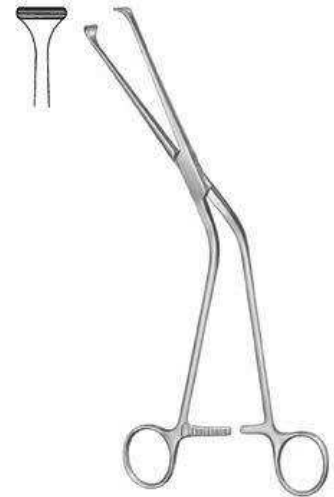

Millin
AS-19-118-24
Capsule Forceps
22 cm,

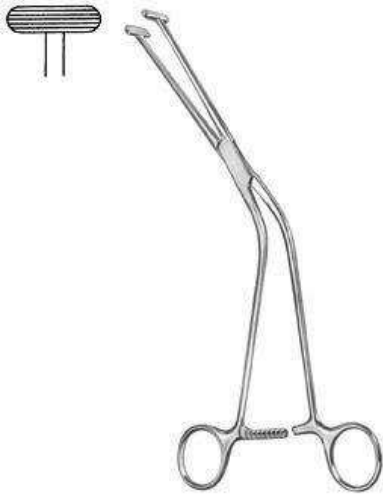

Millin
AS-19-119-23
Capsule Forceps
24.5 cm,

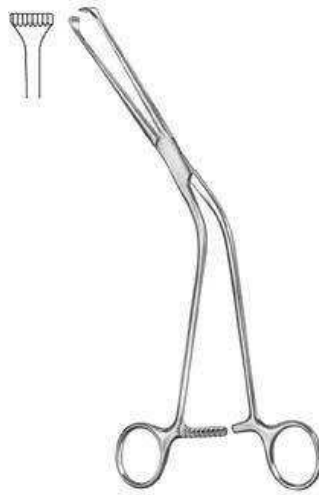

Millin
AS-19-120-23
Capsule Forceps
22 cm,

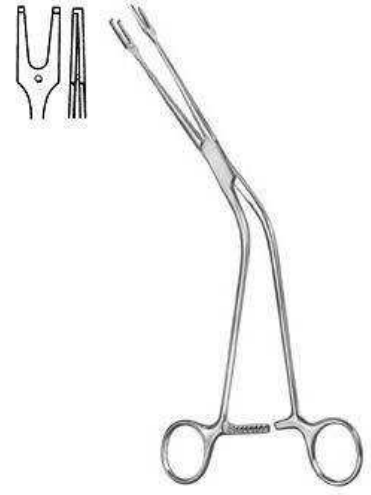

Millin
AS-19-121-24
Ligature Carrying Forceps
24.5 cm,



Millin
AS-19-122-00 Bladder
Neck Spreader 29,



Thomson-Walker
AS-19-123-00
Bladder Retractor



Judd-Masson
AS-19-124-00
Bladder Retractor



Millin
AS-19-125-00 A
 Bladder Retractor



Legueu
AS-19-126-27
 Bladder Spatula
 24 cm 35 mm,



Van Buren
AS-19-127-00
A Urethral
 Sound 27.5 cm,

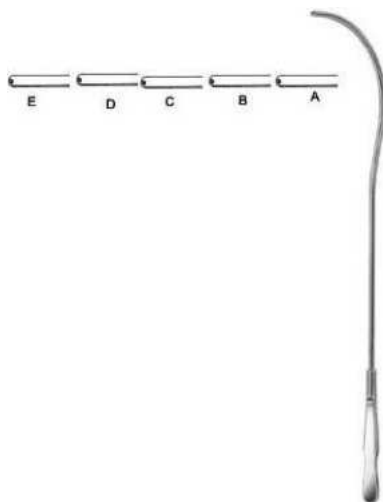

Guyon
AS-19-128-10
A Urethral
 Sound 26 cm,



Foreign body forceps
AS-19-129-11 Foreign
 body forceps 20 cm,28
 cm,



Cusco
AS-20-101
Vaginal Speculum
75 x 32 mm, 85 x 35 mm,



Cusco
AS-20-102-01
Vaginal Speculum
75 x 18 mm,



Cusco
AS-20-103-01
Vaginal Speculum
80 x 22 mm, 100 x 25 mm, 105 x 27 mm,



Cusco
AS-20-104-01
Vaginal Speculum
75 x 34 mm, 85 x 37 mm,



Collin
AS-20-105-01
Vaginal Speculum
85 x 30 mm, 100 x 35 mm,

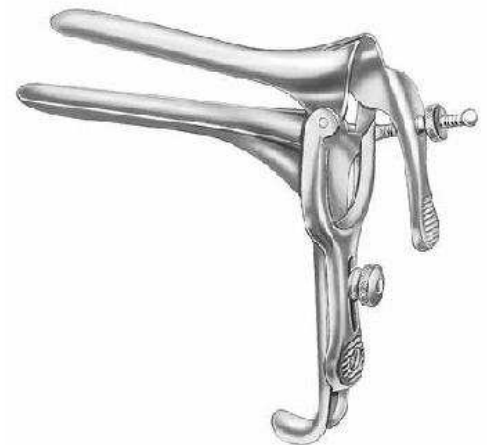

Pederson
AS-20-106-01
Vaginal Speculum
75 x 13 mm, 100 x 22 mm,



Grave
AS-20-107-01
Vaginal Speculum
75 x 20 mm, 95 x 35 mm,

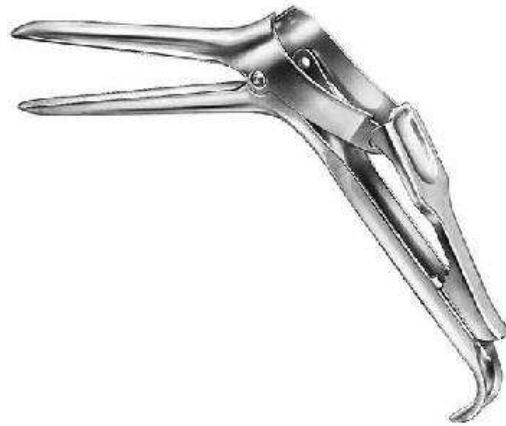

Semm
AS-20-108-01
Vaginal Speculum
100 x 20 mm, 105 x 27 mm,



Sims
AS-20-109-01
Vaginal Speculum
65 x 25 mm, 70 x 30 mm,



Kristeller
AS-20-110-01
Vaginal Speculum
70 x 27 mm,



Kristeller
AS-20-111-01
Vaginal Retractor
75 x 23 mm,



Kristeller
AS-20-112-01
Vaginal Speculum
Size 1,



Kristeller
AS-20-113-01
Vaginal Speculum
105 x 18 mm,



Kristeller
AS-20-114-01
Vaginal Retractor
110 x 14 mm,



Kristeller
AS-20-115-01
Vaginal Speculum
Size 1,

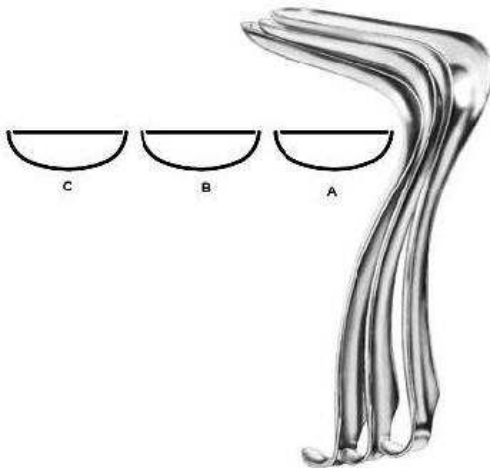

Kristeller
AS-20-116-01
Vaginal Speculum
105 x 26 mm,

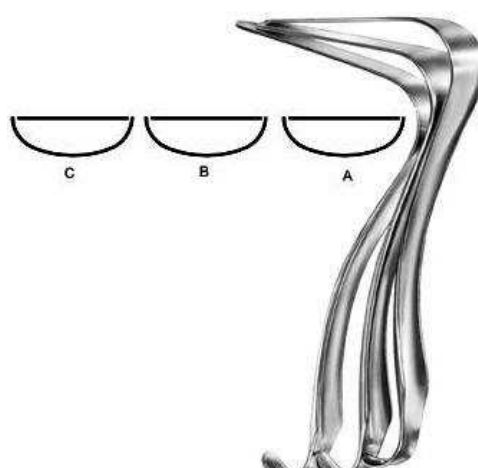

Kristeller
AS-20-117-01
Vaginal Retractor
115 x 22 mm, 115 x 24 mm,



Kristeller
AS-20-118-01
Vaginal Speculum
Size 1,

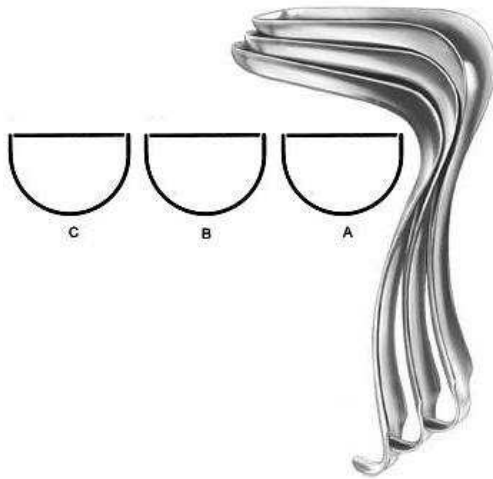

Kristeller
AS-20-119-01
Vaginal Speculum
110 x 27 mm,

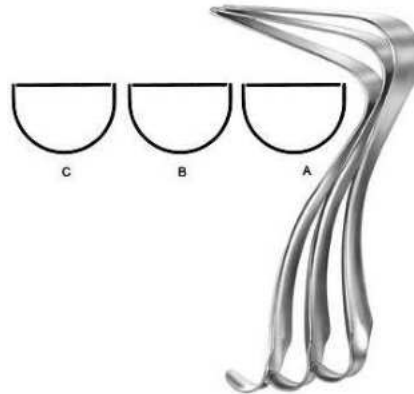

Kristeller
AS-20-120-01
Vaginal Retractor
115 x 23 mm,

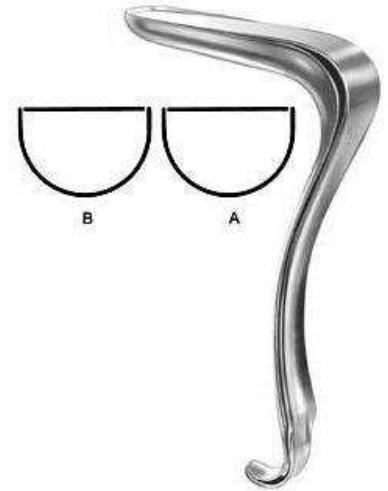

Kallmorgen
AS-20-121-01
Vaginal Speculum



Kallmorgen
AS-20-122-01
Vaginal Retractor
70 x 40 mm Fig. 1, 90 x 40 mm Fig. 2,



Kallmorgen
AS-20-123-01
Vaginal Speculum
70 x 33 mm, 90 x 33 mm,

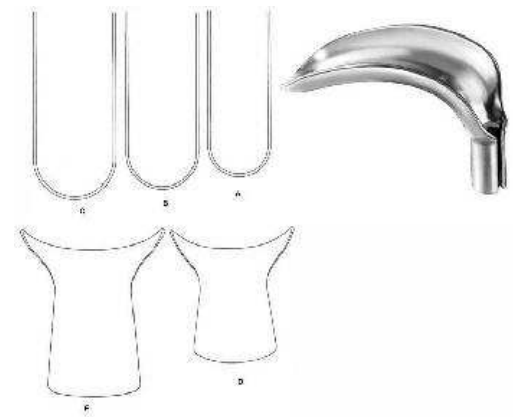

Scherbak
AS-20-125-00
Vaginal Speculum
Size 1,



Auvard
AS-20-126-22
Vaginal Speculum
80 x 43 mm,



Weissbarth
AS-20-127-24
Vaginal Speculum
21 cm 80 x 42 mm,



Breisky
AS-20-128-20
Vaginal Speculum
29 cm 100 x 20 mm, 29 cm 100 x 25 mm,



Kogan
AS-20-129-24
Endocervical Speculum
25 cm 70 x 30 mm,



Kogan
AS-20-130-24
Endocervical Speculum
24.5 cm,



Hegar
AS-20-131-24
Uterine Dilator
18.5 cm 1,0,



Hegar
AS-20-132-02
Uterine Dilator
20 cm 1,0,



Hank
AS-20-133-10
Uterine Dilator
26.5 cm Fig. 9/10,



Sims
AS-20-134-32
Uterine Sound
33 cm,



Valleix
AS-20-135-25
Uterine Sound
29.5 cm,



Braun
AS-20-136-26
Uterine Depressor
27.5 cm,



Schroder
AS-20-137-25
Uterine Tenaculum Forceps
25.5 cm,



Braun
AS-20-138-25
Uterine Tenaculum Forceps
26 cm,



Duplay
AS-20-139-28
Uterine Tenaculum Forceps
25.5 cm,



Beacham
AS-20-140-26
Amniotome
26 cm,



Skene
AS-20-141-24
Uterine Tenaculum Forceps
24 cm,

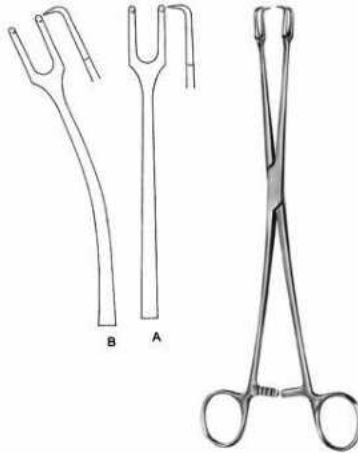

Schroder
IN-20-142-24
Uterine Tenaculum Forceps
25 cm,



Teale
AS-20-143-23
Uterine Tenaculum Forceps
23.5 cm,



Iowa
AS-20-144-26
 Uterine Tenaculum Forceps
 26 cm,

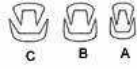

Museux
AS-20-145-24
 Uterine Tenaculum Forceps
 24 cm,



Jacobs
AS-20-146-21
 Uterine Tenaculum Forceps
 21 cm,

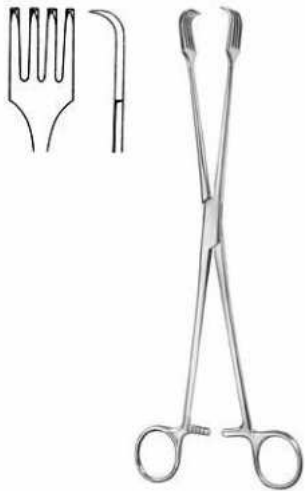

AS-20-147-26
 Uterine Tenaculum Forceps
 26.5 cm,



Braun
AS-20-148-16
 Uterine Tenaculum Forceps
 16 cm,

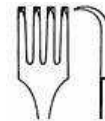

Czerny
AS-20-149-21
 Uterine Tenaculum Forceps
 21 cm,



Kelly
AS-20-150-32
Uterine Polypus Forceps
32 cm,



Noto
AS-20-151-27
Uterine Polypus Forceps
27 cm,

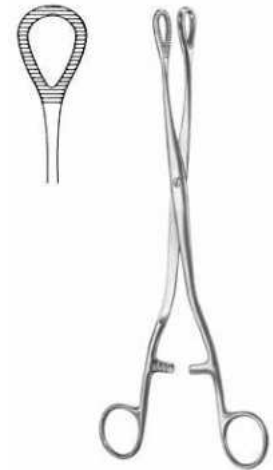

Heywood-Smith
AS-20-152-25
Uterine Polypus Forceps
25 cm,



Doyen
AS-20-153-17
Myoma Screw
17 cm,



Doyen
AS-20-154-17
Myoma Screw
14.5 cm,



Segond
AS-20-155-27
Myoma Knife
28 cm,



Dartigues

AS-20-156-27

Uterine Seizing Forceps
28 cm,

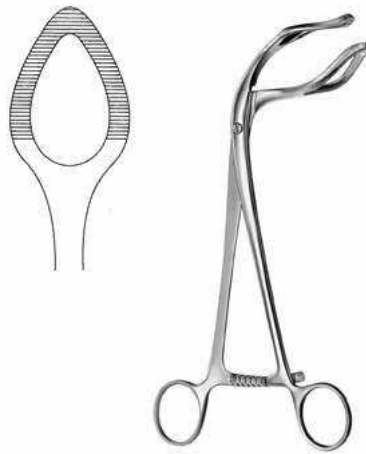

Somer

AS-20-157-27

Uterine Seizing Forceps
22.5 cm,



Collin

AS-20-158-25

Uterine Seizing Forceps jaw 40 mm wide
26 cm,



Ayre

AS-20-159-23

Conization Knife cutting edge 3,6 mm wide
23.5 cm,



Emmett

AS-20-160-03

Fistula Hook
22 cm Fig.3,



Simon

AS-20-161-22

Fistula Hook
21.5 cm,



Simon
AS-20-162-22
Fistula Hook
21.5 cm,



Novak
AS-20-163-23
Suction Curette 4 mm ?
24.5 cm,



Kevorkian
AS-20-164-23
Uterine Biopsy Curette 6,0 mm ?
30 cm,



Munchen
AS-20-165-27
Uterine Biopsy Curette 4,8 mm ?
27 cm,



Gellhorn
AS-20-166-23
Uterine Biopsy Forceps jaw 8,6 mm wide
24 cm,



Faure
AS-20-167-21
Faure Uterine Biopsy Forceps
21 cm,



Schubert
AS-20-168-21

Uterine Biopsy Forceps jaw 4,8 mm wide
21.5 cm, 28 cm,

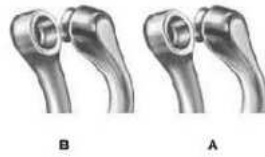

Thoms-Gaylor
AS-20-169-22

Uterine Biopsy Forceps jaw 5,6 mm ?
21 cm, 23.5 cm,

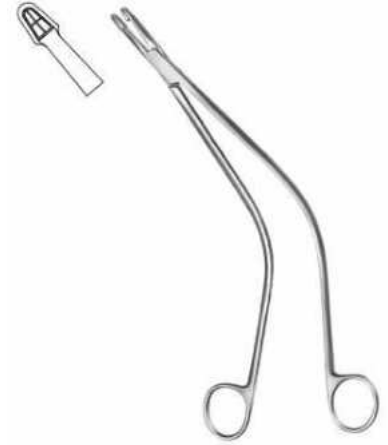

Schubert
AS-20-170-26

Schubert Uterine Biopsy Forceps
25.5 cm,

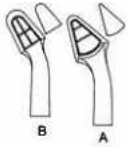

Van Doren
AS-20-171-24

Uterine Biopsy Forceps jaw 4,9 mm wide
27 cm, 25.5 cm,



Alexander
AS-20-172-28

Uterine Biopsy Forceps jaw 5,1 mm wide
28 cm,



Kevorkian
AS-20-173-32

Uterine Biopsy Forceps
25 cm,

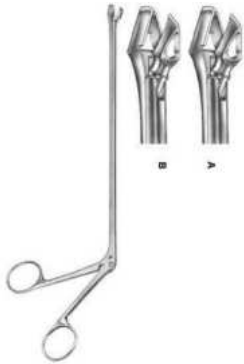

Schumacher
AS-20-174-01

Uterine Biopsy Forceps jaw 4,6 / 5,4 mm wide
24 cm,



Schumacher
AS-20-175-00

Uterine Biopsy Forceps
25 cm,



AS-20-176-22

IUP Grasping Forceps 3 mm ?
22 cm,

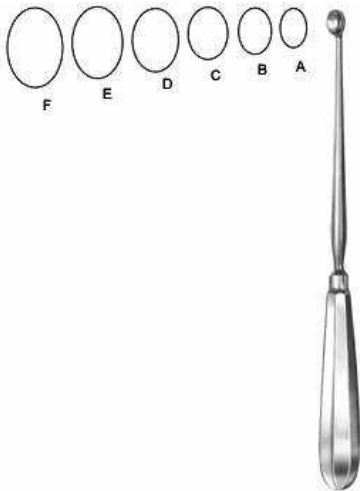

Simon
AS-20-177-01
Uterine Scoop

24.5 cm 9,8 x 8,6 mm, 24.5 cm 11,6 x 8,3 mm,



Simon
AS-20-178-01
Uterine Scoop

30 cm 9,8 x 8,6 mm, 30 cm 11,6 x 8,3 mm,



Recamier
AS-20-179-05
Uterine Curette

31 cm Fig. 00 5 mm, 31 cm Fig. 0 6 mm,



Recamier
AS-20-180-05
Uterine Curette

31 cm Fig. 00 5 mm, 31 cm Fig. 0 6 mm,



Sims
AS-20-181-05
Uterine Curette

31 cm Fig. 00 5 mm, 31 cm Fig. 0 6 mm,



Sims
AS-20-182-05
Uterine Curette

31 cm Fig. 00 5 mm, 31 cm Fig. 0 6 mm,



AS-20-183-03
Suction Curette

29 cm 3,0 mm ?, 29 cm 4,5 mm ?, 29 cm 6,0 mm ?,



Douay
AS-20-184-01
Douay

20 cm, 25 cm, 30 cm, 35 cm, 40 cm,



Thomas-Gaylor
AS-20-184-02
Thomas-Gaylor

22 cm, 24 cm,



Van Doren
AS-20-184-03
Van Doren
24 cm,



Schumacher-Van Doren
AS-20-184-04
Schumacher-Van Doren
24 cm/6mm 4mm,



Gellhorn
AS-20-184-05
Gellhorn
23 cm,



Schubert
AS-20-184-06
Schubert
21 cm, 28 cm,



Schubert
AS-20-184-07
Schubert
26 cm,



Faure
AS-20-184-08
Faure
21 cm, 24 cm,



ALEXANDER
AS-20-184-09
ALEXANDER
20 cm, 28 cm,



TISCHLER
AS-20-184-10
TISCHLER
23 cm,



TISCHLER-MINI
AS-20-184-11
TISCHLER-MINI
23 cm,



KEVORKIAN-PACIFIC
AS-20-184-12
KEVORKIAN-PACIFIC
23 cm,



TISCHLER (Baggish)
AS-20-184-13
TISCHLER (Baggish)
23 cm,



TISCHLER-BURKE
AS-20-184-14
TISCHLER-BURKE
23 cm,

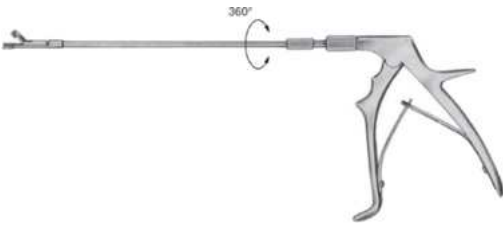

TOWNSEND
AS-20-184-15
 Handle only
 straight
 curved up
 curved down

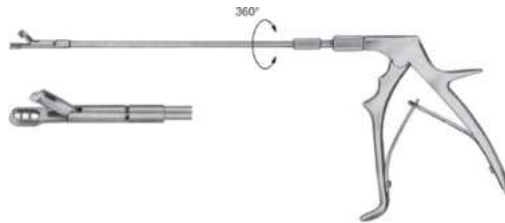

TOWNSEND-TISCHLER
AS-20-184-16
 complete
 tip only
 360°

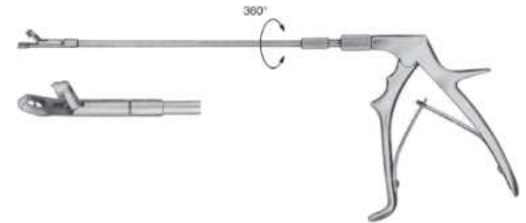

TOWNSEND-TISCHLER
AS-20-184-17
 complete
 tip only
 360°

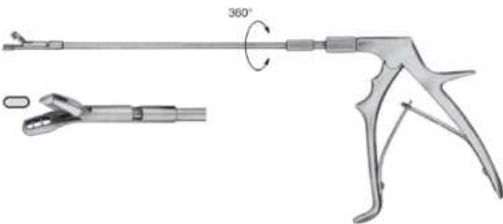

TOWNSEND-TISCHLER
AS-20-184-18
 complete
 tip only
 360°

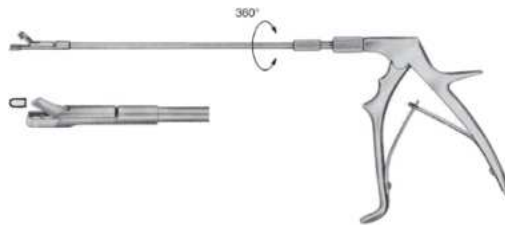

TOWNSEND-MINI
AS-20-184-19
 complete
 tip only
 360°

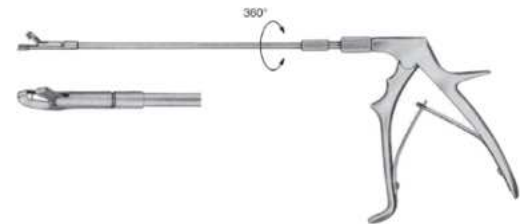

TOWNSEND-MINI
AS-20-184-20
 complete
 tip only
 360°

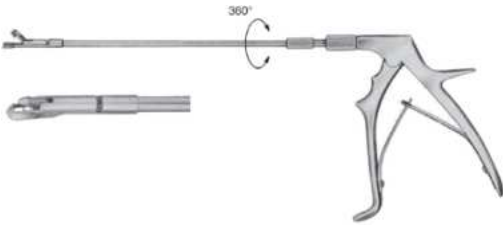

TOWNSEND-MINI
AS-20-184-21
 complete
 tip only
 360°,

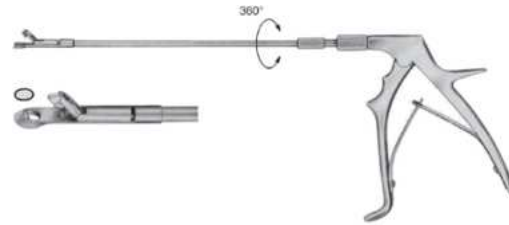

TOWNSEND-BURKE
AS-20-184-22
 complete
 tip only
 360°,

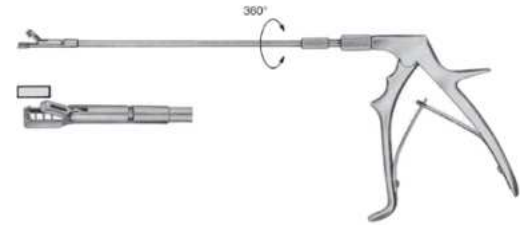

TOWNSEND-KEVORKIAN
AS-20-184-23
 complete
 tip only
 360°,

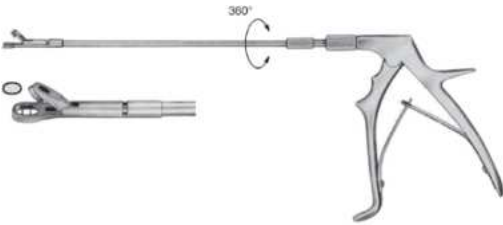

TOWNSEND-KRAUSE
AS-20-184-24
 complete
 tip only
 360°,



EPPENDORF
AS-20-184-25
 EPPENDORF
 20 cm, 23 cm,



WITTNER
AS-20-184-26
 straight
 curved
 23 cm,



SCHUMACHER
AS-20-184-27
 SCHUMACHER
 24 cm,



SCHUMACHER
AS-20-184-28
 SCHUMACHER
 24 cm,



SCHUMACHER
AS-20-184-29
 xtension canula 20 cm
 tip only
 Handle only
 24 cm #1,



KEVORKIAAN
AS-20-184-30
 KEVORKIAAN
 25 cm,



BERGER
AS-20-184-31
 BERGER
 19 cm / 3mm, 19 cm / 5mm,



Martin
AS-21-101-34 Pelvimeter
cm, inch scale 34 cm,



Nagele
AS-5-102-36
Obstetrical Forceps
35 cm, 40.5 cm,



Simpson
AS-5-103-30
Obstetrical Forceps
31 cm,



Wrigley
AS-5-104-28
Obstetrical Forceps
28 cm,



Simpson
AS-21-105-36
Obstetrical Forceps
36.5 cm,



Kielland
AS-21-106-41
Obstetrical Forceps
42 cm,

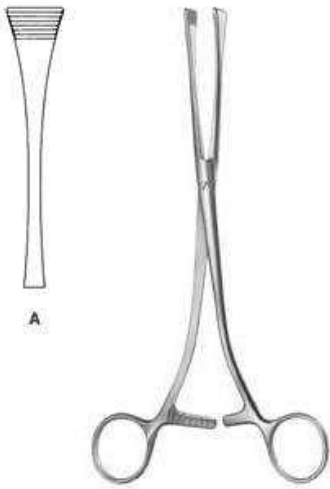

Green-Armytage
AS-21-107-21
 Uterine Clamp
 21 cm,



Sellheim
AS-21-108-28
 Obstetrical Lever
 32 cm,

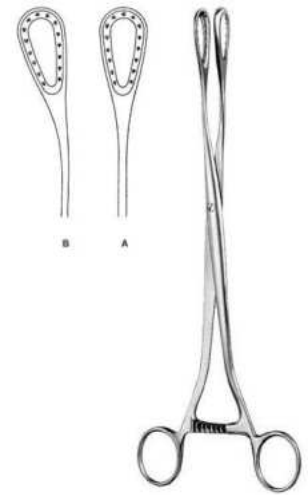

Sanger
AS-21-109-27
 Placenta and Ovum Forceps
 27.5 cm, 27 cm,

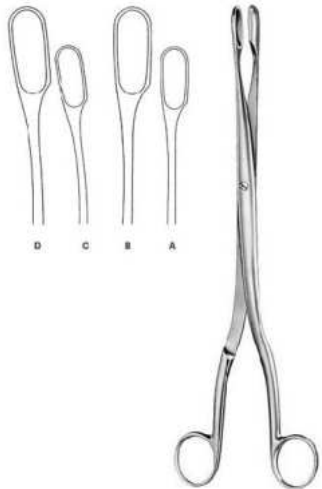

Winter
AS-21-110-01
 Placenta and Ovum Forceps
 28 cm Fig. 1, 28 cm Fig. 2,

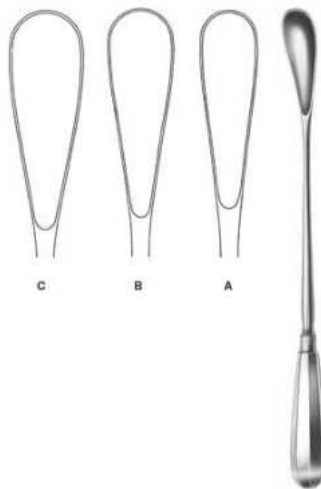

Cuzzi
AS-21-111-01
 Placenta Scoop
 30 cm 14,5 mm, 30 cm 18 mm,



Pestaloza
AS-21-112-30
 Placenta Scoop
 30 cm,

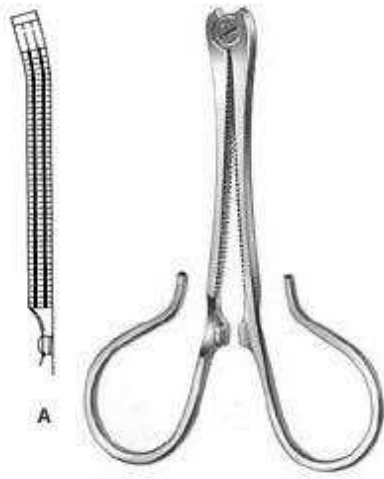

Kane
AS-21-113-08
Umbilical Cord Clamp
8.5 cm,



Collin
AS-21-114-09
Umbilical Cord Clamp
8.5 cm,



Irrigator
AS-23-101-10
Size 1,



Round Bowl
AS-23-102-16
220 mm x 70 mm, 400 mm x 150 mm,



AS-23-103-33
Round Bowl
? x h 6,00 l,



Flat Dish
AS-23-104-11
? x h 0,20 l,

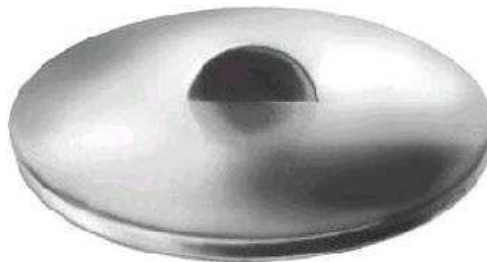

Lid only
AS-23-105-11
Size 1,



Stainless Steel
AS-23-106-04
? x h 0,30 l,



Round Dish

AS-23-107-11

? x h 0,30 l, ? 128 x 38 mm 0,40 l,



Flat Dish

AS-23-108-11

? x h 0,15 l,



Measurer

AS-23-109-01

graduated inside
100cc = 0,1 l,



Measurer

AS-23-110-02

Graduated Inside
0,25 l, 0,50 l,



Petri Dish

AS-23-111-10

with Lid ? x h



Petri Dish

AS-23-112-09

without lid ? x h
Size 1,



Lid for Petri Dishes
AS-23-113-10
Size 1,



Universal Tray
AS-23-114-23
l x b x h,



Instrument Tray
AS-23-115-21
l x b x h,



Universal Tray
AS-23-116-23
l x b x h,



Round Bowl
AS-23-117-22
? x h,



Metal Jar
AS-23-118-30
? 30mm x 90 mm, ? 50mm x 100 mm,



Instrument Box
AS-23-119-16
lid with knob
l x b x h,



Instrument Box
AS-23-120-16
lid with knob
l x b x h,



Instrument Box
AS-23-121-20
l x b x h,



Round Metal Box
AS-23-122-06
? 75 mm x 75 mm, ? 100 mm x 60 mm,



Medicine Cup Graduated Inside
AS-23-123-25
25 ccm,



Medicine Cup Graduated Inside
AS-23-124-50
50 ccm,



Tablet Tray
AS-23-125-75
? 75 mm x 12 mm,



Metal Cup
AS-23-126-90
? 90 mm x 90 mm,



Denture Cup
AS-23-127-75
? 75 mm x 50 mm,



Insert for Cup
AS-23-128-75
? 73 mm x 75 mm,



Kidney Dish
AS-23-129-17
l x b x h,



Placenta Pan
AS-23-130-36
Size 1,



Waste Cotton Collector
AS-23-131-01
? 50 mm x 75 mm,



Spirit Lamp
AS-23-132-07
120 ccm,



Charrière
AS-7-102-35
Amputation Saw
35 cm,



Langenbeck
AS-7-103-23
Amputation Saw
24.5 cm,



Charrière
AS-7-104-27
Amputation Saw
26.5 cm,



AS-7-105-14
Reamer
13.5 cm,



Perthes
AS-7-106-18
Reamer
18 cm,



Perthes
AS-7-107-21
Reamer
21.5 cm,



AS-7-108-14
Reamer
14 cm,



AS-7-111-18
Flat Trephine

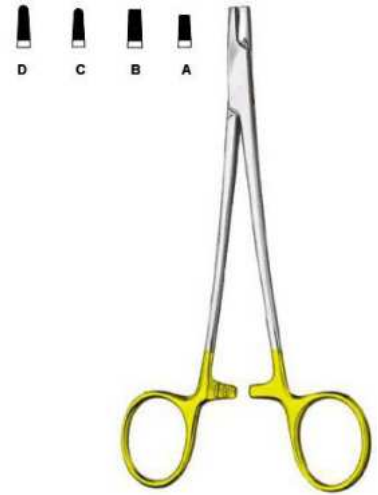

AS-7-112-01
Wire Twisting Forceps
15.5 cm, 18 cm, 20 cm,



AS-7-113-15
Wire Twisting Forceps
15.5 cm,



AS-7-114-17
Flat Nose Plier
18.5 cm,



AS-7-115-18
Wire Twisting Forceps
19 cm,



AS-7-116-15
Combi-Flat Nose Plier
15 cm,



AS-7-117-01
Flat Nose Plier
18 cm,

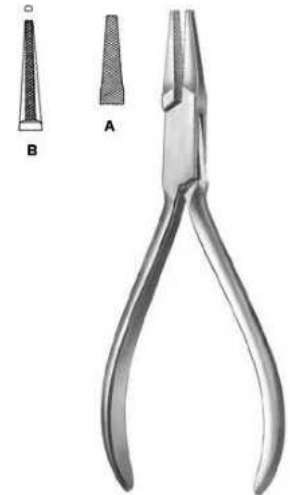

AS-7-118-14
Flat Nose Plier
13.5 cm,



Hackstock
AS-7-119-16
Flat Nose Plier
16 cm,



AS-7-120-01
Flat Nose Plier
17.5 cm,



AS-7-121-18
Wire Cutting Pliers
18.5 cm,



AS-7-122-15
Wire Cutting Pliers
15 cm,



AS-7-123-18
Wire Cutting Pliers
17.5 cm,



Demel
AS-7-124-18
Wire Guide
31 cm Fig. 1, 29 cm Fig. 2, 28 cm Fig. 3,

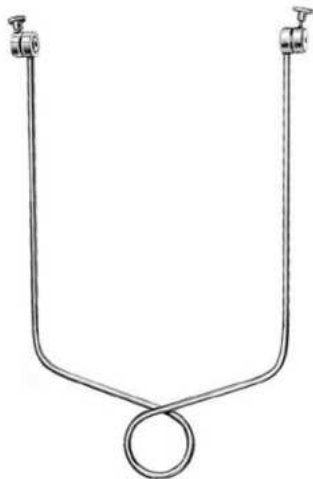

Bohler
AS-7-125-15
Extension Bow



Kirschner
AS-7-126-01
Extension Bow
18.5 cm, 26.5 cm,

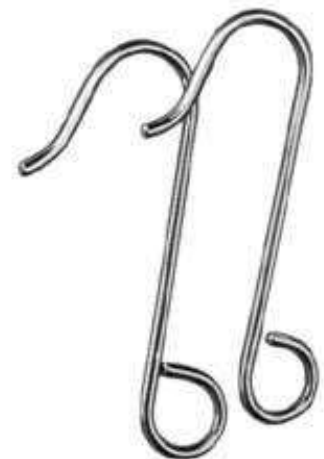

AS-7-127-06
Traction Hook for Extension Bows



Kirschner
AS-7-128-06
Wire Drill
6 cm, 12 cm,



Kirschner
AS-7-129-06
Wire Drill
14 cm, 16 cm,



Kirschner
AS-7-130-10
Wire Drill
31 cm,



Kirschner
AS-7-131-10 Wire
Drill
6 cm, 12 cm, 18 cm,



Kirschner
AS-7-132-10
Wire Drill
31 cm,



Buckley
AS-7-133-02
Chisel
16 cm,



Buckley
AS-7-134-02
 Gouge
 16 cm,



Stout
AS-7-135-03
 Bone Chisel
 21 cm,



AS-7-136-04
 Bone Chisel
 18 cm,



AS-7-137-04
 Bone Chisel
 18 cm,



AS-7-138-04
 Bone Chisel
 17 cm,



AS-7-139-04
 Bone Chisel
 17 cm,

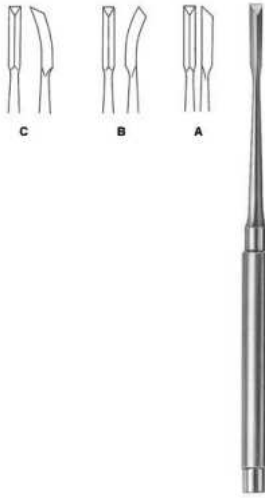

Gardner
AS-7-140-01
 Bone Chisel
 17 cm 4mm,



Snyder-O.S.U.
AS-7-141-03
 Bone Chisel
 16.5 cm 3mm, 16.5 cm 5.5mm,



O.S.U.
AS-7-142-01
 one Chisel
 17 cm 7mm,



O.S.U.
AS-7-143-01
 one Chisel
 17 cm 9mm,



AS-7-144-08
 Osteotome
 13.5 cm 8mm, 13.5 cm 10mm, 13.5 cm 12mm, 13.5 cm 14mm, 13.5 cm 16mm,



AS-7-145-08
 Chisel
 13.5 cm 8mm, 13.5 cm 10mm, 13.5 cm 12mm, 13.5 cm 14mm, 13.5 cm 16mm,



AS-7-146-08

Gouge

13.5 cm 8mm, 13.5 cm 10mm, 13.5 cm 12mm, 13.5 cm 14mm, 13.5 cm 16mm,



Partsch

AS-7-147-02

Chisel

13.5 cm 2mm, 13.5 cm 3mm, 13.5 cm 4mm, 13.5 cm 5mm, 13.5 cm 6mm, 17 cm 2mm, 17 cm 3mm, 17 cm 4mm, 17 cm 5mm, 17 cm 6mm,



Partsch

AS-7-148-02

Gouge

13.5 cm 2mm, 13.5 cm 3mm, 17 cm 2mm, 17 cm 3mm,



Stille

AS-7-149-10

Chisel

20 cm 10mm, 20 cm 15mm, 20 cm 20mm, 20 cm 25mm,



Stille

AS-7-150-10

Osteotome

20 cm 10mm, 20 cm 15mm, 20 cm 20mm, 20 cm 25mm,



Stille

AS-7-151-10

Gouges

20 cm 10mm, 20 cm 15mm, 20 cm 20mm, 20 cm 25mm,



Lambotte, Mini
AS-7-152-02

Osteotome

12.5 cm 2mm, 12.5 cm 3mm, 12.5 cm 4mm, 12.5 cm 6mm, 12.5 cm 8mm,



Lambotte
AS-7-153-15

Osteotome

24 cm 15mm, 24 cm 20mm, 24 cm 25mm, 24 cm 30mm,



Lambotte
AS-7-154-15

Osteotome

24 cm 15mm, 24 cm 20mm, 24 cm 25mm, 24 cm 30mm,



Smith-Petersen
AS-7-155-06

Osteotome

20.5 cm 6mm, 20.5 cm 9mm, 20.5 cm 13mm,



Smith-Petersen
AS-7-156-06

Osteotome

20.5 cm 6mm, 20.5 cm 9mm, 20.5 cm 13mm, 20.5 cm 16mm, 20.5 cm 19mm,



Smith-Petersen
AS-7-157-09

Gouge

20.5 cm 9mm, 20.5 cm 14mm, 20.5 cm 19mm, 20.5 cm 25mm,



Smith-Petersen
AS-7-158-09
Gouge

20.5 cm 9mm, 20.5 cm 14mm, 20.5 cm 19mm,



Hoke
AS-7-159-03
Osteotome

17 cm 3mm, 17 cm 5mm, 17 cm 6mm, 17 cm 8mm,

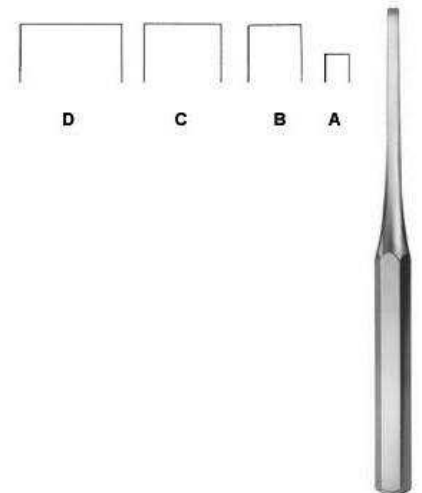

Hibbs
AS-7-160-06
Osteotome

24.5 cm 6mm, 24.5 cm 13mm, 24.5 cm 19mm,

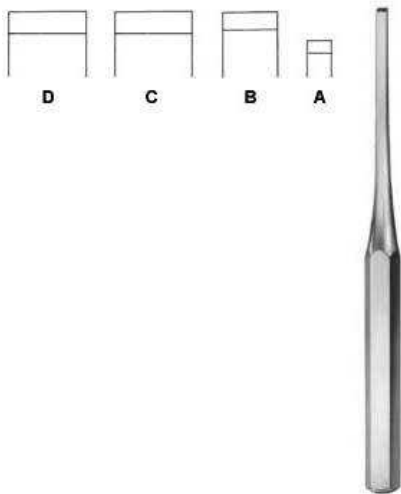

Hibbs
AS-7-161-06
Chisel

24.5 cm 6mm, 24.5 cm 19mm, 24.5 cm 13mm,

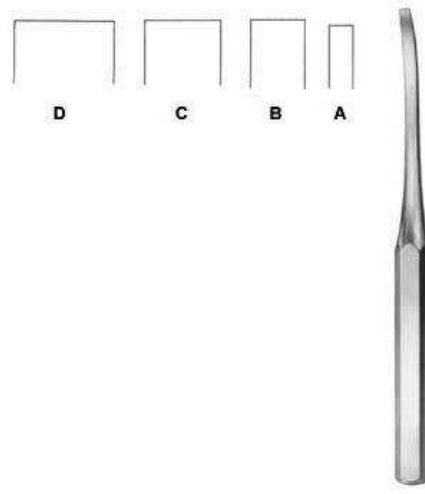

Hibbs
AS-7-162-06
Osteotome

24.5 cm 6mm, 24.5 cm 13mm, 24.5 cm 19mm,

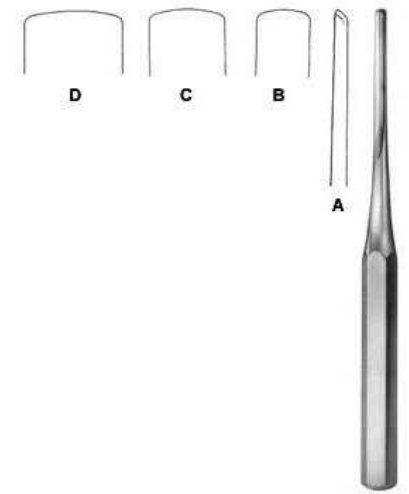

Hibbs
AS-7-163-06
Hibbs

24.5 cm 6mm, 24.5 cm 13mm, 24.5 cm 19mm,

Bone Surgery



Hibbs
AS-7-164-06
 Gouge

24.5 cm 6mm, 24.5 cm 13mm, 24.5 cm 19mm,

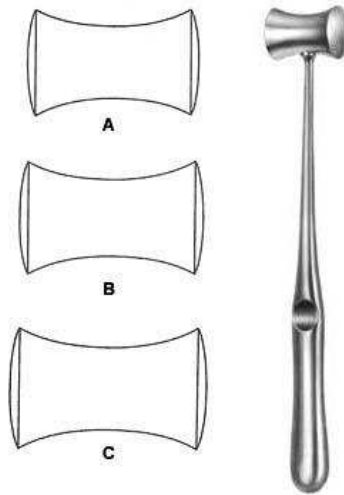

Williger
AS-7-165-01
 Mallet
 24 cm,

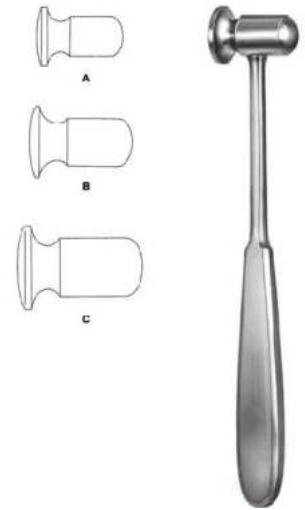

Doyen
AS-7-166-01
 Mallet
 20.5 cm, 21 cm, 21.5 cm,



Collin
AS-7-167-20
 Mallet
 20 cm,

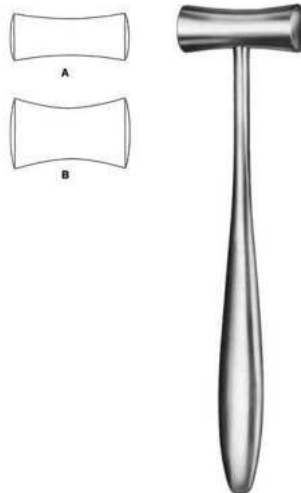

Lucae
AS-7-168-01
 Mallet
 19.5 cm,



Cottle
AS-7-169-19
 Mallet
 19 cm,



Williger
AS-7-170-01
 Mallet
 16.5 cm,



Mead
AS-7-171-17
 Mallet
 19 cm,



Partsch
AS-7-172-18
 Mallet
 19 cm,

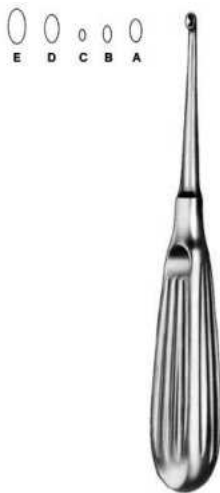

Schede
AS-7-173-01
 Bone Curette Fig. 0 to 4
 17 cm,



Volkman
AS-7-174-01
 Bone Curette
 17 cm Fig. 0, 17 cm Fig. 00, 17 cm Fig. 000, 17 cm Fig. 1, 17 cm Fig. 2, 17 cm Fig. 3, 17 cm Fig. 4,

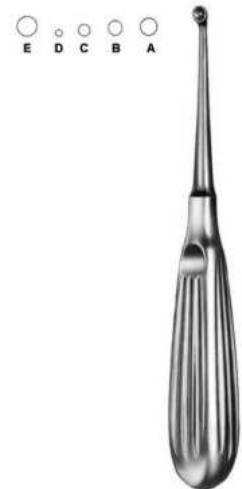

Bruns
AS-7-175-01
 Bone Curette
 17 cm Fig. 0, 17 cm Fig. 00, 17 cm Fig. 000, 17 cm Fig. 1, 17 cm Fig. 2, 17 cm Fig. 3, 17 cm Fig. 4,

o o o o
D C B A



Spratt

AS-7-176-01

Bone Curette

17 cm Fig. 0, 17 cm Fig. 00, 17 cm Fig. 000, 17 cm Fig. 0000, 17 cm Fig. 1, 17 cm Fig. 2, 17 cm Fig. 3, 17 cm Fig. 4, 17 cm Fig. 5,

o o o
C B A



Bruns

AS-7-177-01

Bone Curette

23 cm Fig. 0, 23 cm Fig. 00, 23 cm Fig. 000, 23 cm Fig. 1, 23 cm Fig. 2, 23 cm Fig. 3,

o o o
C B A



Scoville

AS-7-178-25

Bone Curette

25 cm,

o o o o o
E D C B A



Simon

AS-7-179-01

Bone Curette

25 cm Fig. 1, 25 cm Fig. 2, 25 cm Fig. 3, 25 cm Fig. 4, 25 cm Fig. 5,

o o o o o
E D C B A



Modell USA

AS-7-180-01

Bone Curette

16 cm Fig. 1, 16 cm Fig. 2, 16 cm Fig. 3, 16 cm Fig. 4,

o o o o o
E D C B A



Modell USA

AS-7-181-01

Bone Curette

15.5 cm Fig. 1, 15.5 cm Fig. 2, 15.5 cm Fig. 3, 15.5 cm Fig. 4,



Modell USA
AS-7-182-01
Bone Curette

15.5 cm Fig. 1, 15.5 cm Fig. 2, 15.5 cm Fig. 3, 15.5 cm Fig. 4,



Halle
AS-7-183-01
Bone Curette

21 cm Fig. 1, 21 cm Fig. 2, 21 cm Fig. 3,



Volkmann
AS-7-184-01
Bone Curette, double-ended
12.5 cm, 14.5 cm, 17 cm,



Volkmann
AS-7-185-13
Bone Curette, double-ended
13 cm, 16 cm,



AS-7-186-21
Bone Curette, double-ended
21 cm,



Williger
AS-7-187-00
Bone Curette, double-ended
13.5 cm Fig. 00/0, 13.5 cm Fig. 0/1, 13.5 cm Fig. 1/2,



Hemingway
AS-7-189-11
Bone Curette, double-ended
18 cm,



Hemingway
AS-7-190-00
Bone Curette, double-ended
18.5 cm,



AS-7-191-01
Bone Curette, double-ended
17.5 cm,

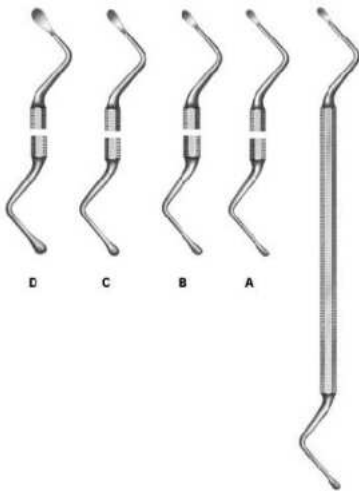

Lucas
AS-7-192-11
Bone Curette, double-ended
18 cm,

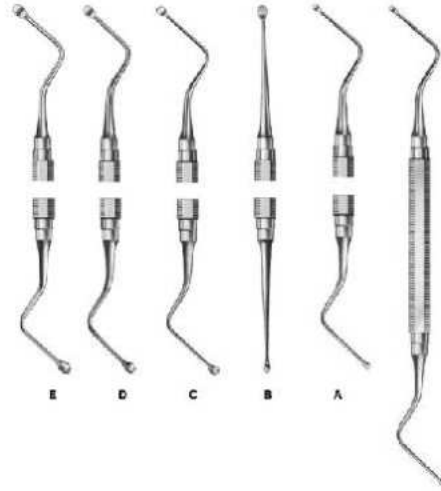

Miller-Colburn
AS-7-193-00
Bone Curette, double-ended
17 cm Fig. 0, 17 cm Fig. 1, 17 cm Fig. 2, 17 cm Fig. 3,

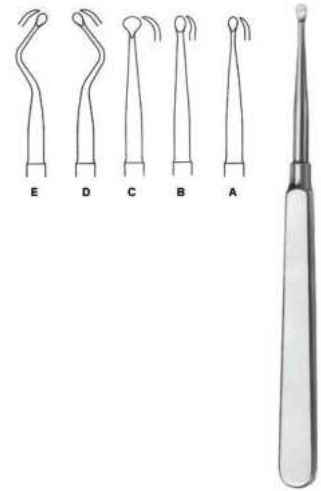

Molt
AS-7-194-01
Bone Curette
17 cm Fig. 1, 17 cm Fig. 2, 17 cm Fig. 3, 17 cm Fig. 4,

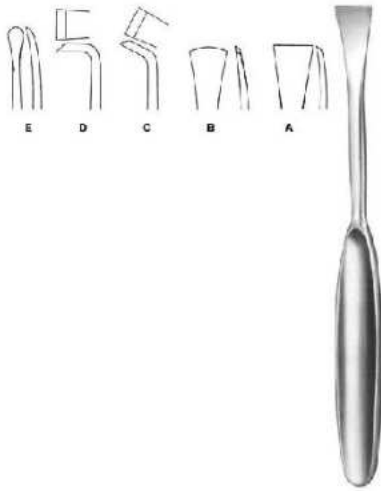

Martin-Langenbeck
AS-7-195-01
 Periosteal Elevator
 19 cm 16mm,



Langenbeck
AS-7-196-18
 Periosteal Elevator
 18.5 cm,



Langenbeck
AS-7-197-19
 Periosteal Elevator
 19.5 cm,



AS-7-198-05
 Periosteal Elevator
 16 cm 5mm, 16 cm 6mm, 16 cm 7mm,

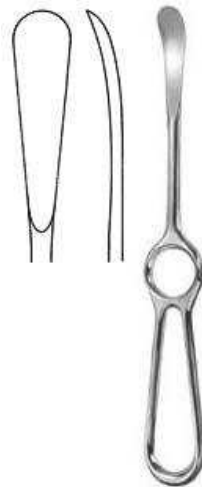

Sedillot
AS-7-199-21
 Periosteal Elevator
 22 cm 15mm,



Williger
AS-7-200-13
 Periosteal Elevator
 12.5 cm 5mm,



Kahre-Williger
AS-7-201-04
 Periosteal Elevator
 4 mm, 5 mm, 7 mm,

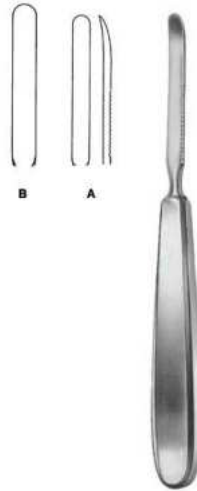

AS-7-202-06
 Periosteal Elevator
 17 cm 6 mm, 17 cm 8 mm,



Doyen
AS-7-203-17
 Rib Raspatory
 17.5 cm,

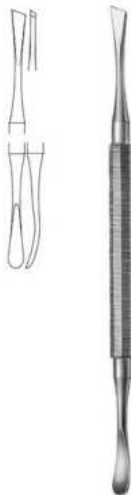

West
AS-7-204-19
 Periosteal Elevator, double-ended
 18.5 cm,



Ohl
AS-7-205-17
 Periosteal Elevator, double-ended
 17.5 cm,



Semb
AS-7-206-01
 Periosteal Elevator
 18.5 cm Fig. 1, 21.5 cm Fig. 2,



AS-7-207-22
Bone File
22 cm,

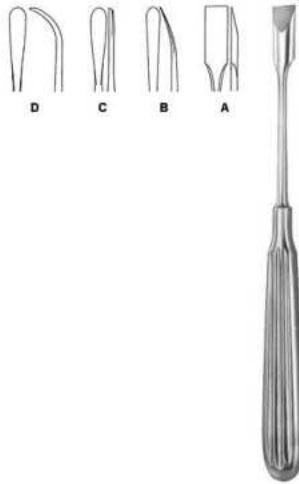

Adson
AS-7-208-17
Elevator
17 cm, 17.5 cm,

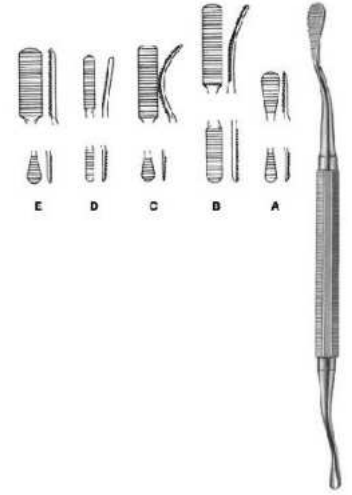

Miller-Colburn
AS-7-209-01
Bone File
18 cm Fig. 1, 18 cm Fig. 2, 18 cm Fig. 3, 18 cm Fig. 4, 18 cm Fig. 5,

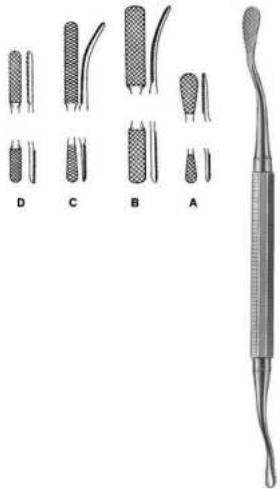

Miller-Colburn
AS-7-210-01
Bone File
18 cm Fig. 1, 18 cm Fig. 2, 18 cm Fig. 3, 18 cm Fig. 4,



Langenbeck
AS-7-211-20
Elevator
19.5 cm 8 mm, 19.5 cm 10 mm,



Martin-Langenbeck
AS-7-212-01
Elevator
17 cm 5 mm, 17 cm 7 mm, 17 cm 8 mm,



Vickers
AS-7-213-17
Elevator
17 cm,



Vickers
AS-7-214-17
Dissector
17 cm,



Williger
AS-7-215-17
Elevator
16 cm 5,5 mm,



Williger
AS-7-216-16
Elevator
16 cm 5,5 mm,



Mead
AS-7-217-17
Mallet
19 cm,



AS-7-218-18
Periosteal Elevator



Hohmann
AS-7-219-43
 Bone Lever
 23.5 cm,



Lempert
AS-7-220-19
 Bone Rongeur
 19 cm,



Luer
AS-7-221-17
 Bone Rongeur
 18.5 cm, 18 cm,



Zaufal-Jansen
AS-7-222-18
 Bone Rongeur
 18 cm,

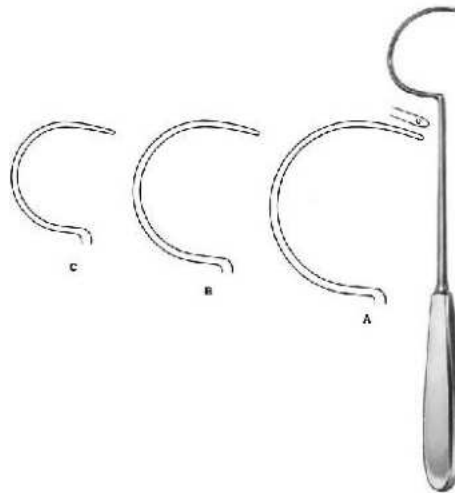

Demel
AS-7-124-01
 Wire Guide
 31 cm Fig. 1, 29 cm Fig. 2, 28 cm Fig. 3,



CARROL
AS-7-124-02
 CARROL
 11 cm,



BRAND
AS-7-124-03
BRAND



BRAND
AS-7-124-04
BRAND
15 cm,



BRAND
AS-7-124-05
BRAND
19 cm,



BRAND
AS-7-124-06
BRAND
25 cm,



KLEINERT-KUTZ
AS-7-124-07
KLEINERT-KUTZ
20 cm,



ZEMENT
AS-7-124-08
ZEMENT
25 cm / 5x10 mm,



straight
AS-20-185-01
straight



straight
AS-20-185-02
straight



straight
AS-20-185-03
straight



curved up
AS-20-185-04
curved up



curved up
AS-20-185-05
curved up



curved up
AS-20-185-06
curved up



curved to right
AS-20-185-07
curved to right



curved to right
AS-20-185-08
curved to right



curved to left
AS-20-185-09
curved to left



curved to left
AS-20-185-10
curved to left



straight
AS-20-185-11
straight

1,0 mm Ø, 1,5 mm Ø, 2,0 mm Ø, 2,5 mm Ø,



straight
AS-20-185-12
straight



curved up
AS-20-185-13
curved up

1,0 mm Ø, 1,5 mm Ø, 2,0 mm Ø, 2,5 mm Ø,



curved up
AS-20-185-14
curved up



curved to right
AS-20-185-15
curved to right

1,0 mm Ø, 1,5 mm Ø, 2,0 mm Ø, 2,5 mm Ø,



curved to right
AS-20-185-16
curved to right



curved to left
AS-20-185-17
curved to left

1,0 mm Ø, 1,5 mm Ø, 2,0 mm Ø, 2,5 mm Ø,



curved to left
AS-20-185-18
curved to left

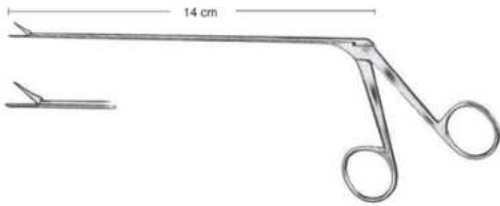

micro-scissors
AS-20-185-19
micro-scissors

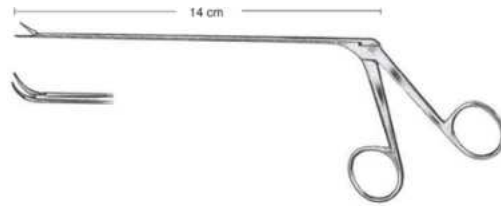

micro-scissors
AS-20-185-20
micro-scissors

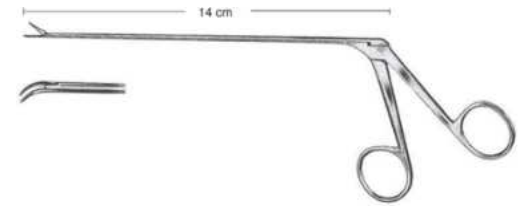

micro-scissors
AS-20-185-21
micro-scissors

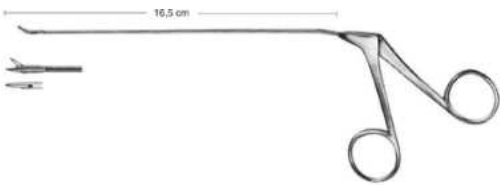

micro-scissors
AS-20-185-22
micro-scissors



micro-scissors
AS-20-185-23
micro-scissors

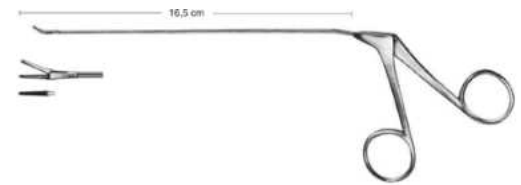

Micro forceps
AS-20-185-2
4 Micro
forceps

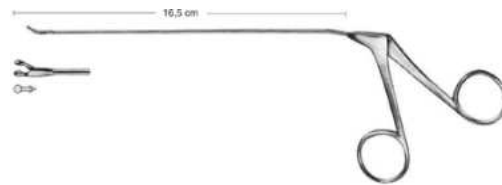

Micro forceps
AS-20-185-25
Micro forceps
2,5 mm,



LITTAUER
AS-20-186-01
LITTAUER
12 cm,



HARTMANN
AS-20-186-02
HARTMANN
12 cm,



HARTMANN
AS-20-186-03
HARTMANN
14 cm,

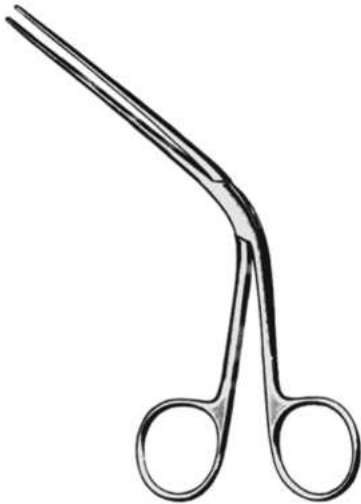

TILLEY
AS-20-186-04
TILLEY
14 cm,



QUIRE
AS-20-186-05
QUIRE
10 cm,

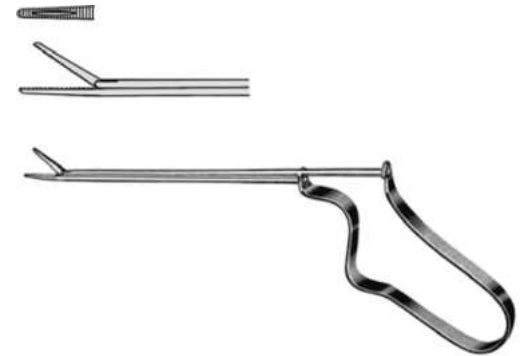

BUCK
AS-20-186-06
BUCK
11 cm,



STRUEMPEL
AS-20-186-07
STRUEMPEL



HARTMANN
AS-20-186-08
HARTMANN
8.5 cm, 14.0 cm, 16.5 cm,



HARTMANN
AS-20-186-09
HARTMANN
8.5 cm 1x2, 14.0 cm 1x2, 16.5 cm 1x2,

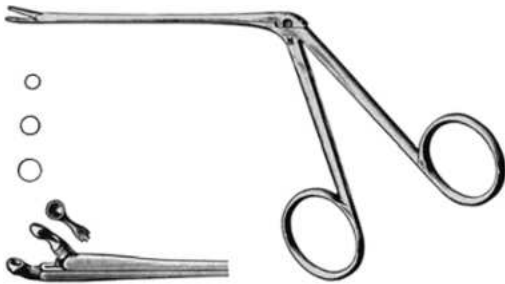

HERZFELD
AS-20-186-10
HERZFELD
8.5 cm, 2.0 mm \emptyset , 2.0 mm \emptyset , 2.5 mm \emptyset , 3.0 mm \emptyset ,

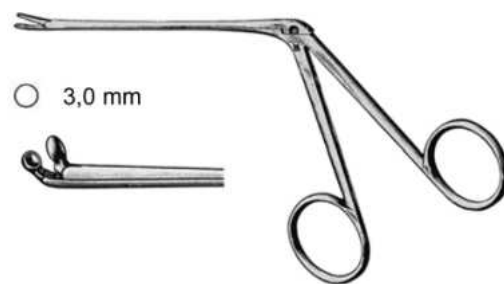

HERZFELD
AS-20-186-11
HERZFELD
8.5 , 3.0 mm \emptyset ,

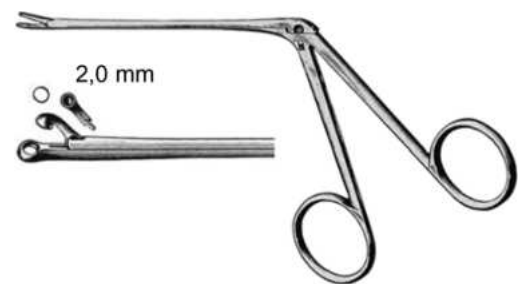

HOFFMANN
AS-20-186-12
HOFFMANN
8,5 cm, 2 mm,



HARTMANN
AS-20-186-13
HARTMANN
8.5 cm,



HARTMANN
AS-20-186-14
HARTMANN
8.5 cm,



STRUEMPEL
AS-20-186-15
STRUEMPEL
8.5 cm,

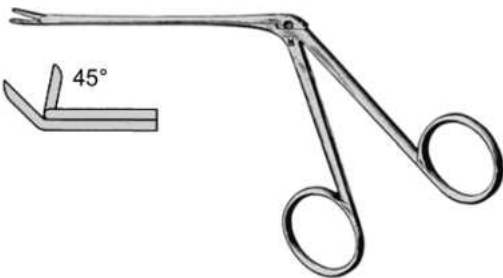

STRUEMPEL
AS-20-186-16
STRUEMPEL
8.5 , 2,5 mm,



STRUEMPEL
AS-20-186-17
STRUEMPEL
8.5 , 2,5 mm,

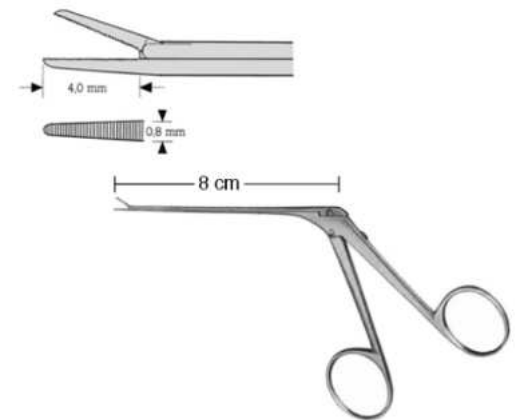

HARTMANN-MIKRO
AS-20-186-18
Curved up
Left
Right
Curved

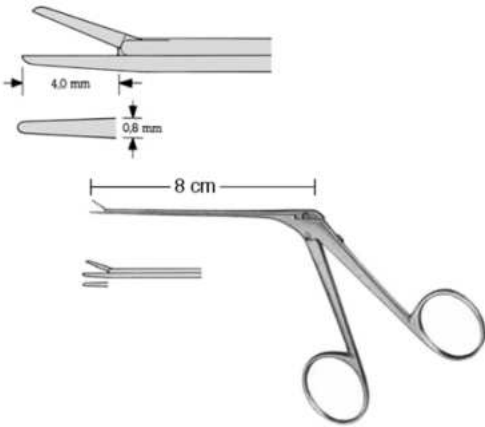

HARTMANN-MIKRO
AS-20-186-19
 glatt / smooth / lisse
 4x0,8,

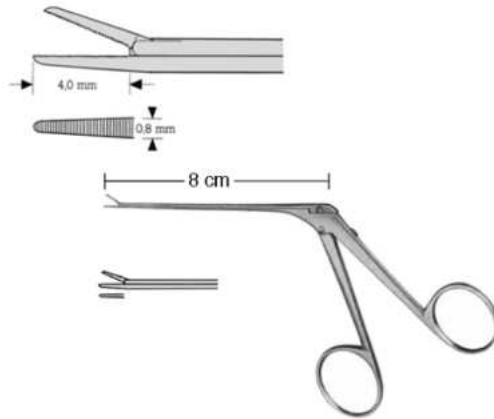

HARTMANN-MIKRO
AS-20-186-20
 gezahnt / serrated /
 4x0,8,

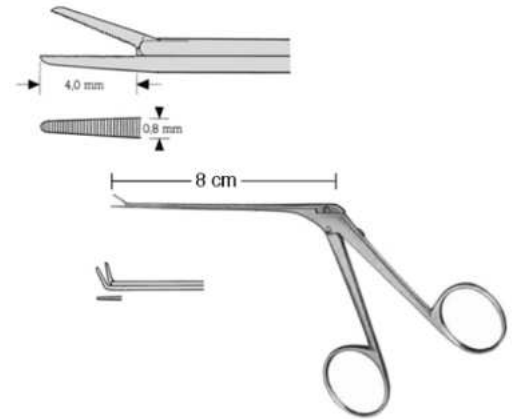

HARTMANN-MIKRO
AS-20-186-21
 aufgebogen / curved up
 4x0,8,

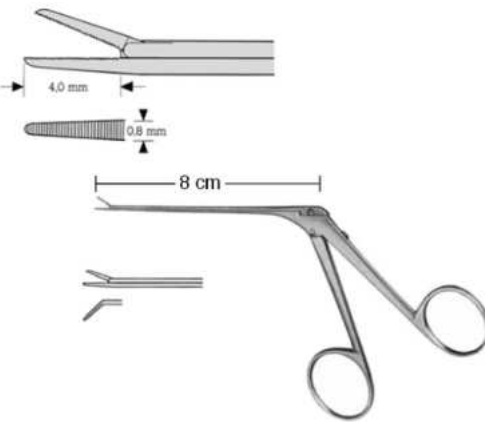

HARTMANN-MIKRO
AS-20-186-22
 links / left

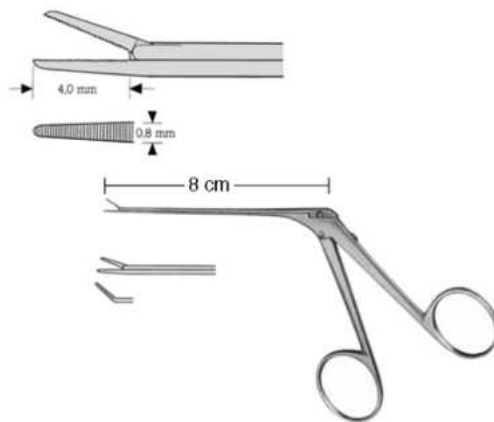

HARTMANN-MIKRO
AS-20-186-23
 rechts / right

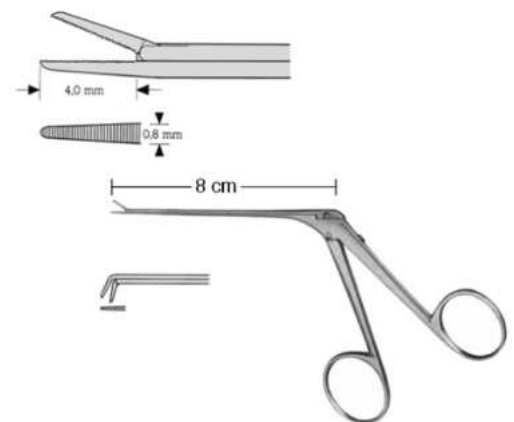

HARTMANN-MIKRO
AS-20-186-24
 curved downwards

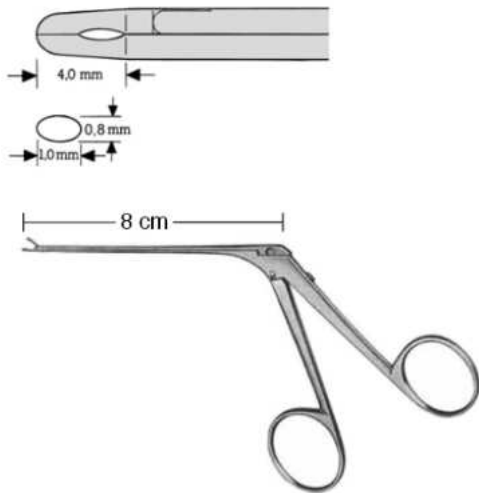

WULLSTEIN
AS-20-186-25
WULLSTEIN

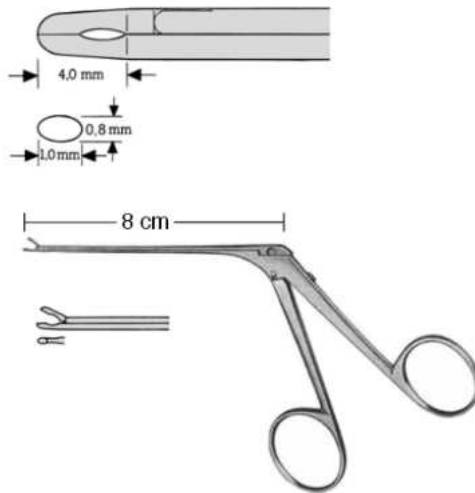

WULLSTEIN
AS-20-186-26
straight

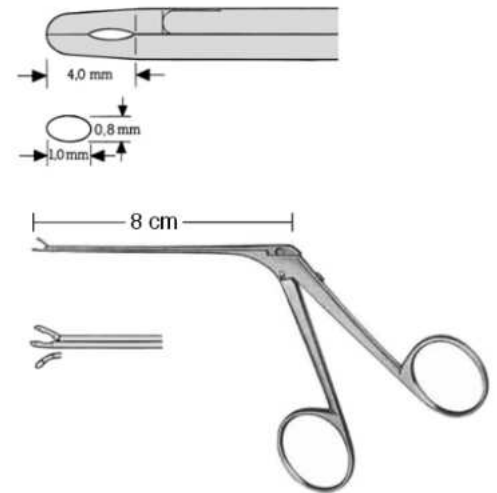

WULLSTEIN
AS-20-186-27
Left

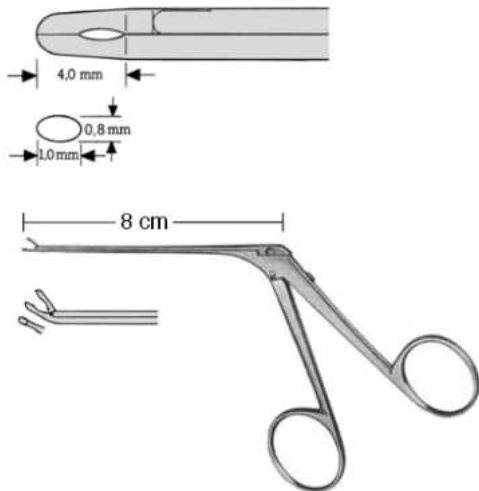

WULLSTEIN
AS-20-186-28
Curved up

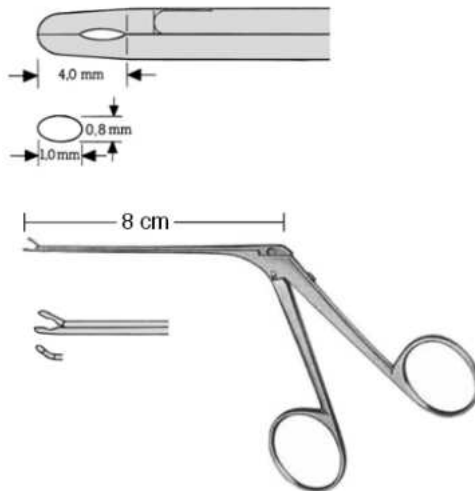

WULLSTEIN
AS-20-186-29
right

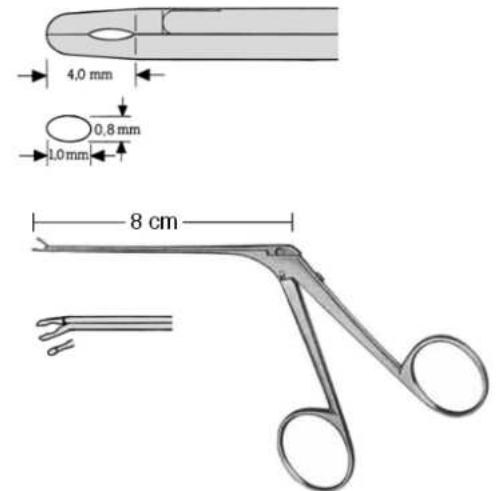

WULLSTEIN
AS-20-186-30
curved downwards

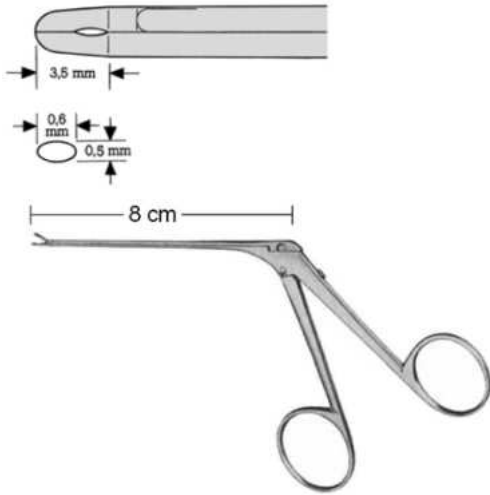

HARTMANN WULLSTEIN
AS-20-186-31
HARTMANN WULLSTEIN

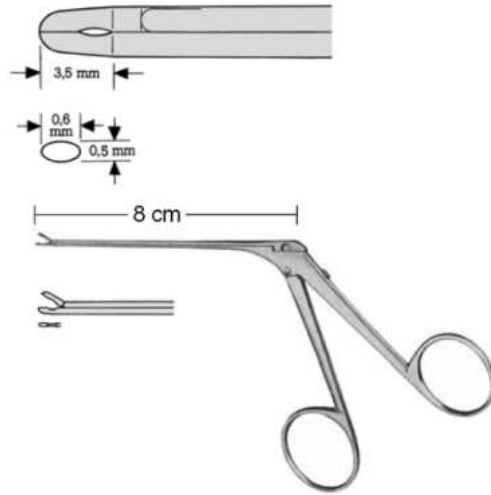

HARTMANN WULLSTEIN
AS-20-186-32
straight

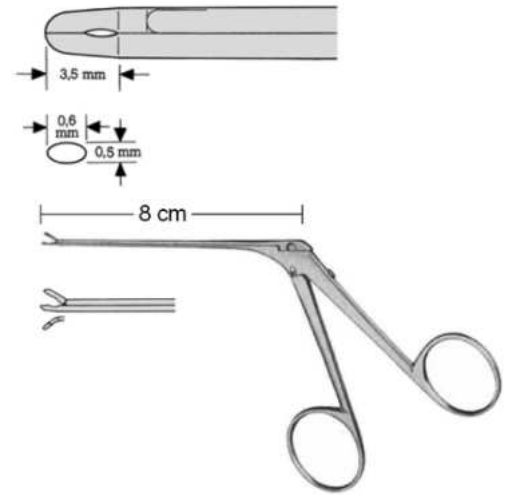

HARTMANN WULLSTEIN
AS-20-186-33
left

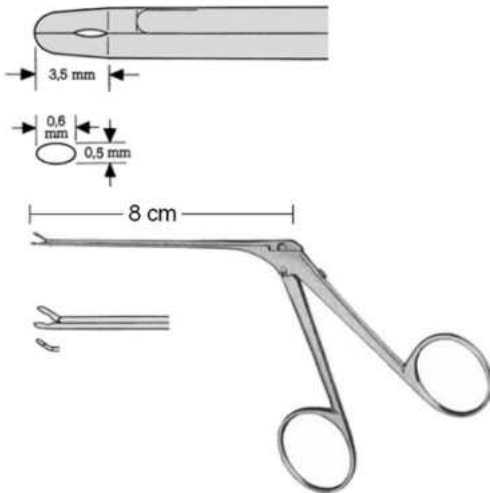

HARTMANN WULLSTEIN
AS-20-186-34
right

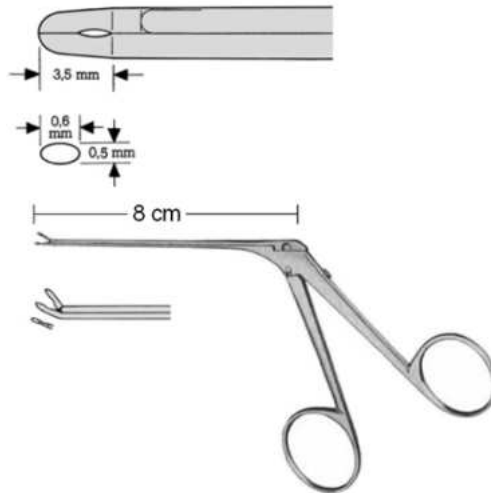

HARTMANN WULLSTEIN
AS-20-186-35
curved up

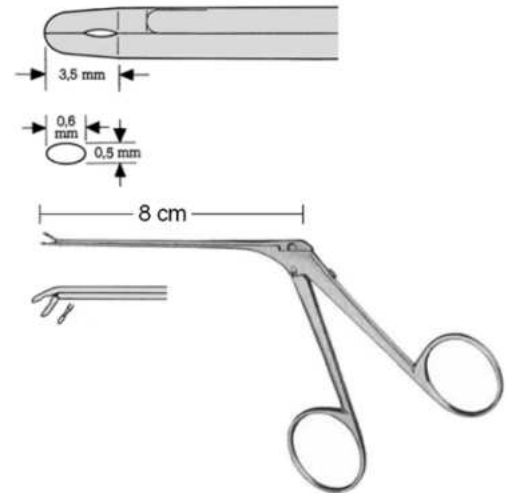

HARTMANN WULLSTEIN
AS-20-186-36
curved downwards

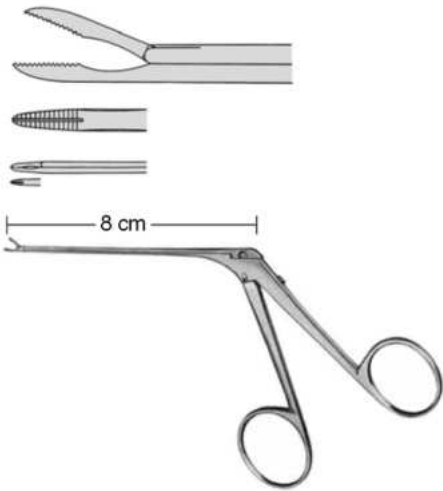

GREVEN
AS-20-186-37
 GREVEN



WULLSTEIN
AS-20-186-38
 WULLSTEIN
 1 mm Ø, 2 mm Ø,



DIETER
AS-20-186-39
 DIETER

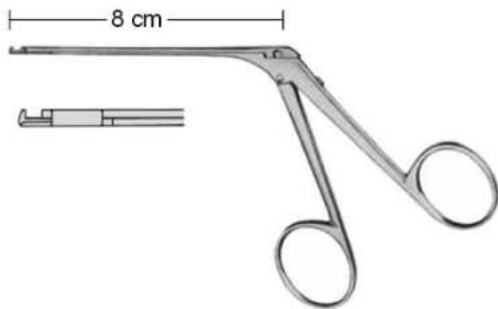

DIETER
AS-20-186-40
 up-cutting

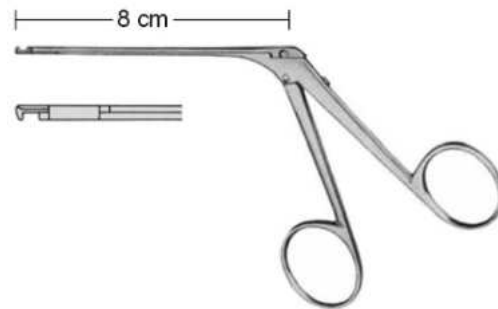

DIETER
AS-20-186-41
 down-cutting



FULLER
AS-20-186-42
 Introducing Forceps for Teflon prosthesis

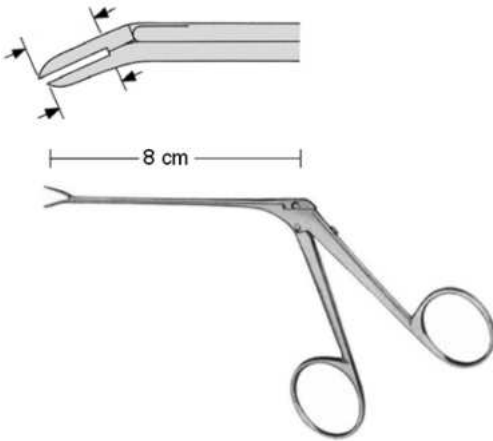

McGEE
AS-20-186-43
Wire Bending Forceps

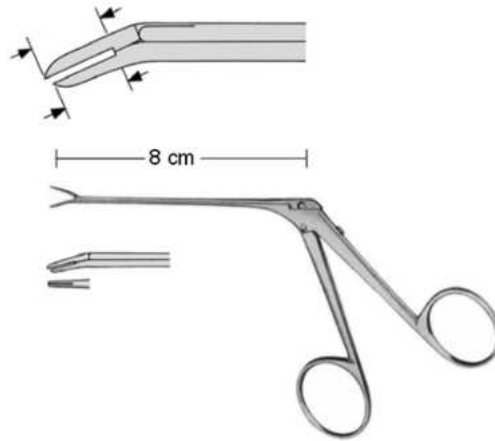

McGEE
AS-20-186-44
Wire Bending Forceps
0,8 x 3,5 mm,

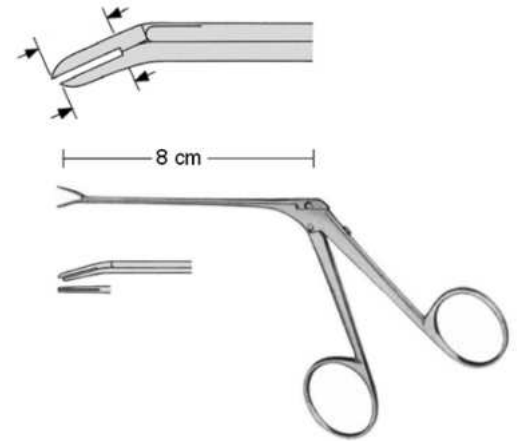

McGEE
AS-20-186-45
Wire Bending Forceps
0,8 x 6 mm,

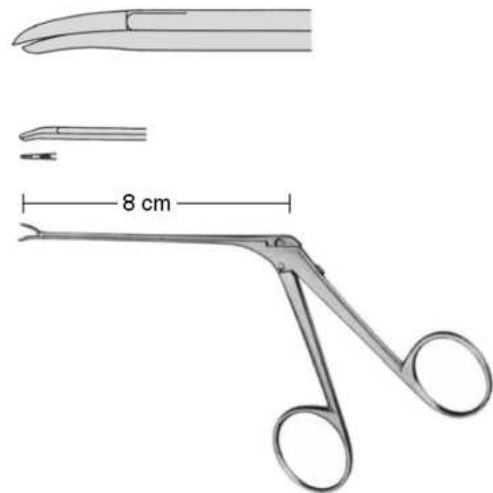

SCHUKNECHT
AS-20-186-46
SCHUKNECHT

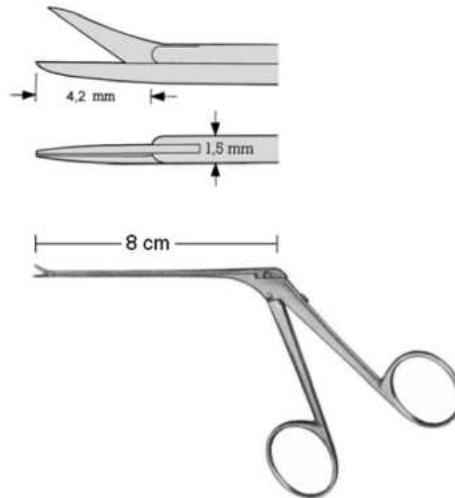

BELLUCCI
AS-20-186-47
BELLUCCI

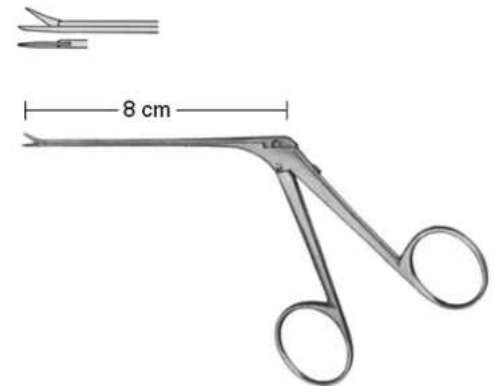

BELLUCCI
AS-20-186-48
straight

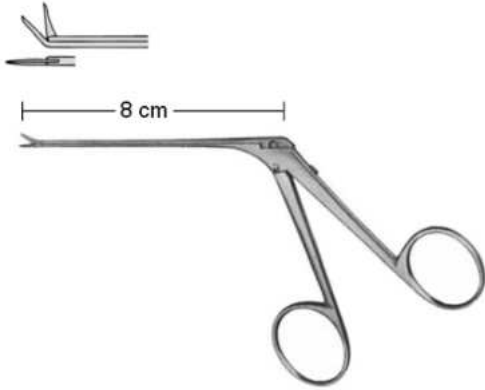

BELLUCCI
AS-20-186-49
curved up

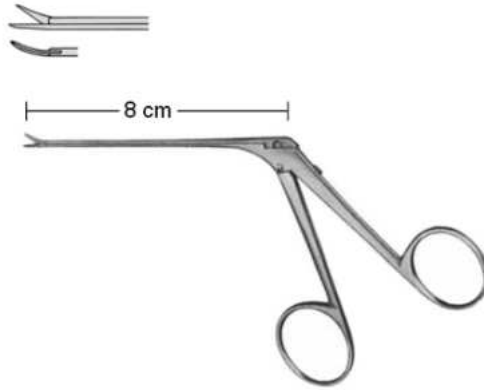

BELLUCCI
AS-20-186-50
right

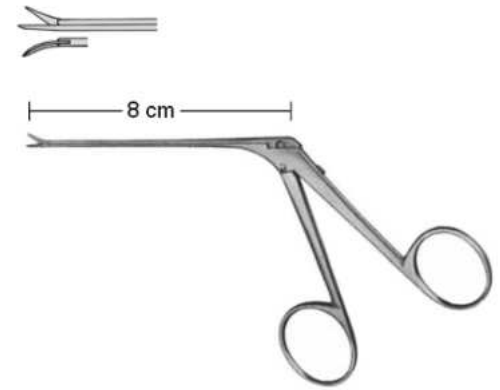

BELLUCCI
AS-20-186-51
left

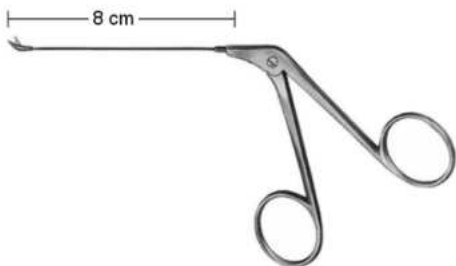
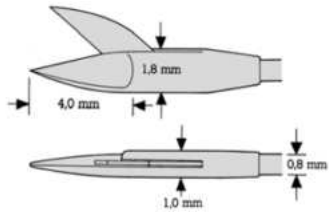

WULLSTEIN
AS-20-186-52
WULLSTEIN

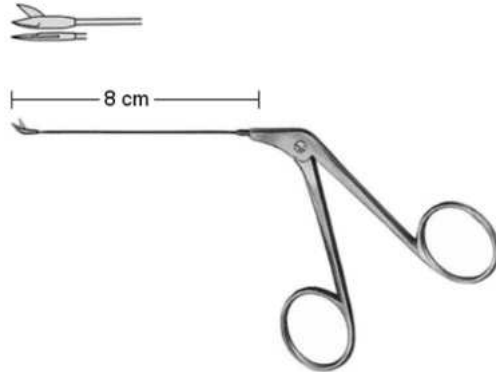

WULLSTEIN
AS-20-186-53
straight

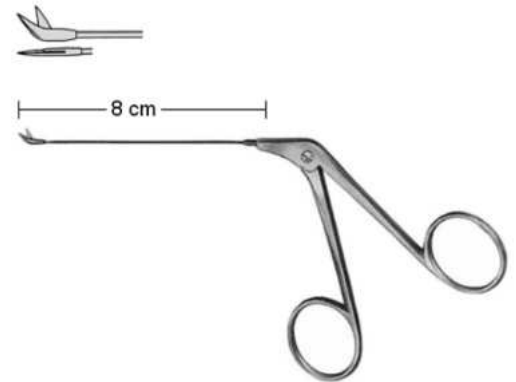

WULLSTEIN
AS-20-186-54
curved up

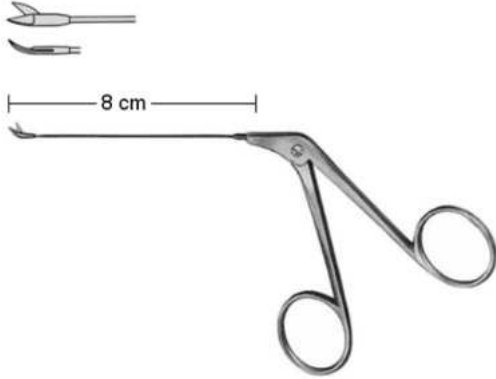

WULLSTEIN
AS-20-186-55
right

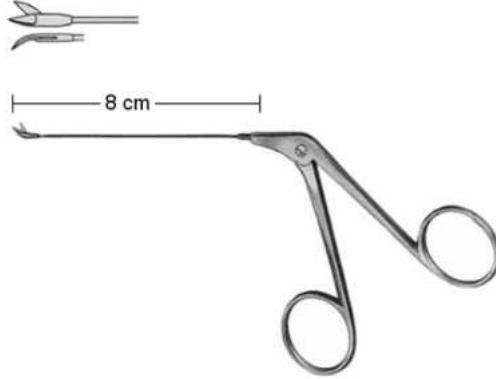

WULLSTEIN
AS-20-186-56
left



SHEA-BELLUCC
AS-20-186-57
SHEA-BELLUCC
7 mm,

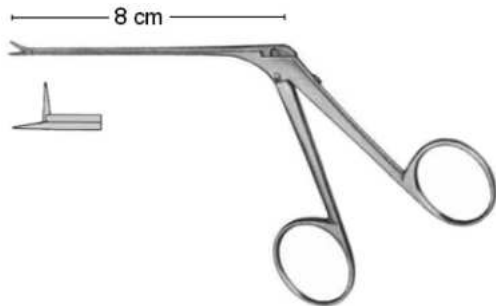

SHEA-BELLUCC
AS-20-186-58
straight



SHEA-BELLUCC
AS-20-186-59
curved up



SHEA-BELLUCC
AS-20-186-60
right

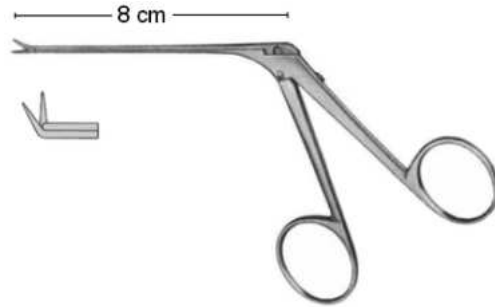

SHEA-BELLUCC
AS-20-186-61 left



JURASZ
AS-21-187-01
JURASZ
23 cm,

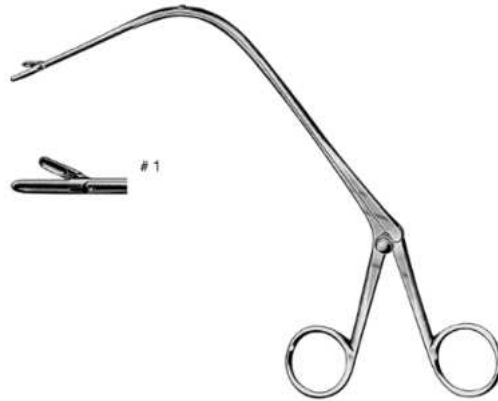

JURASZ
AS-21-187-02
opening right

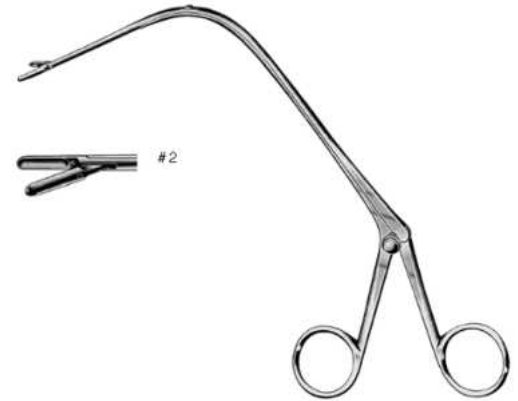

JURASZ
AS-21-187-03
opening left

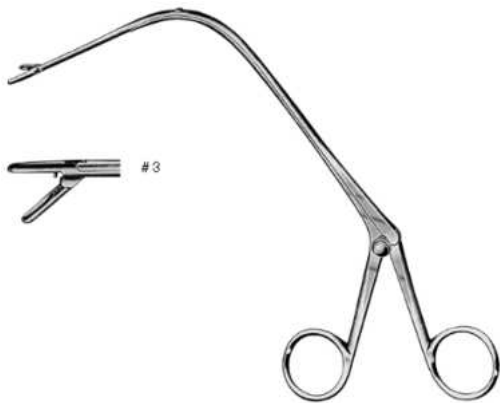

JURASZ
AS-21-187-04
opening downward

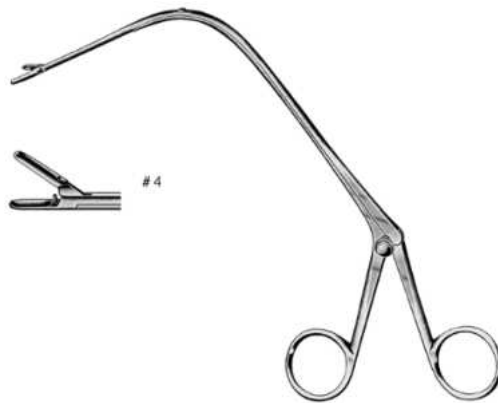

JURASZ
AS-21-187-05
opening upward



FRAENKEL
AS-21-187-06
both jaws articulated



LANGE
AS-21-187-07
both jaws articulated



HUBER
AS-21-187-08
Universal Handle for extension tubes
35.0220 - 35.0320



BRUENINGS
AS-21-187-09
Extension Tubes
20 cm,30 cm,40 cm,50 cm,60 cm,



BRUENINGS
AS-21-187-10
BRUENINGS
20 cm,

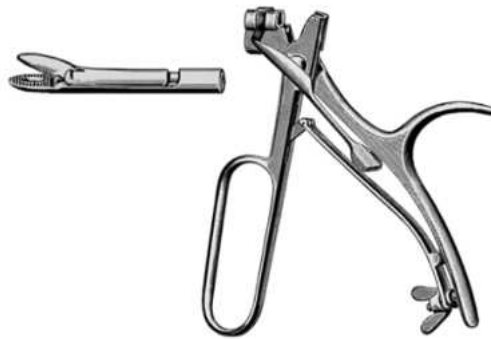

FRAENKEL
AS-21-187-11
EXCHANGEABLE TIPS

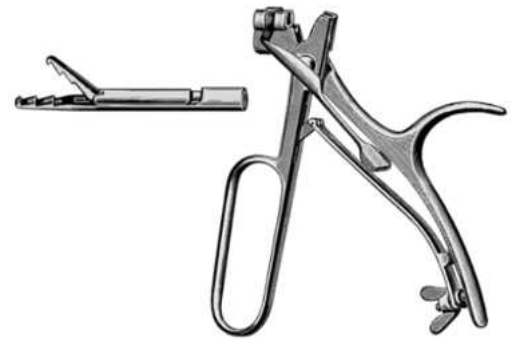

SEIFFERT
AS-21-187-12
EXCHANGEABLE TIPS

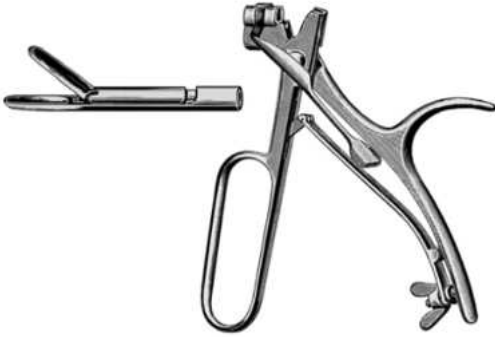

FRAENKEL
AS-21-187-13
 EXCHANGEABLE TIPS

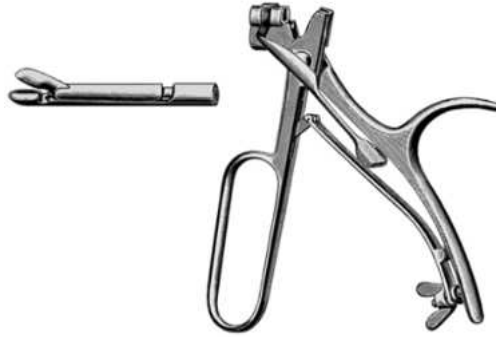

LANGE
AS-21-187-14
 EXCHANGEABLE TIPS

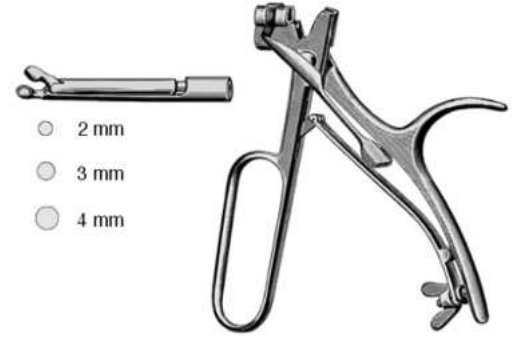

BRUENINGS
AS-21-187-15
 EXCHANGEABLE TIPS
 2 mm,3 mm,4 mm,

- 2 mm
- 3 mm
- 4 mm

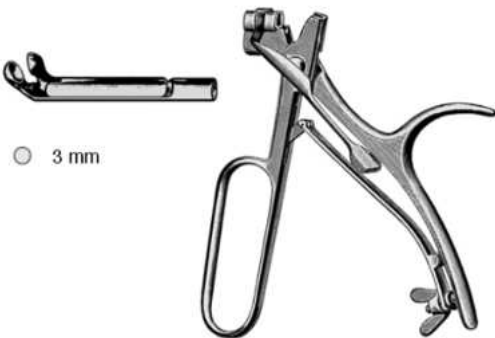

BRUENINGS
AS-21-187-16
 EXCHANGEABLE TIPS
 3 mm,

- 3 mm

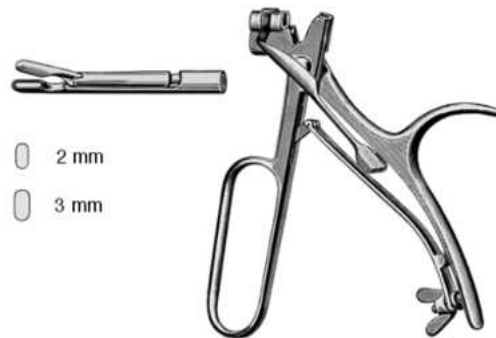

BRUENINGS
AS-21-187-17
 EXCHANGEABLE TIPS
 2 mm,3 mm,

- 2 mm
- 3 mm

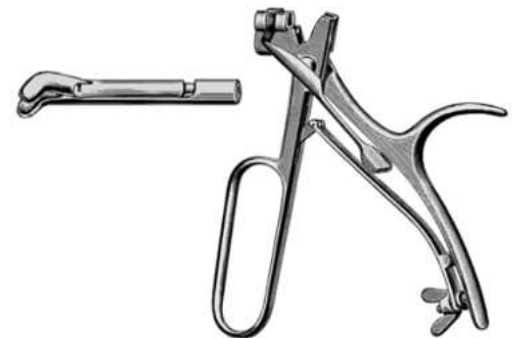

SCHEINMANN
AS-21-187-18
 EXCHANGEABLE TIPS

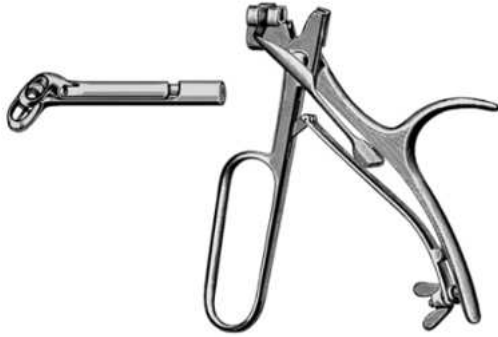

SCHEINMANN
AS-21-187-19
EXCHANGEABLE TIPS

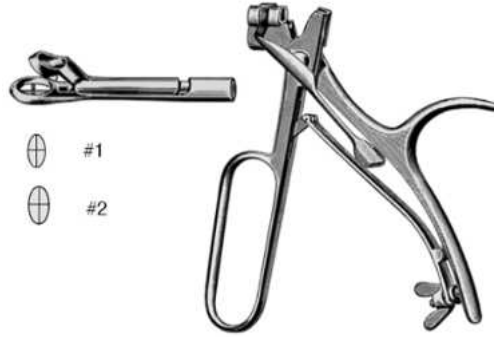

KRAUSE
AS-21-187-20
EXCHANGEABLE TIPS

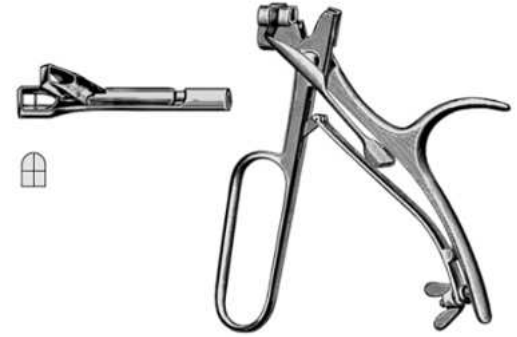

KRAUSE
AS-21-187-21
EXCHANGEABLE TIPS



SCHUMACHER
AS-21-187-22
EXCHANGEABLE TIPS

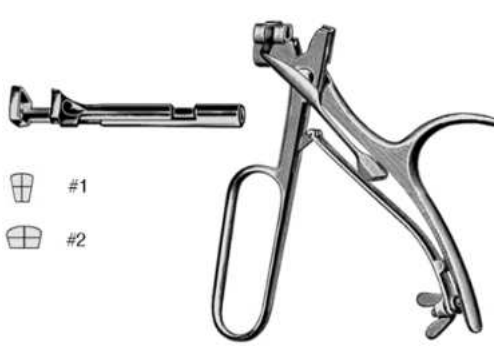

CORDES
AS-21-187-23
EXCHANGEABLE TIPS

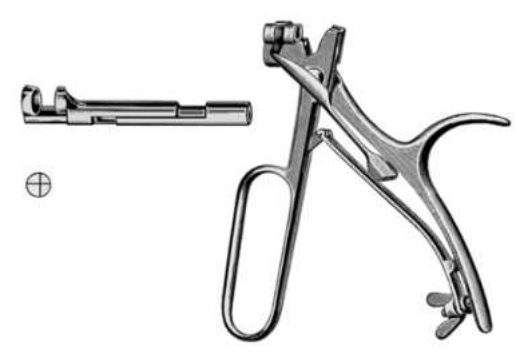

CORDES
AS-21-187-24
EXCHANGEABLE TIPS

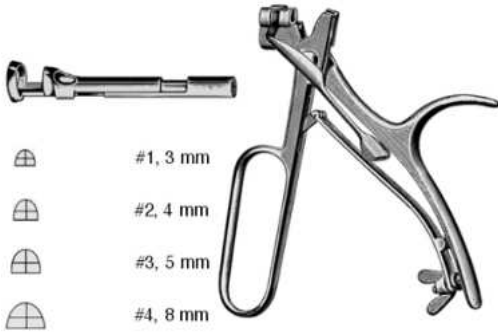

CORDES

AS-21-187-25

EXCHANGEABLE TIPS

3 mm, 4 mm, 5 mm, 4,8 mm,

ROSENBERG

AS-21-187-26

EXCHANGEABLE TIPS

CHEVALIER-JACKSON

AS-21-187-27

CHEVALIER-JACKSON



CHEVALIER-JACKSON

AS-21-187-28

CHEVALIER-JACKSON

30 cm, 40 cm, 50 cm, 60 cm,

CHEVALIER-JACKSON

AS-21-187-29

CHEVALIER-JACKSON

30 cm, 40 cm, 50 cm, 60 cm,

CHEVALIER-JACKSON

AS-21-187-30

CHEVALIER-JACKSON

30 cm, 40 cm, 50 cm, 60 cm,



CHEVALIER-JACKSON

AS-21-187-31

CHEVALIER-JACKSON

30 cm,40 cm,50 cm,60 cm,

CHEVALIER-JACKSON

AS-21-187-32

CHEVALIER-JACKSON

30 cm,40 cm,50 cm,60 cm,

CHEVALIER-JACKSON

AS-21-187-33

CHEVALIER-JACKSON

30 cm,40 cm,50 cm,60 cm,



CHEVALIER-JACKSON

AS-21-187-34

CHEVALIER-JACKSON

30 cm,40 cm,50 cm,60 cm,

LARYNGO-Bronchoscopy

AS-21-187-35

LARYNGO-Bronchoscopy

Shaft Ø 2,5 mm,

LARYNGO-Bronchoscopy

AS-21-187-36

LARYNGO-Bronchoscopy

40 cm,50 cm,60 cm,



LARYNGO-Bronchoscopy
AS-21-187-37
LARYNGO-Bronchoscopy
40 cm,50 cm,60 cm,



LARYNGO-Bronchoscopy
AS-21-187-38
LARYNGO-Bronchoscopy
40 cm,50 cm,60 cm,



LARYNGO-Bronchoscopy
AS-21-187-39
LARYNGO-Bronchoscopy
40 cm,50 cm,60 cm,



LARYNGO-Bronchoscopy
AS-21-187-40
LARYNGO-Bronchoscopy
40 cm,50 cm,60 cm,



LARYNGO-Bronchoscopy
AS-21-187-41
LARYNGO-Bronchoscopy
40 cm,50 cm,60 cm,



LARYNGO-Bronchoscopy
AS-21-187-42
LARYNGO-Bronchoscopy
40 cm,50 cm,60 cm,



LARYNGO-Bronchoscopy
AS-21-187-43
LARYNGO-Bronchoscopy
40 cm,50 cm,60 cm,



LARYNGO-Bronchoscopy
AS-21-187-44
LARYNGO-Bronchoscopy
40 cm,50 cm,60 cm,



LARYNGO-Bronchoscopy
AS-21-187-45
LARYNGO-Bronchoscopy
40 cm,50 cm,60 cm,



LARYNGO-Bronchoscopy
AS-21-187-46
LARYNGO-Bronchoscopy
40 cm,50 cm,60 cm,



LARYNGO-Bronchoscopy
AS-21-187-47
LARYNGO-Bronchoscopy
40 cm,50 cm,60 cm,



LARYNGO-Bronchoscopy
AS-21-187-48
LARYNGO-Bronchoscopy
40 cm,50 cm,60 cm,



HARTMANN
AS-22-188-01
HARTMANN
20 cm,



HARTMANN
AS-22-188-02
HARTMANN
16 cm,



LITTAUER
AS-22-188-03
LITTAUER
18 cm,



KNIGHT
AS-22-188-04
KNIGHT
18 cm,



LUBET-BARBON
AS-22-188-05
LUBET-BARBON
20 cm,



NOYES
AS-22-188-06
NOYES



NOYES
AS-22-188-07
NOYES
14,5,



NOYES
AS-22-188-08
NOYES
14,5 cm, 1x2,



BRUENINGS
AS-22-188-09
BRUENINGS
19 cm,



BRUENINGS
AS-22-188-10
BRUENINGS



BRUENINGS
AS-22-188-11
BRUENINGS

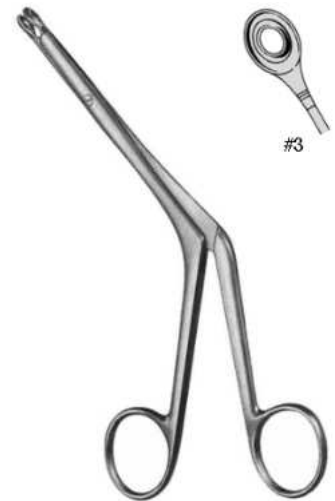

BRUENINGS
AS-22-188-12
BRUENINGS



BRUENINGS
AS-22-188-13
BRUENINGS



HEYMANN
AS-22-188-14
HEYMANN
18 cm,



HEYMANN
AS-22-188-15
HEYMANN



HEYMANN
AS-22-188-16
HEYMANN

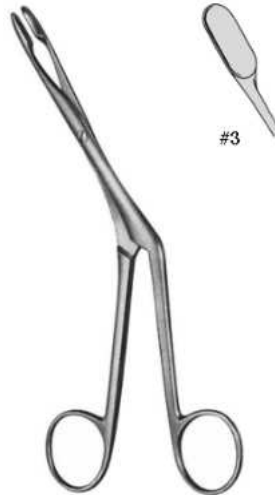

HEYMANN
AS-22-188-17
HEYMANN

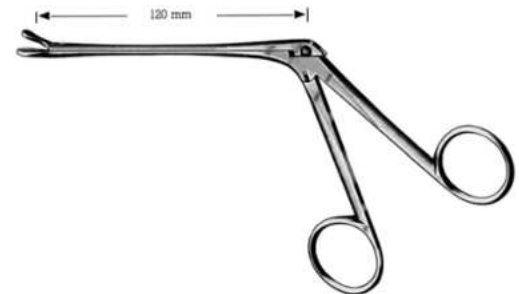

WATSON-WILLIAMS
AS-22-188-18
WATSON-WILLIAMS
19 cm,

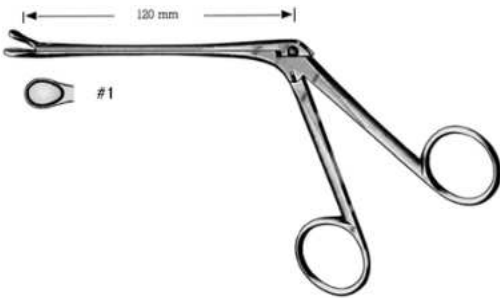

**WATSON-
WILLIAMS**
AS-22-188-19
WATSON-WILLIAMS

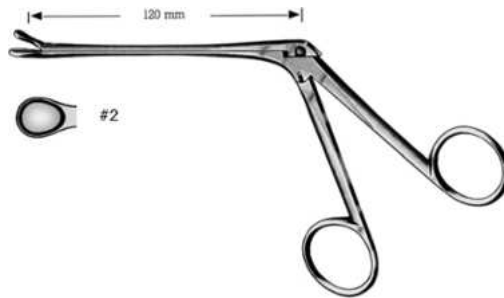

**WATSON-
WILLIAMS**
AS-22-188-20
WATSON-WILLIAMS

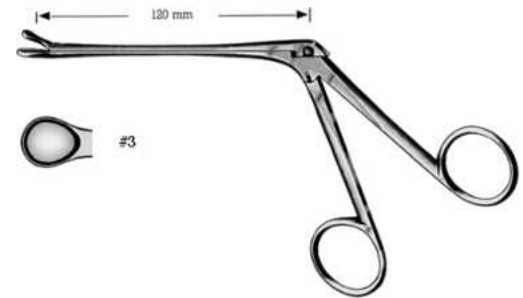

**WATSON-
WILLIAMS**
AS-22-188-21
WATSON-WILLIAMS

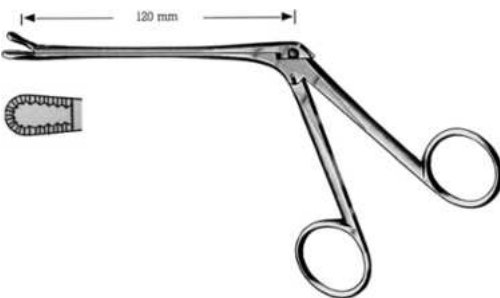

**WATSON-
WILLIAMS**
AS-22-188-22
WATSON-WILLIAMS



LUC
AS-22-188-23
LUC
19 cm,



LUC
AS-22-188-24
LUC
19 cm,



LUC
AS-22-188-25
LUC
19 cm,

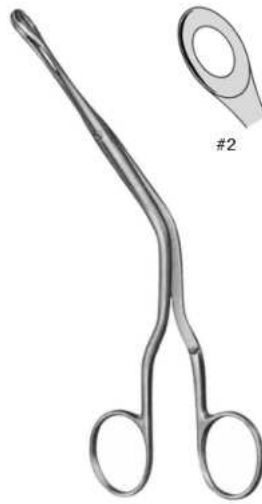

LUC
AS-22-188-26
LUC
19 cm,



CRAIG
AS-22-188-27
CRAIG
18 cm,



CRAIG
AS-22-188-28
CRAIG
18 cm,



CRAIG
AS-22-188-29
CRAIG
18 cm,



HEUWIESER
AS-22-188-30
Antrum polypus grasping forceps

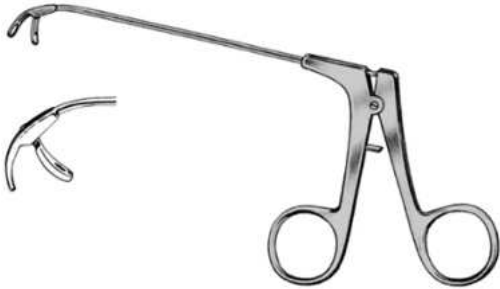

HEUWIESER
AS-22-188-31
down

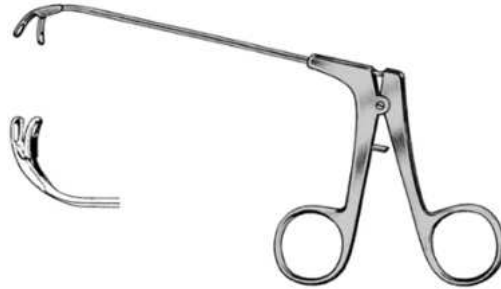

HEUWIESER
AS-22-188-32
up

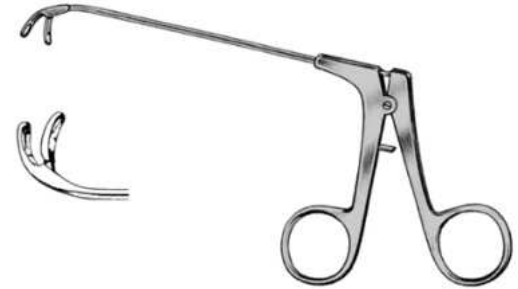

HEUWIESER
AS-22-188-33
right

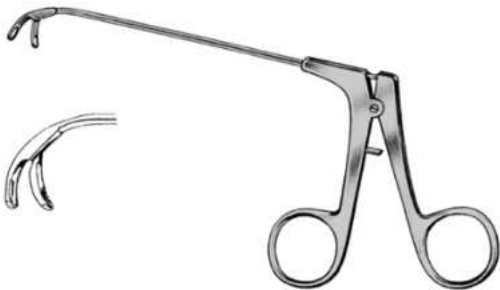

HEUWIESER
AS-22-188-34
left



JANSEN-MIDDLETON
AS-22-188-35
JANSEN-MIDDLETON
19 cm,



JANSEN-MIDDLETON
AS-22-188-36
JANSEN-MIDDLETON
19 cm,



STRUYCKEN
AS-22-188-37
 STRUYCKEN
 19 cm,



SCHMEDEN
AS-22-188-38
 SCHMEDEN
 11 mm,



STRUYCKEN
AS-22-188-39
 STRUYCKEN



STRUYCKEN
AS-22-188-40
 STRUYCKEN



MYLES
AS-22-188-41
 MYLES

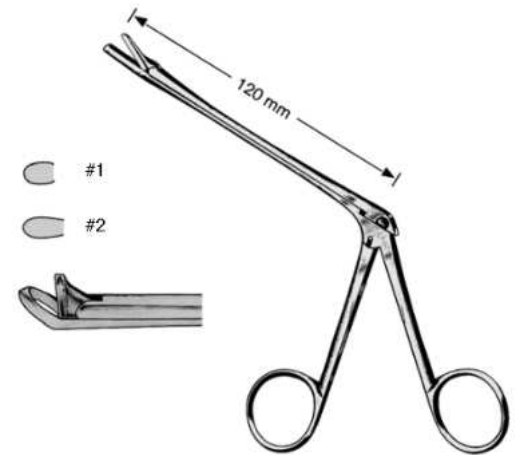

WATSON-WILLIAMS
AS-22-188-42
 WATSON-WILLIAMS
 13 cm,



WEIL-BLAKESLEY
AS-22-188-43
without neck
19 cm,



WEIL-BLAKESLEY
AS-22-188-44
WEIL-BLAKESLEY



WEIL-BLAKESLEY
AS-22-188-45
WEIL-BLAKESLEY



WEIL-BLAKESLEY
AS-22-188-46
without neck



WEIL-BLAKESLEY
AS-22-188-47
without neck



WEIL-BLAKESLEY
AS-22-188-48
without neck



WEIL-BLAKESLEY
AS-22-188-49
with neck
19 cm,

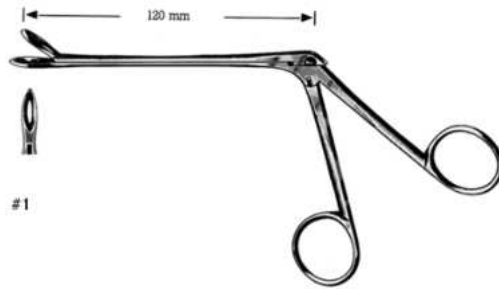

WEIL-BLAKESLEY
AS-22-188-50
with neck



WEIL-BLAKESLEY
AS-22-188-51
with neck



WEIL-BLAKESLEY
AS-22-188-52
with neck



WEIL-BLAKESLEY
AS-22-188-53
with neck



WEIL-BLAKESLEY
AS-22-188-54
with neck



WEIL-BLAKESLEY
AS-22-188-55
WEIL-BLAKESLEY
20 cm,



#1 3,0mm

WEIL-BLAKESLEY
AS-22-188-56
WEIL-BLAKESLEY
3,0mm,



#2 3,5mm

WEIL-BLAKESLEY
AS-22-188-57
WEIL-BLAKESLEY
3,5mm,



#3 4,0mm

WEIL-BLAKESLEY
AS-22-188-58
WEIL-BLAKESLEY
4,0mm,



#4 4,5mm

WEIL-BLAKESLEY
AS-22-188-59
WEIL-BLAKESLEY
4,5mm,



#5 5,5mm

WEIL-BLAKESLEY
AS-22-188-60
WEIL-BLAKESLEY
5,5mm,



WEIL-BLAKESLEY
AS-22-188-61
WEIL-BLAKESLEY



WEIL-BLAKESLEY
AS-22-188-62
WEIL-BLAKESLEY
3,0mm,



WEIL-BLAKESLEY
AS-22-188-63
WEIL-BLAKESLEY
3,5mm,



WEIL-BLAKESLEY
AS-22-188-64
WEIL-BLAKESLEY
4,5mm,



WEIL-BLAKESLEY
AS-22-188-65
WEIL-BLAKESLEY
5,0mm,



TAKAHASHI
AS-22-188-66
TAKAHASHI
19 cm,

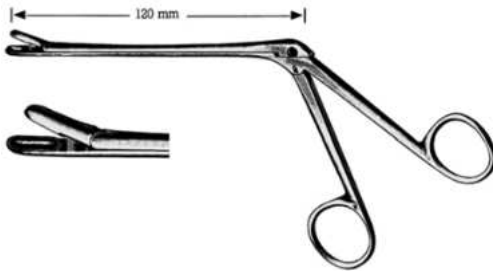

TAKAHASHI
AS-22-188-67
TAKAHASHI

2x10 mm, 3x10 mm, 4x10 mm,

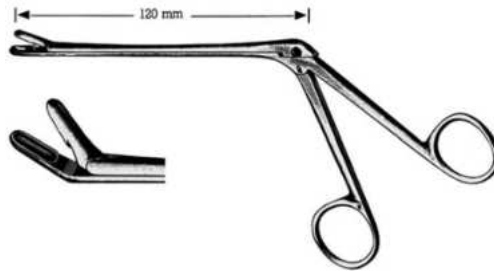

TAKAHASHI
AS-22-188-68
TAKAHASHI

2x10 mm, 3x10 mm, 4x10 mm,

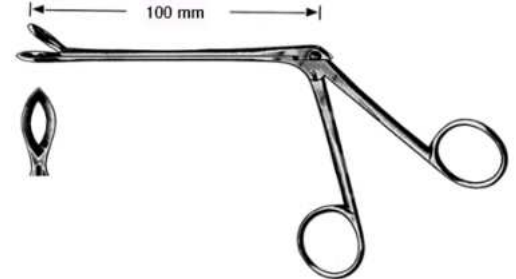

TILLEY-HENCKEL
AS-22-188-69
TILLEY-HENCKEL

6,5 mm,



OSTROM
AS-22-188-70

without illustration: rotating
100 mm,



OSTROM
AS-22-188-71

upside backward cutting



OSTROM
AS-22-188-72

right side, backward cutting



OSTROM
AS-22-188-73
left side, backward cutting



HARTMANN
AS-22-188-74
HARTMANN



HARTMANN
AS-22-188-75
HARTMANN
5 mm,



HARTMANN
AS-22-188-76
HARTMANN
7 mm,



HARTMANN
AS-22-188-77
HARTMANN
9 mm,



HARTMANN
AS-22-188-78
HARTMANN
11 mm,



13 mm

HARTMANN
AS-22-188-79
HARTMANN
13 mm,



15 mm

HARTMANN
AS-22-188-80
HARTMANN
15 mm,



17 mm

HARTMANN
AS-22-188-81
HARTMANN
17 mm,

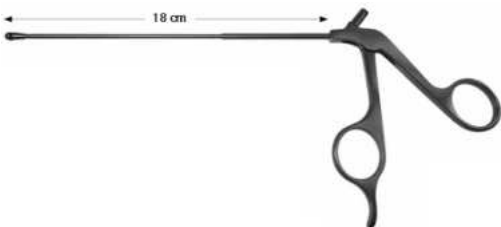

18 cm

STAMMBERGER
AS-22-188-82
STAMMBERGER
27 cm,

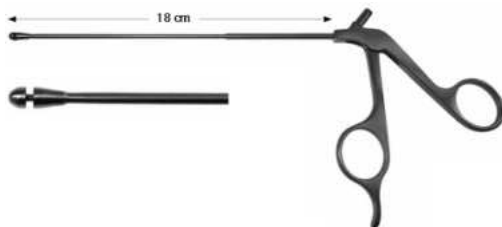

18 cm

STAMMBERGER
AS-22-188-83
straight
Ø 3,5 mm ,

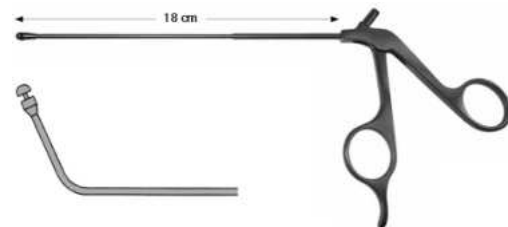

18 cm

STAMMBERGER
AS-22-188-84
up-curved
65° Ø 3,5 mm ,65° Ø 4,5 mm ,



KERRISON
AS-22-188-85
KERRISON

3 mm, 4 mm, 5 mm, 6 mm,



HAJEK-KOFLER
AS-22-188-86
HAJEK-KOFLER



HAJEK-KOFLER
AS-22-188-87
HAJEK-KOFLER
3,5 mm,



HAJEK-KOFLER
AS-22-188-88
HAJEK-KOFLER
4 mm,



HAJEK-KOFLER
AS-22-188-89
HAJEK-KOFLER
3,5 mm,



HAJEK-KOFLER
AS-22-188-90
HAJEK-KOFLER
4 mm,



HAJEK-CLAUS
AS-22-188-91
HAJEK-CLAUS
20 cm,



CITELLI
AS-22-188-92
CITELLI
5 mm, 2 mm, 3 mm,



BEYER
AS-22-188-93
BEYER
18 cm, 2 mm,



CONTACT US

Address: P.O Box 1176 Small Industries
Estate, Sialkot Pakistan

Fax: +92 3131552033

Tell: +92 3336118001

E-mail: inquiry@akcantsurgical.com