

AKCANT

SURGICAL

Dental Instruments



Extracting Forceps - English Pattern



AK-1006
Fig 19
upper wisdoms



AK-1007
Fig 20
lower wisdoms

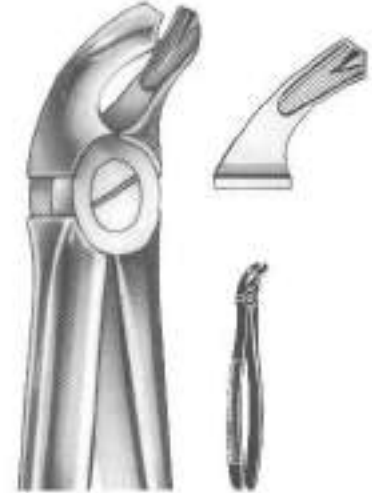

AK-1008
Fig 21
lower molars



AK-1009
Fig 22
lower molars



AK-1010
Fig 22 A
Albrecht
lower molars

Extracting Forceps - English Pattern



AK-1001
Fig 8
lower premolars



AK-1002
Fig 13
lower premolars



AK-1003
Fig 17
upper molars, right



AK-1004
Fig 18
upper molars, left



AK-1005
Fig 18 A
upper molars

Extracting Forceps - English Pattern



AK-1011
Fig 33 A
lower roots



AK-1012
Fig 33 B
lower roots

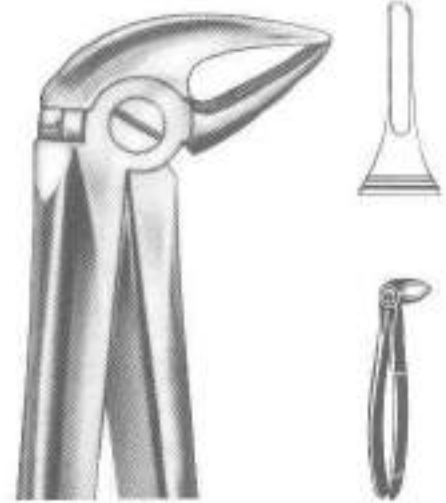

AK-1013
Fig 33 L
lower roots



AK-1014
Fig 33 L
lower roots



AK-1015
Fig 33 S
lower roots, for children

Extracting Forceps - English Pattern



AK-1016
Fig 44
upper roots



AK-1017
Fig 45
lower roots

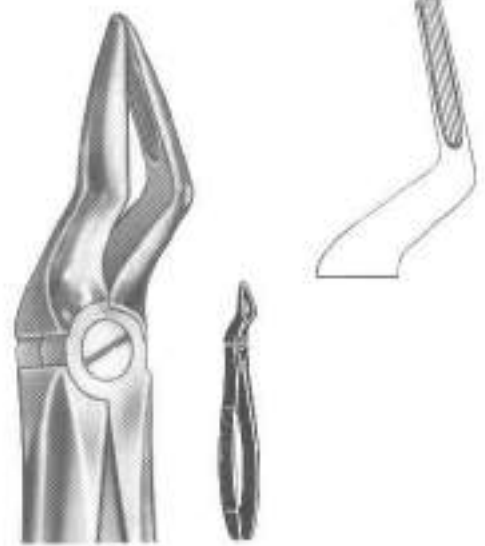

AK-1018
Fig 12
upper roots



AK-1019
Fig 51 A
upper roots

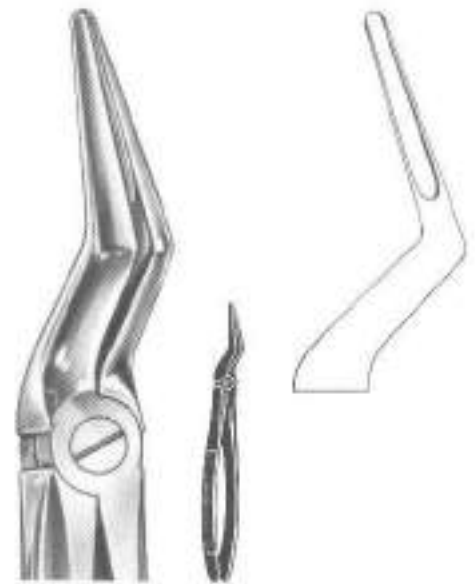

AK-1020
Fig 51 L
upper roots

"Relax" - Extracting Forceps



Relax
AK-1021
Fig 51
upper roots



Relax
AK-1022
Fig 51 A
upper roots



Relax
AK-1023
Fig 51 L
upper roots



Relax
AK-1024
Fig 67
upper wisdoms



Relax
AK-1025
Fig 67 A
upper wisdoms

"Relax" - Extracting Forceps



1026
Fig 37
Upper incisors

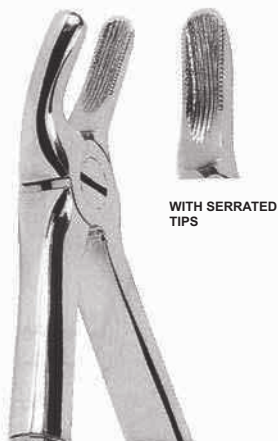

1027
Fig 39
Upper molars

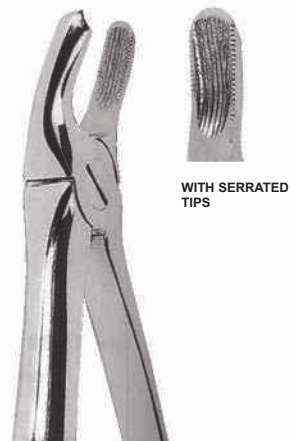

1028
Fig 39 R
Upper molars, right

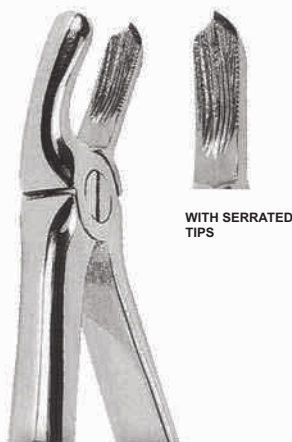

1029
Fig 39 L
Upper molars, left



1030
Fig 515
Upper roots

Extracting Forceps For Children, English Patte...



Klein
AK-1031
Fig 6
lower molars



Klein
AK-1032
Fig 137
upper incisors



Klein
AK-1033
Fig 5
lower incisors

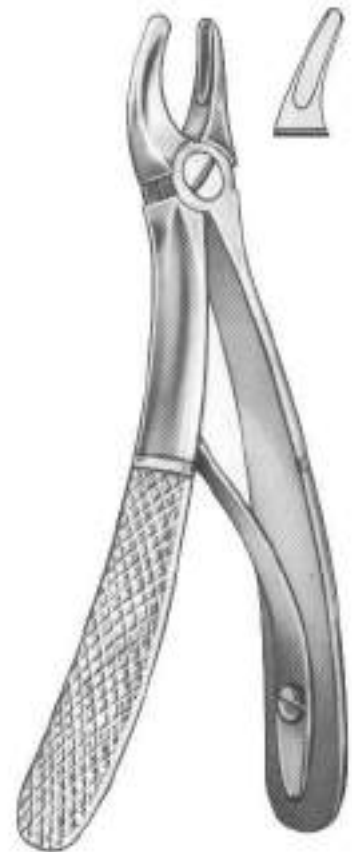

Klein
AK-1034
Fig 139
uper premolars

Extracting Forceps - English Pattern



WITH SERRATED TIPS

AK-1035
Fig 43 A
Fractured or decayed upper teeth



WITH SERRATED TIPS

AK-1036
Fig 44
Upper roots



WITH SERRATED TIPS

AK-1037
Fig 45
Lower roots



WITH SERRATED TIPS

AK-1038
Fig 46
Lower roots



WITH SERRATED TIPS

AK-1039
Fig 46 L
Lower roots

Extracting Forceps - English Pattern



AK-1050
Fig 59
Lower roots



AK-1051
Fig 59 L
Lower incisor
roots



AK-1052
Fig 60
Lower roots



AK-1053
Fig 65 L
Upper molars, left



AK-1054
Fig 65 R
Upper molars, right

Extracting Forceps - English Pattern



WITH SERRATED TIPS

AK-1055
Fig 66 L
Upper molars, left



WITH SERRATED TIPS

AK-1056
Fig 66 R
Upper molars, right



WITH SERRATED TIPS

AK-1057
Fig 67
Upper three molars



WITH SERRATED TIPS

AK-1058
Fig 67 A
Upper third molars



WITH SERRATED TIPS

AK-1059
Fig 68
Lower roots

Extracting Forceps - English Pattern



AK-1060
Fig 67½ L
Upper third molars, left



AK-1061
Fig 67½ R
Upper third molars, right



AK-1062
Fig 73
Lower molars



AK-1063
Fig 74
Lower roots

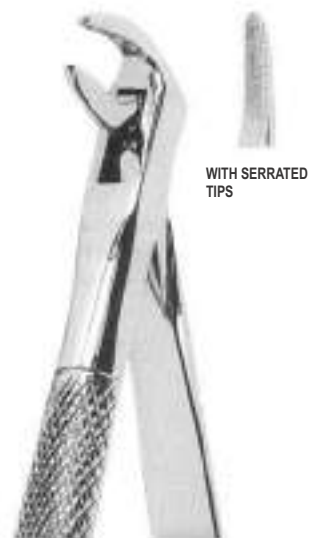

AK-1064
Fig 74 M
Lower roots

Extracting Forceps - English Pattern



AK-1065
Fig 74 N
Lower roots



AK-1066
Fig 75
Lower canines and
premolars

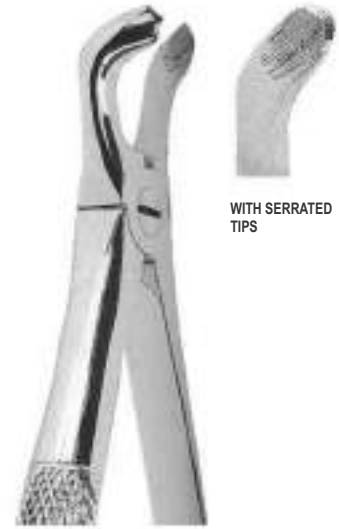

AK-1067
Fig 79
Lower third molars

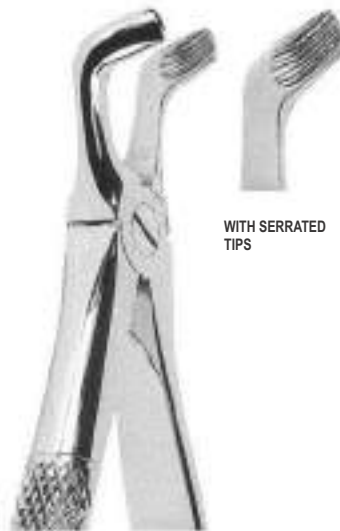

AK-1068
Fig 79 A
Lower third molars

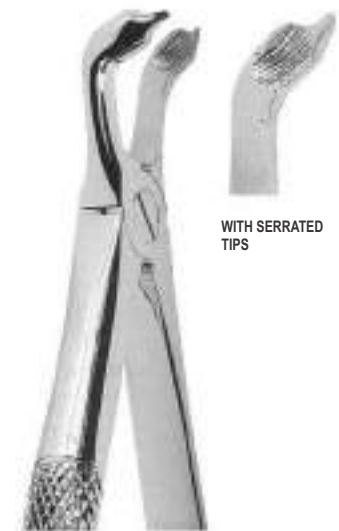

AK-1069
Fig 79 C
Lower third molars

Extracting Forceps - English Pattern



AK-1070
Fig 86 W
Lower third molars



AK-1071
Fig 86 1/2 L
Lower third molars, left



AK-1072
Fig 86 1/2 R
Lower third molars, right



AK-1073
Fig 86 C
Lower molars

Extracting Forceps - English Pattern



AK-1074
Fig 87
Lower decayed molars
or broken-down crowns



WITH SERRATED
TIPS

AK-1075
Fig 89
Upper molars, right



WITH SERRATED
TIPS

AK-1076
Fig 90
Upper molars, left



WITH SERRATED
TIPS

AK-1077
Fig 99
Broken-down lower molars



WITH SERRATED
TIPS

AK-1078
Fig 107
Upper canines

Extracting Forceps - English Pattern



AK-1079
Fig 121
Upper third molars



AK-1080
Fig 145
Lower roots



AK-1081
Fig 151½
Upper roots



AK-1082
Fig 166
Universal extracting forceps for upper teeth, in particular molars and premolars



AK-1083
Fig 167
Universal extracting forceps for lower teeth, in particular molars and premolars

Extracting Forceps - English Pattern



AK-1084
Fig 168
Upper canines



AK-1085
Fig 169
Lower canines

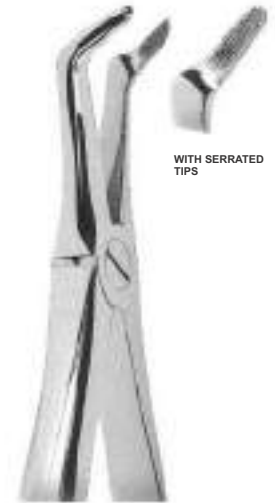

AK-1086
Fig 346
Lower roots



AK-1087
Fig 349
Upper roots

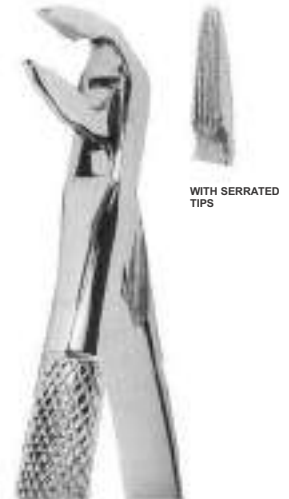

AK-1088
Fig 359
Lower roots

Extracting Forceps - Mead Pattern



AK-1089
Fig 1
Universal extracting forcep for upper incisors and canines



AK-1090
Fig 2
Upper molars



AK-1091
Fig 3
Lower incisors, premolar and roots



AK-1092
Fig 4
Lower molars

ting Forceps With Anatomically Shaped Handle



AK-1093
Fig 1
Upper incisors
and canines

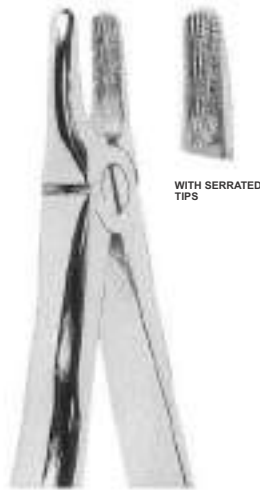

AK-1094
Fig 2
Upper incisors
and canines

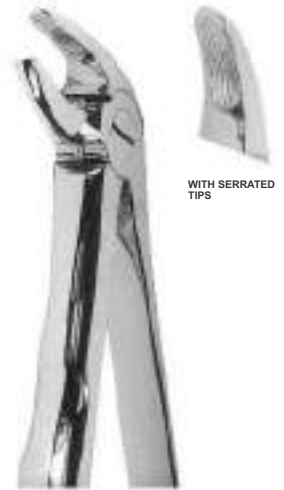

AK-1095
Fig 4
Lower incisors
and canines



AK-1096
Fig 7
Upper premolars



AK-1097
Fig 13
Lower premolars

Extracting Forceps With Anatomically Shaped H...



AK-1098
Fig 17
Upper molars, right



WITH SERRATED TIPS

AK-1099
Fig 18
Upper molars, left



WITH SERRATED TIPS

AK-1100
Fig 21
Lower molars

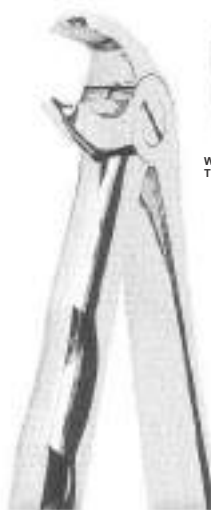

WITH SERRATED TIPS

AK-1101
Fig 22
Lower molars



WITH SERRATED TIPS

AK-1102
Fig 33
Lower roots

Extracting Forceps With Anatomically Shaped Handle



AK-1110
Fig 89
Upper molars, right



AK-1111
Fig 90
Upper molars, left

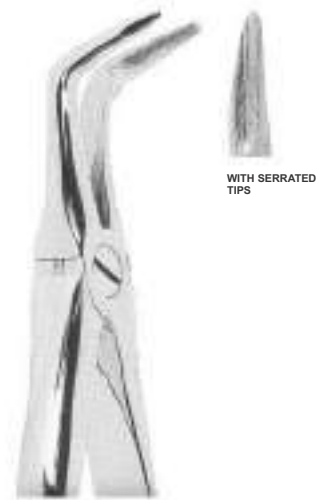

AK-1112
Fig 145
Lower roots



AK-1113
Fig 151 1/2
Upper roots

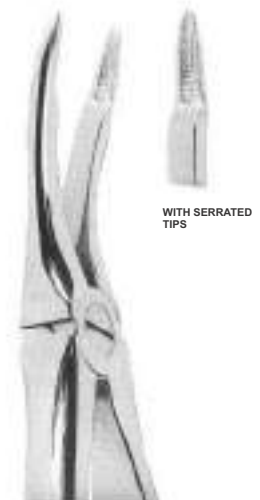

AK-1114
Fig 349
Upper roots

Extracting Forceps With Anatomically Shaped Ha



AK-1103
Fig 45
Lower roots



WITH SERRATED TIPS



AK-1104
Fig 51 A
Upper roots

WITH SERRATED TIPS



AK-1105
Fig 67 A
Upper third molars

WITH SERRATED TIPS



AK-1106
Fig 74
Lower roots

WITH SERRATED TIPS



AK-1107
Fig 79
Lower third molars

WITH SERRATED TIPS

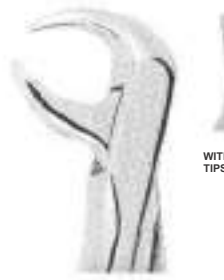

AK-1108
Fig 86 C
Lower molars

WITH SERRATED TIPS



AK-1109
Fig 359
Lower roots

WITH SERRATED TIPS

Extracting Forceps - American Pattern



AK-1115
Fig 5
Lower third molars



AK-1116
Fig 6
Separating forcep



AK-1117
Fig 105
Upper molars



AK-1118
Fig 16
Lower molars



AK-1119
Fig 17
Lower molars

Extracting Forceps - American Pattern



AK-1120
Fig 18 L
Upper molars, left



AK-1121
Fig 18 R
Upper molars, right



AK-1122
Fig 23
Lower molars



AK-1123
Fig 53 R
Upper molars, right



AK-1124
Fig 53 L
Upper molars, left

Extracting Forceps - American Pattern



AK-1125
Fig 65
Upper incisors and roots



AK-1126
Fig 69
Upper and lower roots



AK-1127
Fig 88 R
Upper molars, right



AK-1128
Fig 88 L
Upper molars, left

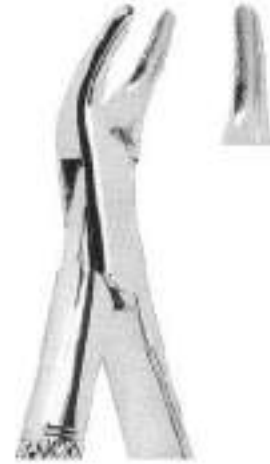

AK-1129
Fig 101
Deciduous teeth

Extracting Forceps - American Pattern



AK-1130
Fig 150
Upper incisors, premolars, roots



AK-1131
Fig 150 S
Upper teeth (for children)



AK-1132
Fig 151
Upper incisors, premolars, roots



AK-1133
Fig 151S
Lower teeth (for children)



AK-1134
Fig 222
Lower third molars

Extracting Forceps - American Pattern



AK-1135
Fig 1
upper incisors and bicuspids



AK-1136
Fig 1 B
upper roots, anterior



Physick
AK-1137
Fig 5
lower wisdoms



AK-1138
Fig 6
lower molars, splitting forceps



AK-1139
Fig 10 H
upper molars

Extracting Forceps For Children - English Pattern



WITH SERRATED TIPS

AK-1140
Fig 135
Lower premolars



AK-1141
Fig 225
Lower molars



AK-1142
Fig 305
Upper incisors and roots



WITH SERRATED TIPS

AK-1143
Fig 33 S
Lower roots



WITH SERRATED TIPS

AK-1144
Fig 38
Lower incisors and canines

Extracting Forceps For Children - Klein Pattern



AK-1145
Fig 1
Upper incisors



AK-1146
Fig 2
Upper premolars



AK-1147
Fig 3
Upper molars



AK-1148
Fig 4
Upper roots



AK-1149
Fig 5
Lower incisors



AK-1150
Fig 6
Lower molars



AK-1151
Fig 7
Lower roots

Root Splinter Extracting Forceps



AK-1152
Fig 1
Lower roots



AK-1153
Fig 2
Upper roots



AK-1155
Fig 2
Roots fragments



AK-1154
Fig 1
Roots fragments

Root Elevators

lower jaw, left side

lower jaw, right side

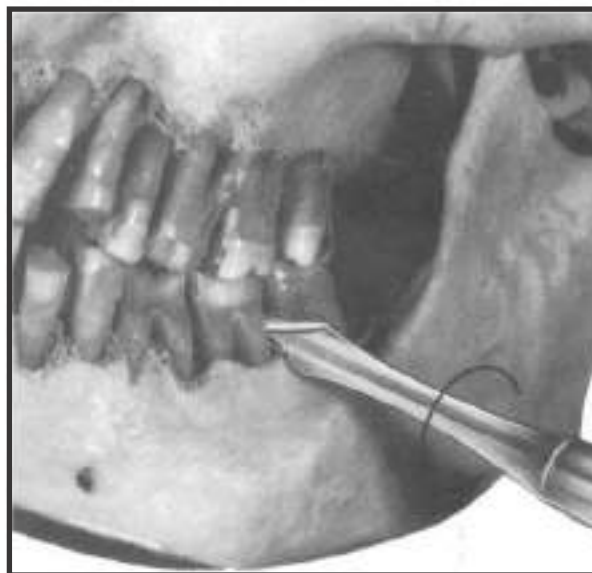

AK-1200



AK-1201

Root elevator, spiral-shaped, for extremely facilitated extraction of the molars in the lower jaw. The slender, conical points allow deep penetration between tooth and gum. Owing to the hook-shaped working parts, slipping of the elevator is avoided.

Root Elevators



Bein



Bein
AK-1202
Fig 1



Bein
AK-1203
Fig 2



Bein
AK-1204
Fig 0



Bein
AK-1205
Fig 3



Bein
AK-1206
Fig 4



Bein
AK-1207
Fig 5



Bein
AK-1208
Fig 6



Seldin



Seldin
AK-1209
Fig 1L



Seldin
AK-1210
Fig 1R



Seldin
AK-1211
Fig 2



Seldin
AK-1212
Fig 3



Seldin
AK-1213
Fig 4L



Seldin
AK-1214
Fig 4R

Root Elevators



**Cryer
AK-1215**
Fig 3



**Cryer
AK-1216**
Fig 4



**Cryer
AK-1217**
Fig 12



**Cryer
AK-1218**
Fig 27



**Cryer
AK-1219**
Fig 28



**Cryer
AK-1220**
Fig 27 S



**Cryer
AK-1221**
Fig 28 S



Apical



Apical
AK-1222
Fig 1



Apical
AK-1223
Fig 2



Apical
AK-1224
Fig 3



Apical
AK-1225
Fig 4

Root Elevators

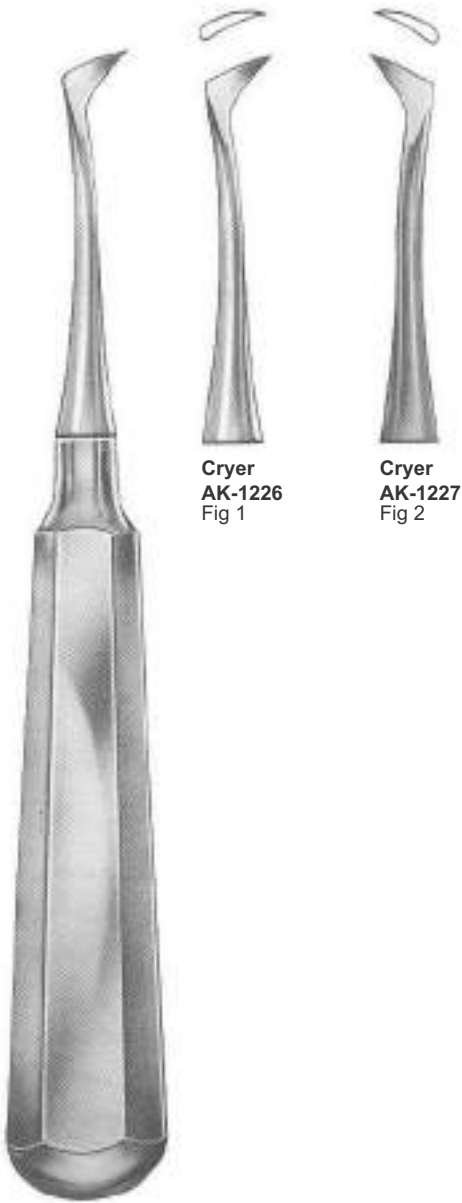

Cryer
AK-1226
Fig 1

Cryer
AK-1227
Fig 2

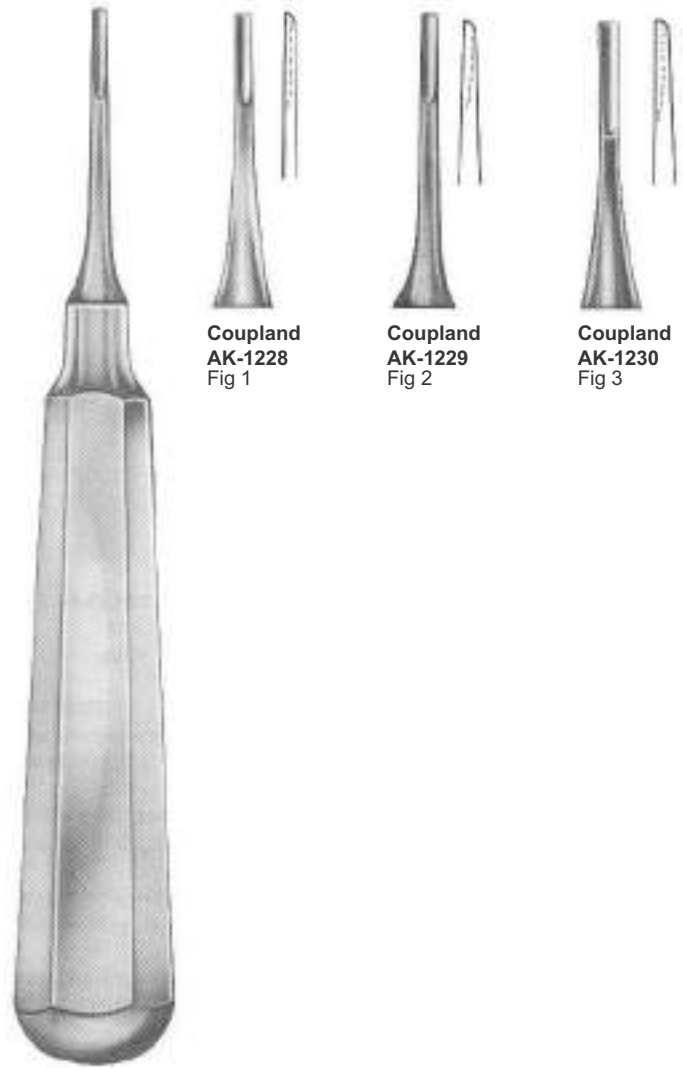

Coupland
AK-1228
Fig 1

Coupland
AK-1229
Fig 2

Coupland
AK-1230
Fig 3

Cryer

Coupland

Root Elevators



AK-1231
Fig 1



AK-1232
Fig 2



AK-1233
Fig 3



Flohr
AK-1234
Fig 1



Flohr
AK-1235
Fig 2



Flohr
AK-1236
Fig 3

Root Elevators



Kopp
AK-1237
Fig 1



Kopp
AK-1238
Fig 2



Kopp
AK-1243
Fig 1



Kopp
AK-1244
Fig 2



Kopp



Kopp
AK-1239
Fig 3



Kopp
AK-1240
Fig 4



Kopp



Kopp
AK-1245
Fig 3



Kopp
AK-1246
Fig 4



Kopp
AK-1241
Fig 5



Kopp
AK-1242
Fig 6



Hylin
AK-1247
Fig 1

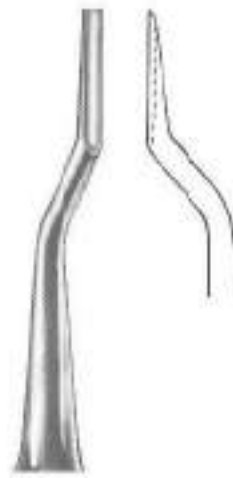

Bein
AK-1249
Fig 1

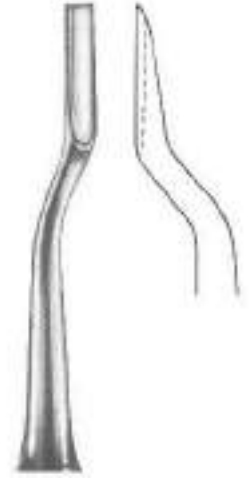

Bein
AK-1250
Fig 2



Hylin



Hylin
AK-1248
Fig 2



Bein



Bein
AK-1251
Fig 3

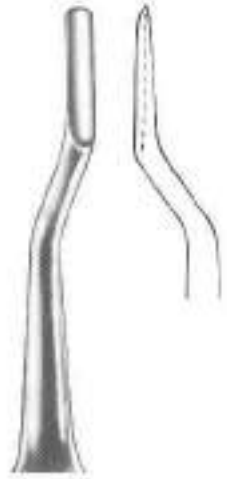

Bein
AK-1252
Fig 4

Root Elevators



Warwick-James
AK-1253
Fig 1



Warwick-James
AK-1254
Fig 2



Warwick-James
AK-1255
Fig 3



London Hospital
AK-1256
Fig 1



London Hospital
AK-1257
Fig 2



London Hospital
AK-1258
Fig 3



Ott
AK-1259

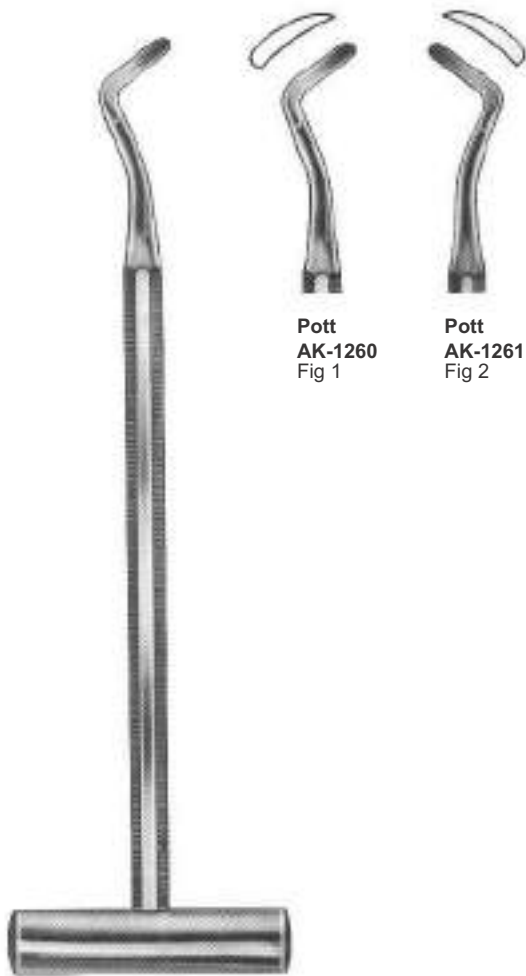

Pott
AK-1260
Fig 1

Pott
AK-1261
Fig 2

Pott

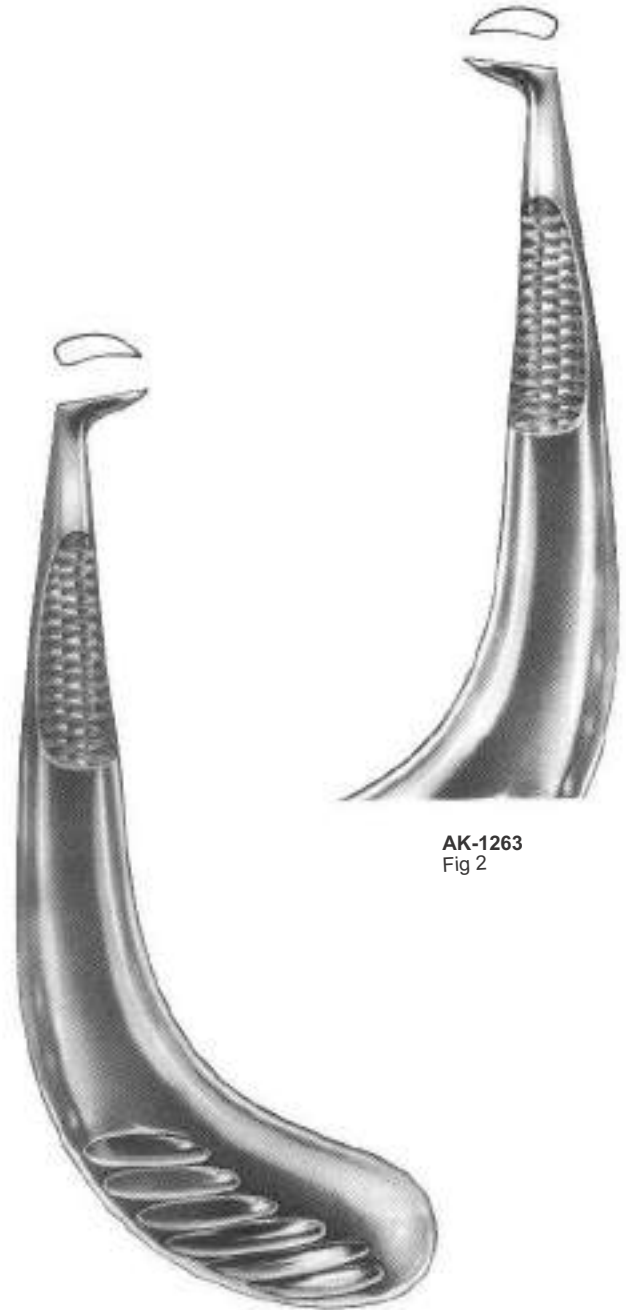

AK-1263
Fig 2

AK-1262
Fig 1

Root Elevators



Meade
AK-1265
MD-5 A



Meade
AK-1266
MD-6 A



Meade
AK-1267
MD-7 A



Meade
AK-1268
MD-8

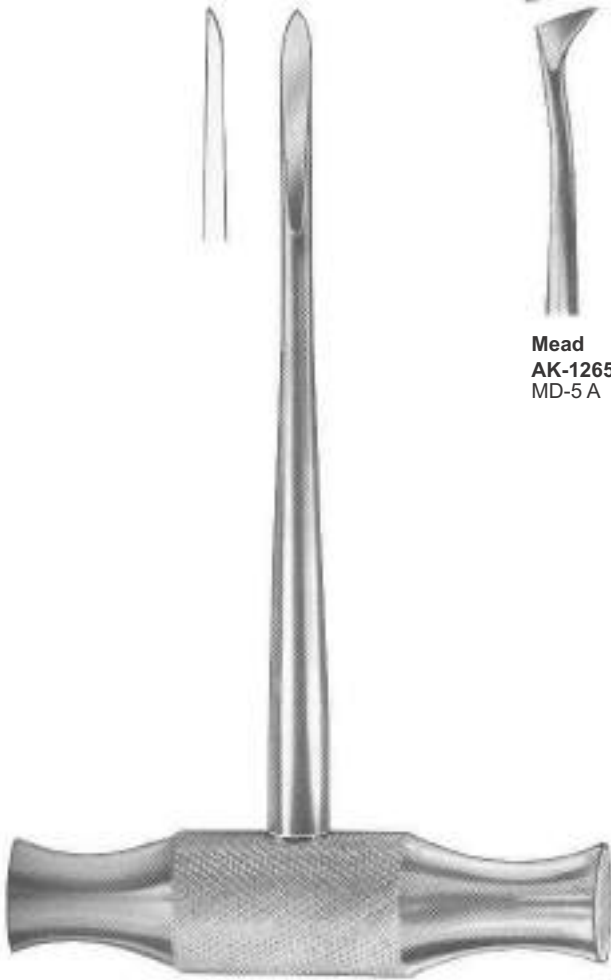

Meade
AK-1264
MD 1

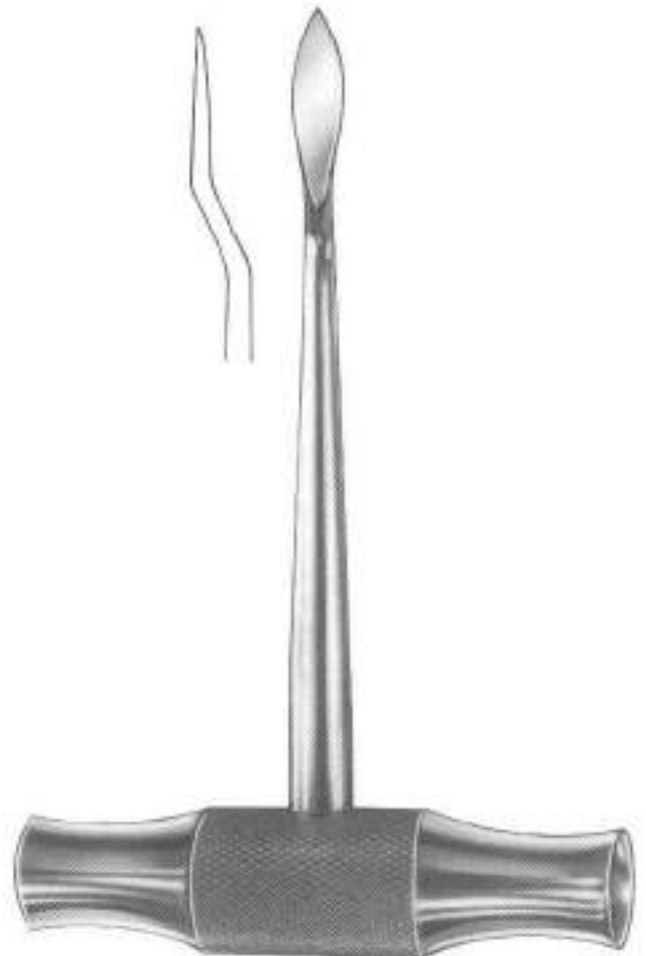

Lecluse
AK-1269

Root Elevators



Chompret
AK-1270
Fig 1



Chompret
AK-1271
Fig 2



Chompret
AK-1272
Fig 3



Chompret
AK-1273
Fig 4



Apical
AK-1274

Root Elevators, Root Tip Elevators



AK-1275
Fig 1



AK-1276
Fig 2



AK-1277
Fig 3



Heidbrink
AK-1278
Fig 1



Heidbrink
AK-1279
Fig 2



Heidbrink
AK-1280
Fig 3

Root Elevators



Winter
AK-1281
Fig 1L



Winter
AK-1282
Fig 1R



Winter
AK-1283
Fig 2L



Winter
AK-1284
Fig 2R



Winter
AK-1285
Fig 11 L



Winter
AK-1286
Fig 11 R



Winter
AK-1287
Fig 12 L



Winter
AK-1288
Fig 12 R



Winter
AK-1289
Fig 14 L



Winter
AK-1290
Fig 14 R



Winter

Root Elevators



Barry
AK-1291
Fig 1



Barry
AK-1292
Fig 2



Barry
AK-1293
Fig 3



Barry
AK-1294
Fig 4



Barry



Barry
AK-1295
Fig 11



Barry
AK-1296
Fig 12



Barry
AK-1297
Fig 17



Barry
AK-1298
Fig 18

Root Elevators



Cryer
AK-1300
Fig 26



Seldin
AK-1301
Fig 27



Cryer
AK-1302
Fig 28



Cryer
AK-1303
Fig 29



Heidbrink
AK-1304
Fig 22



Heidbrink
AK-1305
Fig 23



AK-1299

Root Elevators



**Kopp
AK-1307**
Fig 31



**Kopp
AK-1308**
Fig 32



**Kopp
AK-1309**
Fig 33



**Kopp
AK-1310**
Fig 34



**Kopp
AK-1311**
Fig 35



**Kopp
AK-1312**
Fig 44



AK-1306

Root Elevators



**Heidbrink
1314**
Fig 10



**Winter
1315**
Fig 11



**Winter
AK-1316**
Fig 12



**Barry
AK-1317**
Fig 17



**Barry
AK-1318**
Fig 18



AK-1319
Fig 20



AK-1313

Root Elevators

Root Elevators according to Dr. Sader,
with interchangeable working tips



AK-1321



AK-1320



AK-1322

Filling Instruments

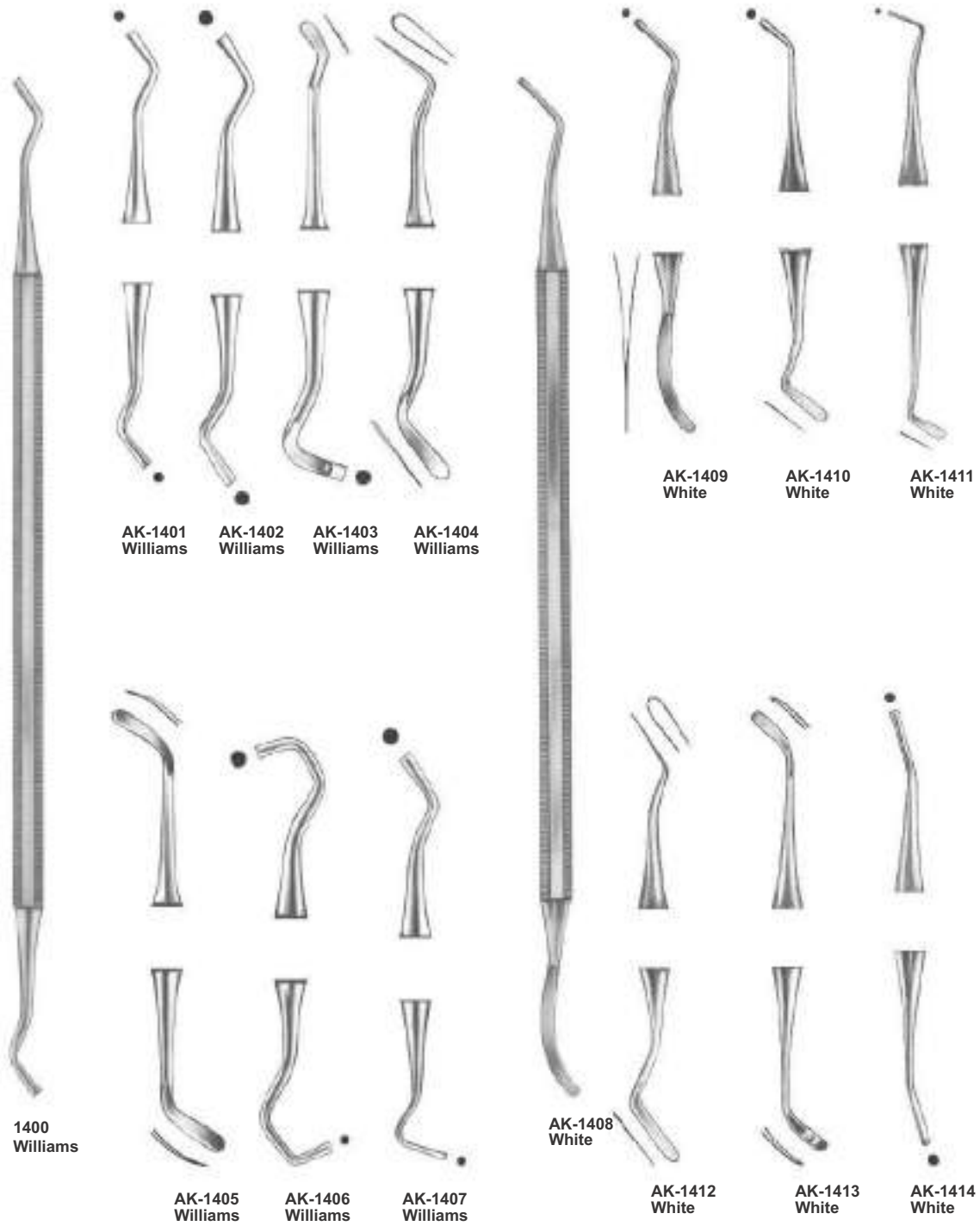

Filling Instruments

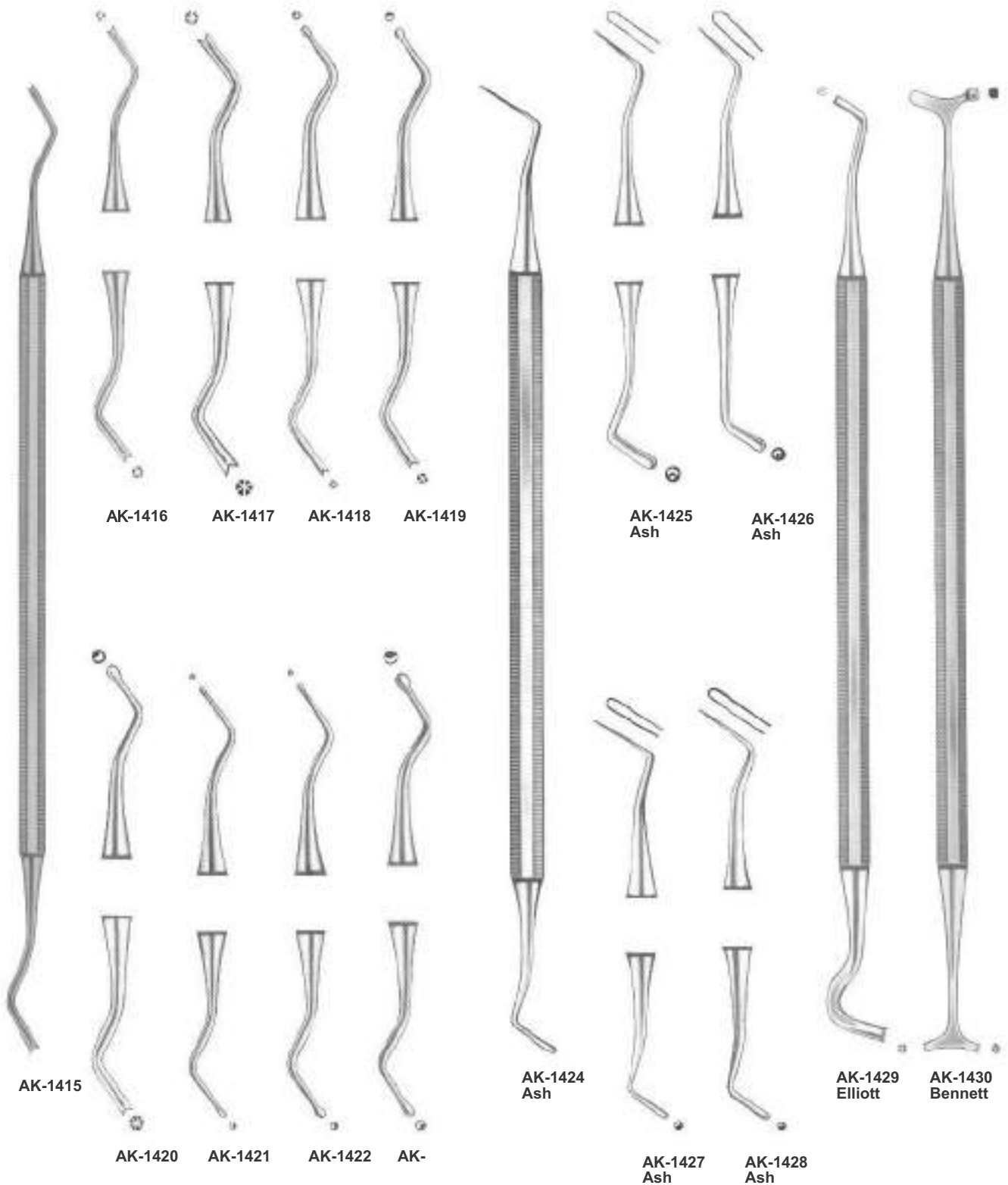

Filling Instruments

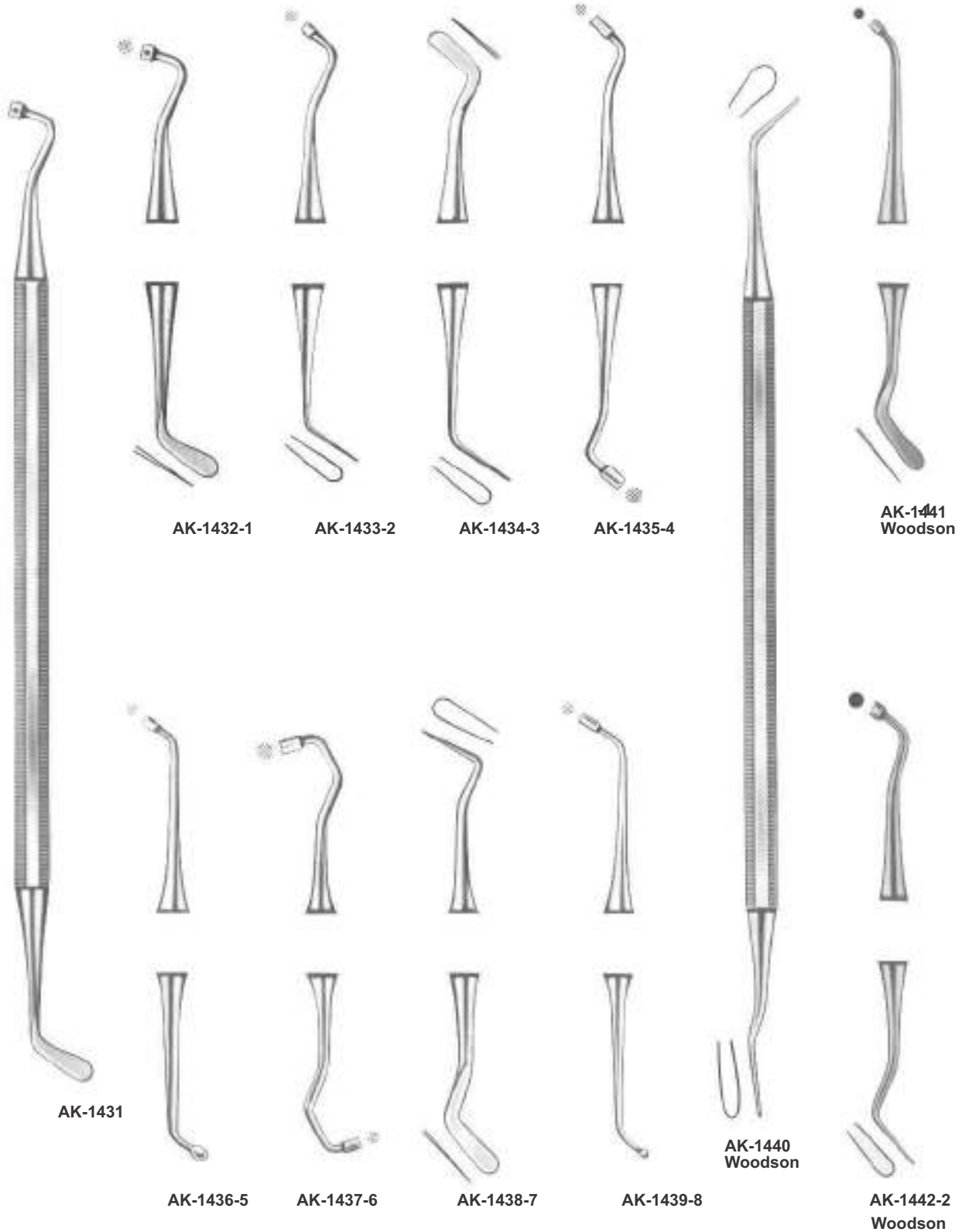

Filling Instruments

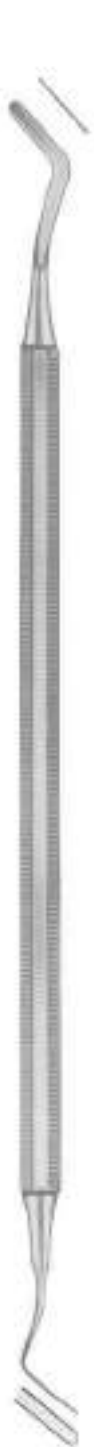

AK-1443
Heidemann
Fig 1

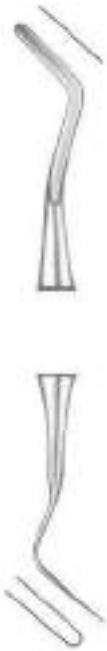

AK-1444
Heidemann
Fig 2



AK-1445
Heidemann
Fig 3



AK-1446



AK-1447
Fig 146



AK-1449
Fig 148



AK-1448
Fig 147



AK-1450
Fig 149



AK-1451
Fig 158

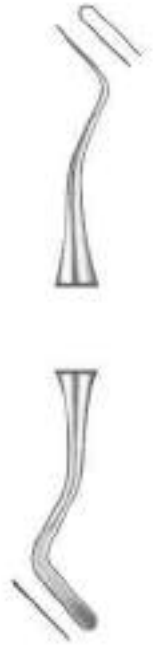

AK-1452
Fig 159

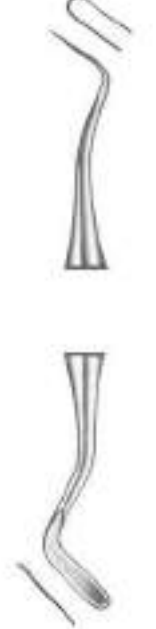

AK-1453
Woodson
Fig 160

dental Currettes and Filling Instruments



AK-1455
Gracey
Fig 1



AK-1456
Gracey
Fig 2



AK-1457
Gracey
Fig 3



AK-1458
Gracey
Fig 4



AK-1459
Gracey
Fig 5



AK-1460
Gracey
Fig 6



AK-1462-1
Fig 18



AK-1463-2
Fig 19



AK-1464-3
Fig 20



AK-1465-4
Fig 22



AK-1466-5
Fig 23



AK-1467-6
Fig 25



AK-1468-7
Fig 26



AK-1469-8
Fig 27



Dental Probes

With Point Set In



AK-1470



AK-1471-1



AK-1472-2



AK-1473-3



AK-1474-4



AK-1475-5



AK-1476-6



AK-1477-7



AK-1478-8



AK-1479-9



AK-1480-10



AK-1481-11



AK-1482-12
Woodson

Polishing Instruments

Burnishers and Pocket Probes Scalers

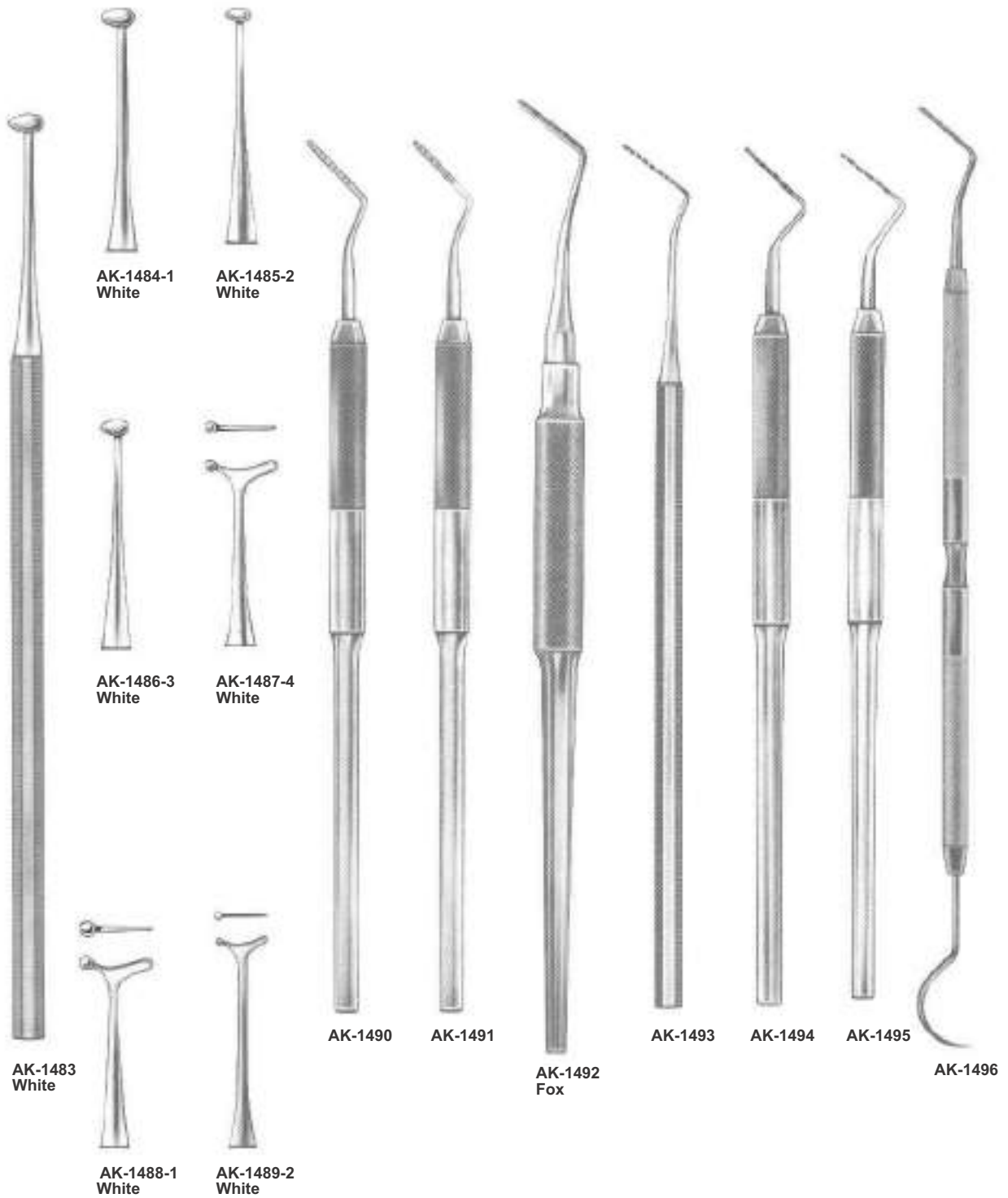

Periodontal Pocket Probes



- New marking process.
- Laser system marking.
- No more paint peeling off.
- Permanent marking.
- Antiglare, low depth marking.
- Maximum tip resistance against breaking.



AK-1497
Fig CP-C



AK-1498
Fig CP-11



AK-1499
Fig CP-12



AK-1500
Fig CP-12S
O.M.S

Periodontal Pocket Probes

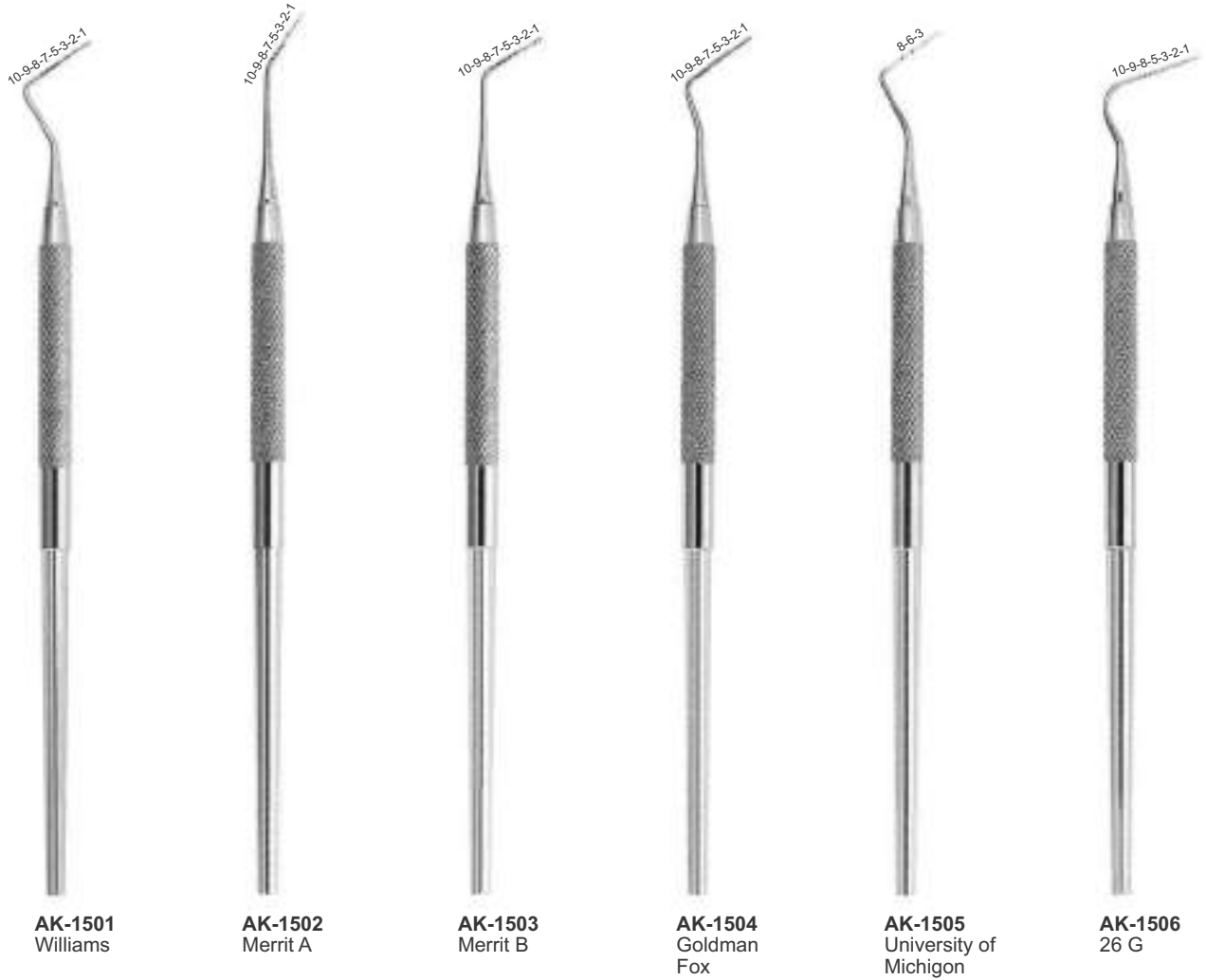

Periodontia Instruments

Files

Chisels

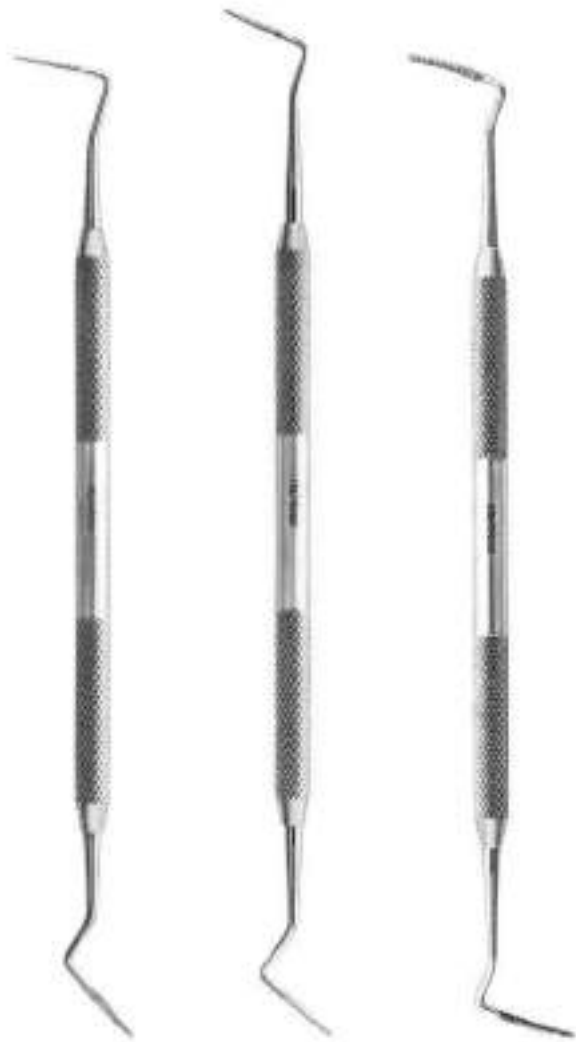

AK-1507
Sugarman
Fig. 1S/2S

AK-1508
Sugarman
Fig. 3S/4S

AK-1509
Schluger
Fig. 9/10



AK-1510
Buck
Fig. 11/12



AK-1511
Ochsenbein
Fig. 3



AK-1512
Ochsenbein
Fig. 4



AK-1513
Rhodes
Back - Action
Fig. 36/37

Files



AK-1514
Sugarman
Fig. 1S/2S

AK-1515
Sugarman
Fig. 3S/4S

AK-1516
Schluger
Fig. 9/10



AK-1517
Buck
Fig. 11/12

Chisels



AK-1518
Ochsenbein
Fig. 3



AK-1519
Ochsenbein
Fig. 4



AK-1520
Rhodes
Back - Action
Fig. 36/37

Periodontia Instruments

Gingivectomy knives



AK-1521
Goldman-Fox
Fig. 7



AK-1522
Goldman-Fox
Fig. 8



AK-1523
Goldman-Fox
Fig. 9



AK-1524
Goldman-Fox
Fig. 11



AK-1525
Buck
Fig. 3/4



AK-1526
Buck
Fig. 5/6

Curettes and Scalers

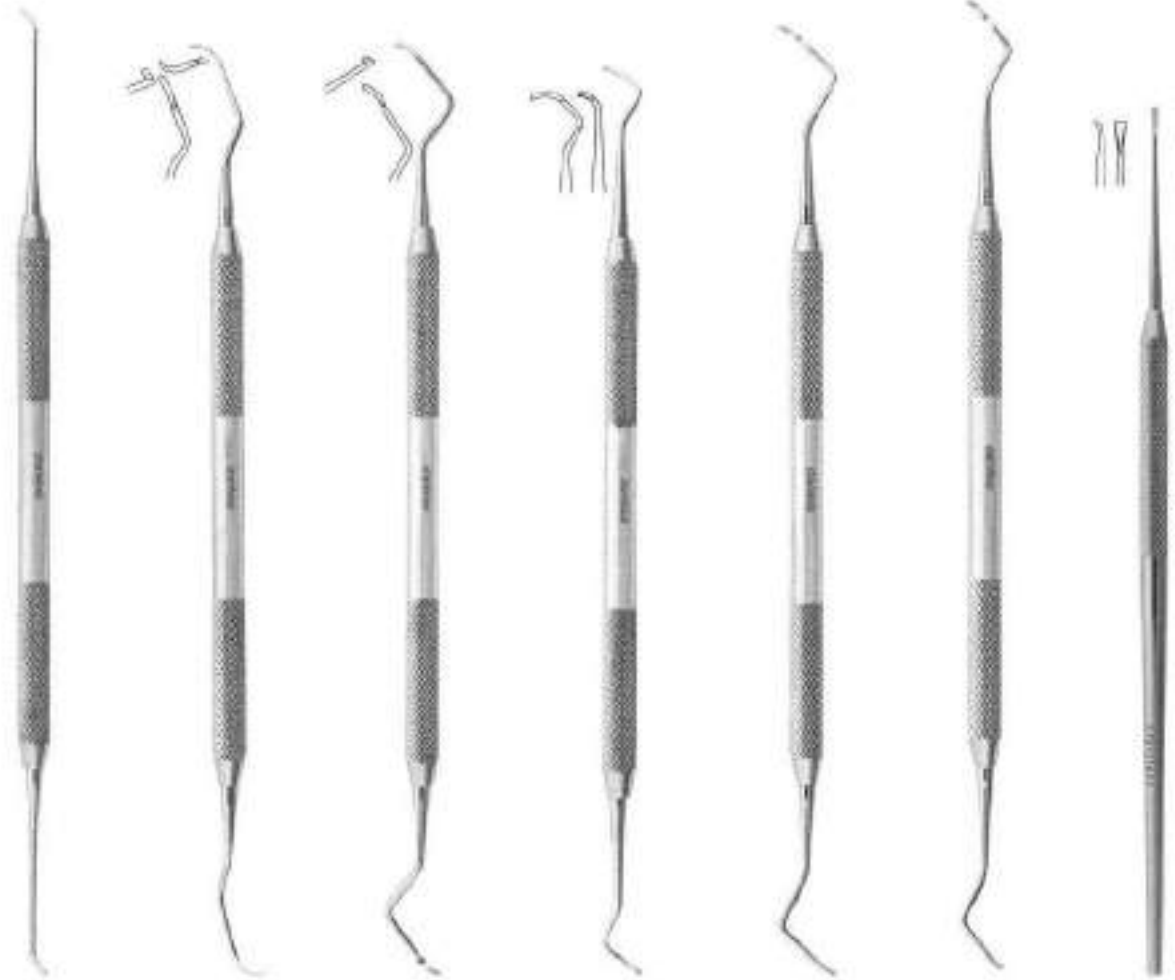

AK-1527
Curette
Fig. HU 1/2

AK-1528
Columbia
Fig. 2R/2L

AK-1529
Columbia
Fig. 4R/4L

AK-1530
Columbia
Fig. 13/14

AK-1531
Fig. 411/412

AK-1532
Fig. 413/414

AK-1533
Zerfing-chisel

Periodontia Instruments

Gingivectomy knives

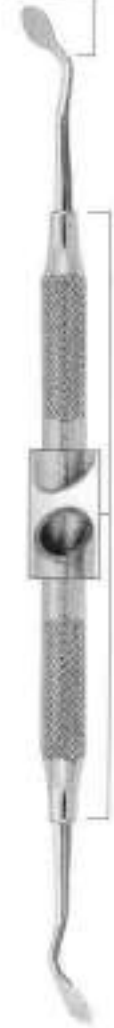

AK-1534
Goldman - Fox
Fig. 7



AK-1535
Goldman - Fox
Fig. 8



AK-1536
Goldman - Fox
Fig. 9



AK-1537
Goldman - Fox
Fig. 11



AK-1538
Buck
Fig. 3/4



AK-1539
Buck
Fig. 5/6

Curettes and Scalers



AK-1540
Curette
Fig. HU 1/2



AK-1541
Columbia
Fig. 2R/2L



AK-1542
Columbia
Fig. 4R/4L



AK-1543
Columbia
Fig. 13/14



AK-1544
Fig. 413/412



AK-1545
Fig. 411/414



AK-1546
Zerfing-chisel

Periodontia Instruments

Bone Chisels and Gouges

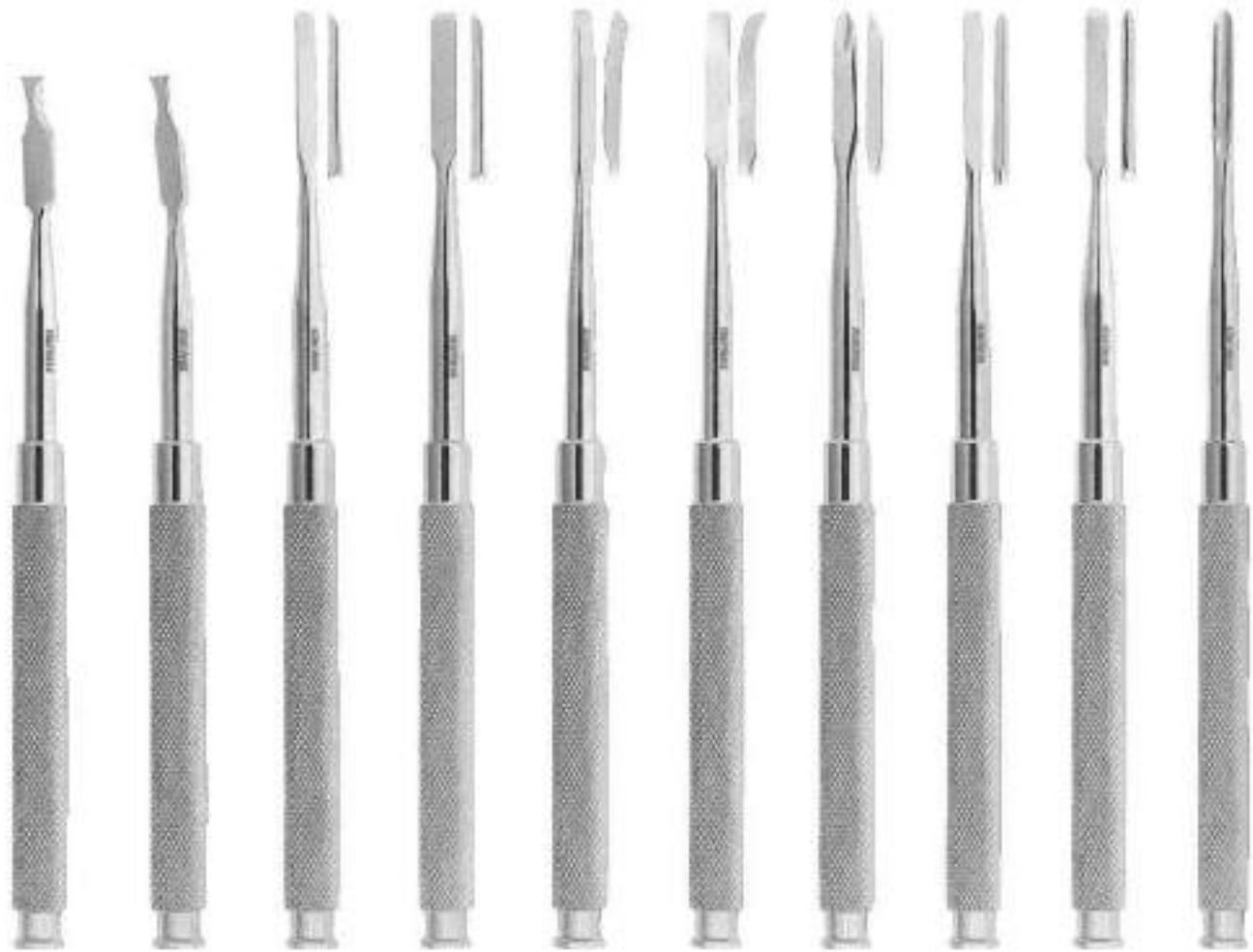

AK-1547
Ochsenbein
Fig. 1

AK-1548
Ochsenbein
Fig. 2

AK-1549
Gardner
Fig. 1

AK-1550
Gardner
Fig. 2

AK-1551
Gardner
Fig. 5

AK-1552
Gardner
Fig. 5R

AK-1553
Gardner
Fig. 6

AK-1554
Wakefield
Fig. 1W

AK-1555
Wakefield
Fig. 2W

AK-1556
Buckley
Fig. 3

Periodontia Instruments and Mallets

Bone Chisels and Gouges

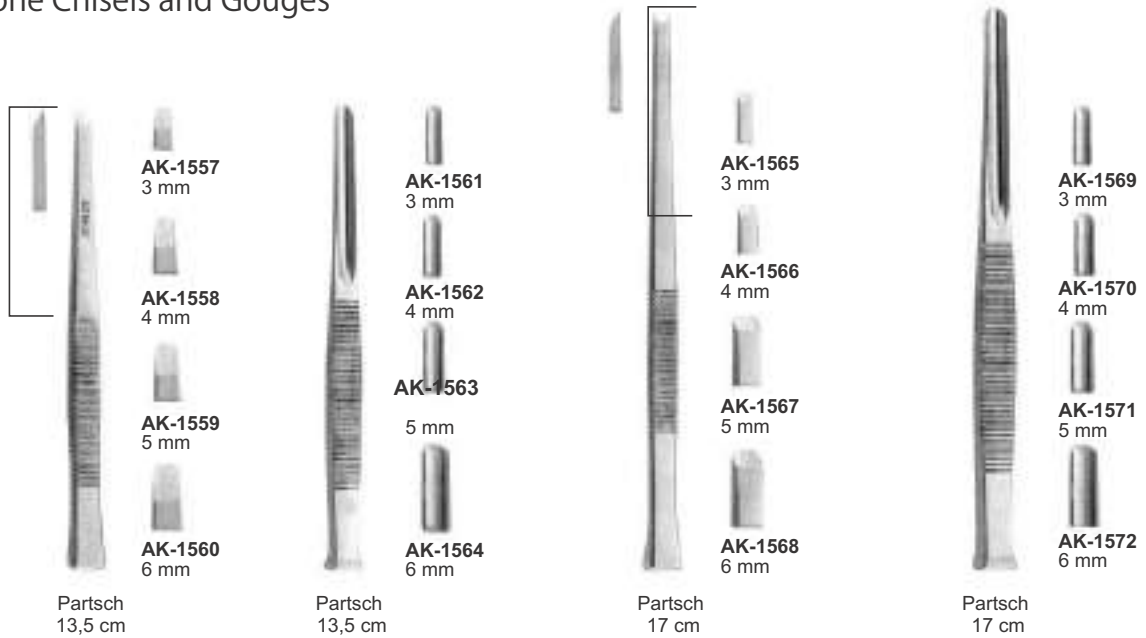

Martelli chirurgici Mallet

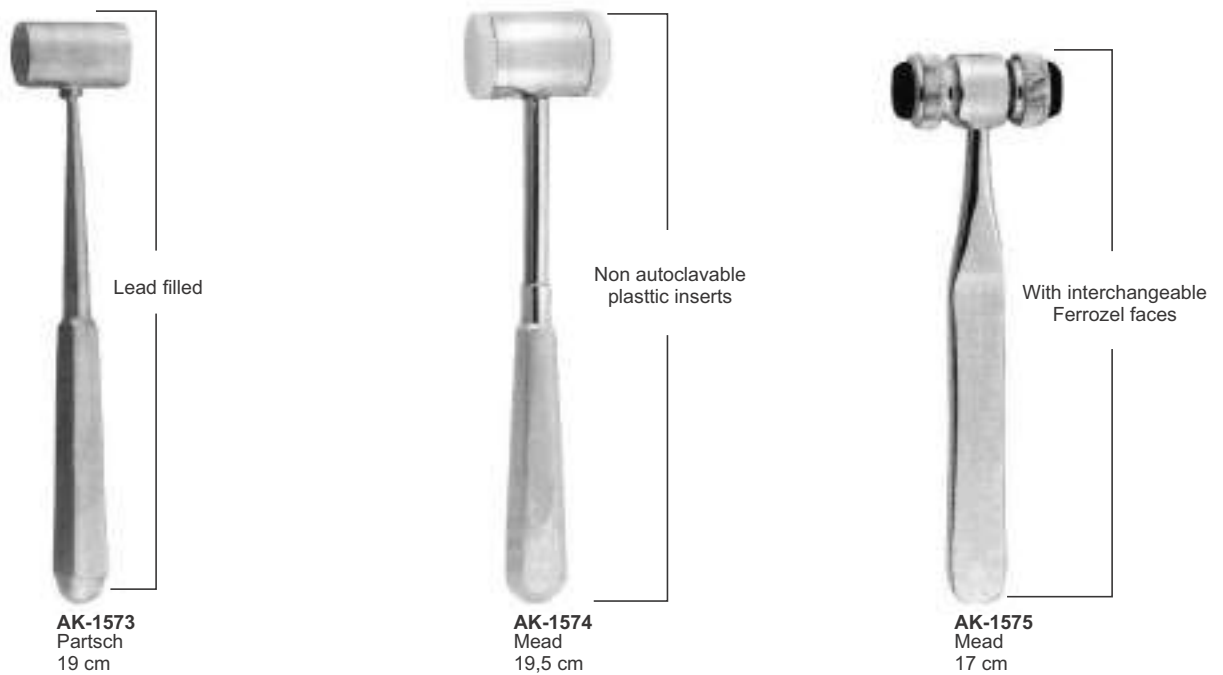

Gracey Curettes

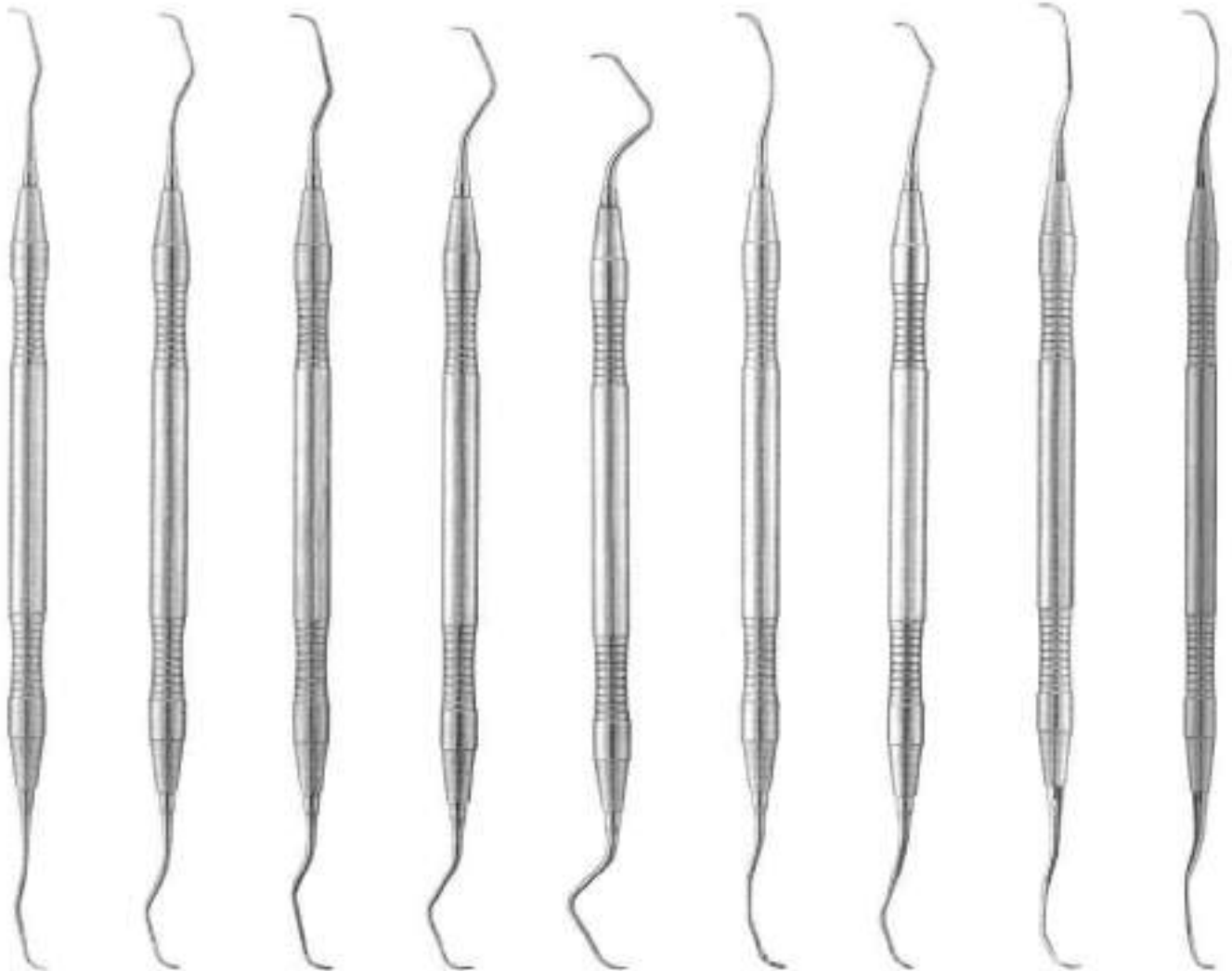
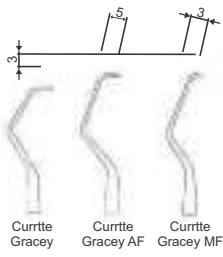

AK-1576
Gracey
Fig. 1/2

AK-1577
Gracey
Fig. 3/4

AK-1578
Gracey
Fig. 5/6

AK-1579
Gracey
Fig. 7/8

AK-1580
Gracey
Fig. 9/10

AK-1581
Gracey
Fig. 11/12

AK-1582
Gracey
Fig. 13/14

AK-1583
Gracey
Mesial Distal
Fig. 11/14

AK-1584
Gracey
Mesial Distal
Fig. 12/13

Gracey Currettes AF Type

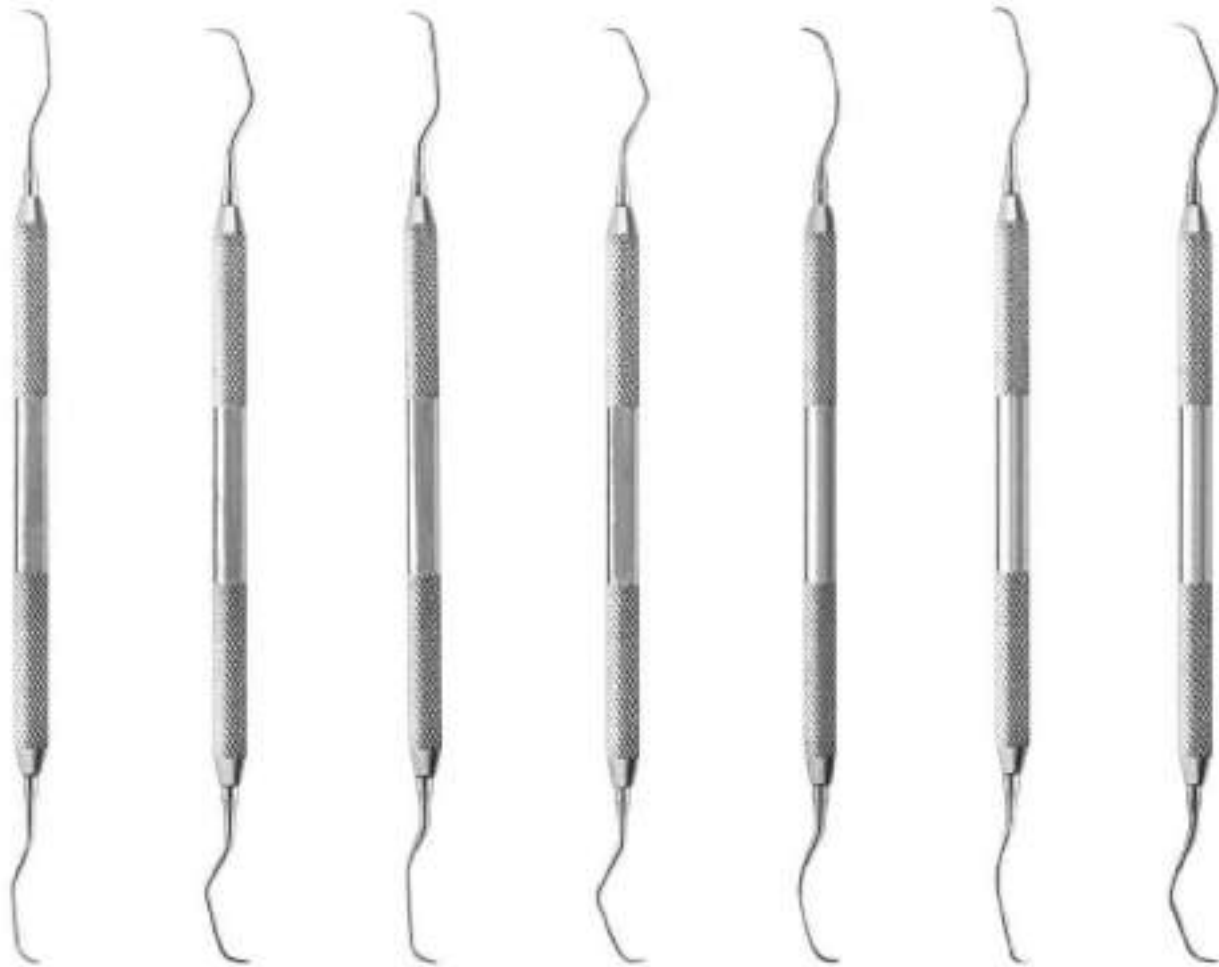
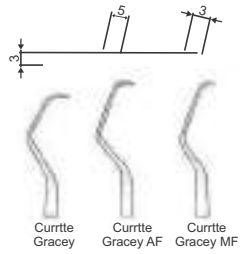

AK-1585
Gracey
AF/type
Fig. 1/2

AK-1586
Gracey
AF/type
Fig. 3/4

AK-1587
Gracey
AF/type
Fig. 5/6

AK-1588
Gracey
AF/type
Fig. 7/8

AK-1589
Gracey
AF/type
Fig. 11/12

AK-1590
Gracey
AF/type
Fig. 13/14

AK-1591
Gracey
AF/type
Fig. 15/16

Gracey Currettes, AF, MF, Tyape



AK-1593
Gracey
AF/type
Fig. 1/2



AK-1594
Gracey
AF/type
Fig. 3/4



AK-1595
Gracey
AF/type
Fig. 5/6



AK-1596
Gracey
AF/type
Fig. 7/8



AK-1597
Gracey
AF/type
Fig. 11/12



AK-1598
Gracey
AF/type
Fig. 13/14



AK-1599
Gracey
AF/type
Fig. 15/16



AK-1600
Gracey
MF/type
Fig. 1/2



AK-1601
Gracey
MF/type
Fig. 3/4



AK-1602
Gracey
MF/type
Fig. 5/6

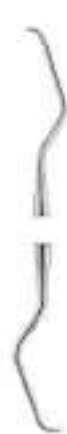

AK-1603
Gracey
MF/type
Fig. 7/8



v1604
Gracey
MF/type
Fig. 11/12



AK-1605
Gracey
MF/type
Fig. 13/14



AK-1606
Gracey
MF/type
Fig. 15/16

AK-1592
Gracey
AF/type

Curettes Gracey AF Type

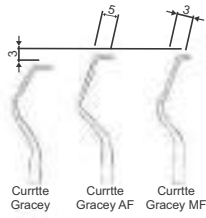

AK-1607
Gracey
MF/type
Fig. 1/2

AK-1608
Gracey
MF/type
Fig. 3/4



AK-1609
Gracey
MF/type
Fig. 5/6



AK-1610
Gracey
MF/type
Fig. 7/8



AK-1611
Gracey
MF/type
Fig. 11/12



AK-1612
Gracey
MF/type
Fig. 13/14



AK-1613
Gracey
MF/type
Fig. 15/16

Curettes and Scalers



AK-1614
Goldman - Fax
Fig. 1



AK-1615
Goldman - Fax
Fig. 2



AK-1617
Goldman - Fax
Fig. 3



AK-1618
Goldman - Fax
Fig. 4



AK-1619
Goldman - Fax
Fig. 21

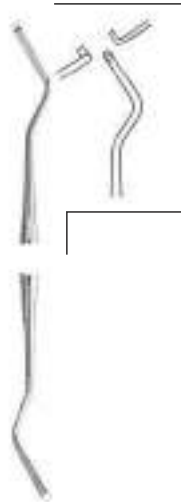

AK-1620
Goldman - Fax
Fig. 5



AK-1621
Mc Call
Fig. 13S/14S

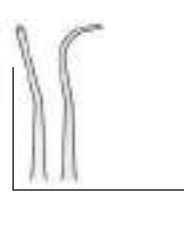

AK-1622
Younger-Good
Fig. 7/8

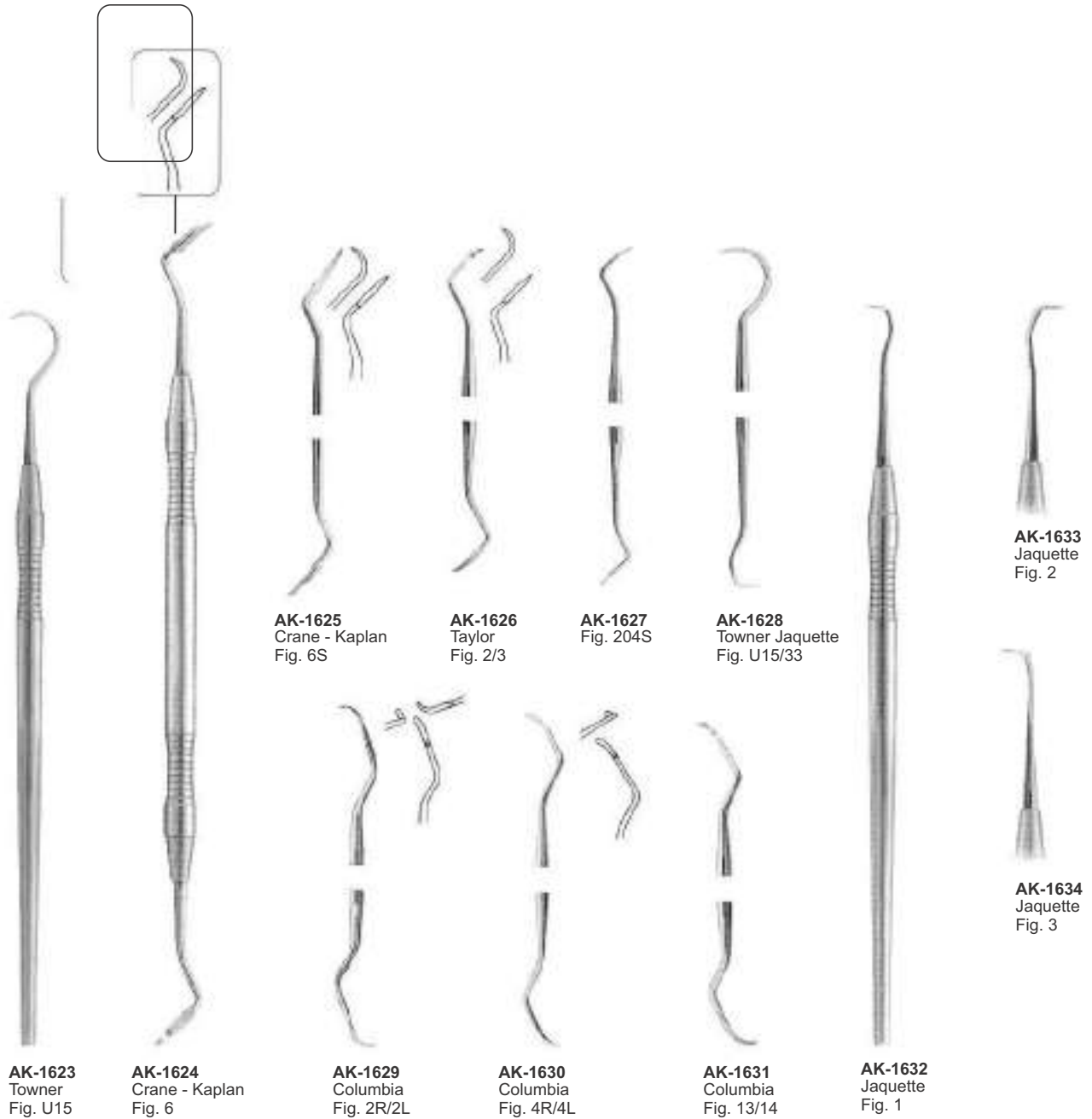

Bone Currettes

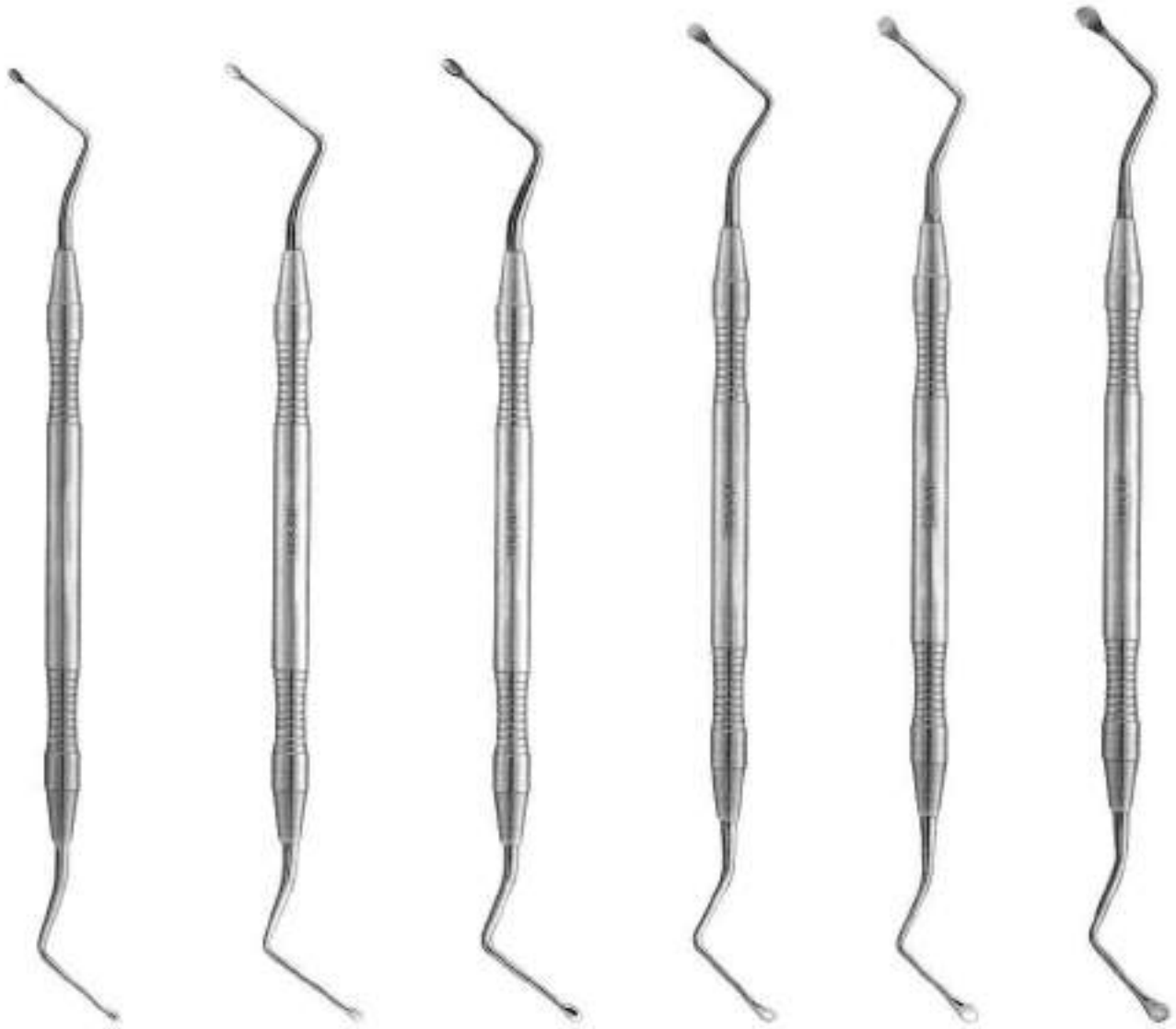

AK-1635
Hemingway
Fig. 1

AK-1636
Hemingway
Fig. 2

AK-1637
Hemingway
Fig. 3

AK-1638
Lucas
Fig. 85

AK-1639
Lucas
Fig. 86

AK-1640
Lucas
Fig. 87

Modelling Instruments

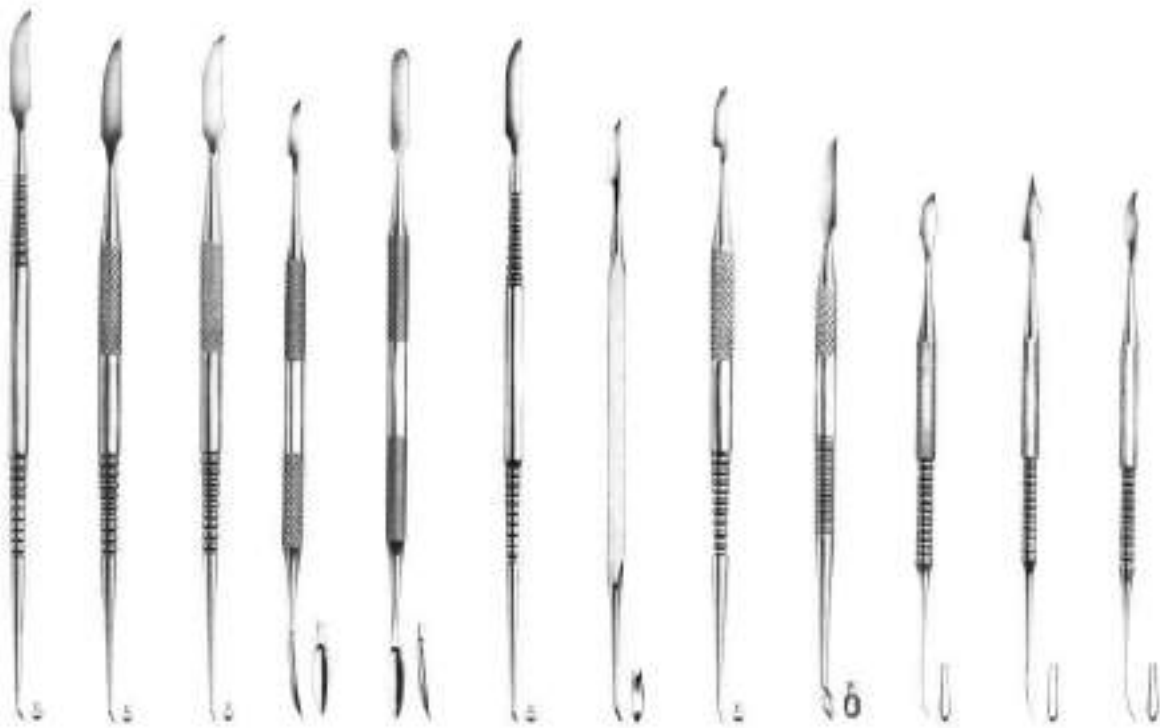

AK-1641 Le Cron AK-1642 Le Cron AK-1643 Le Cron AK-1644 MSY AK-1645 MSY AK-1646 Le Cron AK-1647 Hylin AK-1648 Hylin AK-1649 Hylin AK-1650 Zahle AK-1651 Zahle AK-1652 Zahle

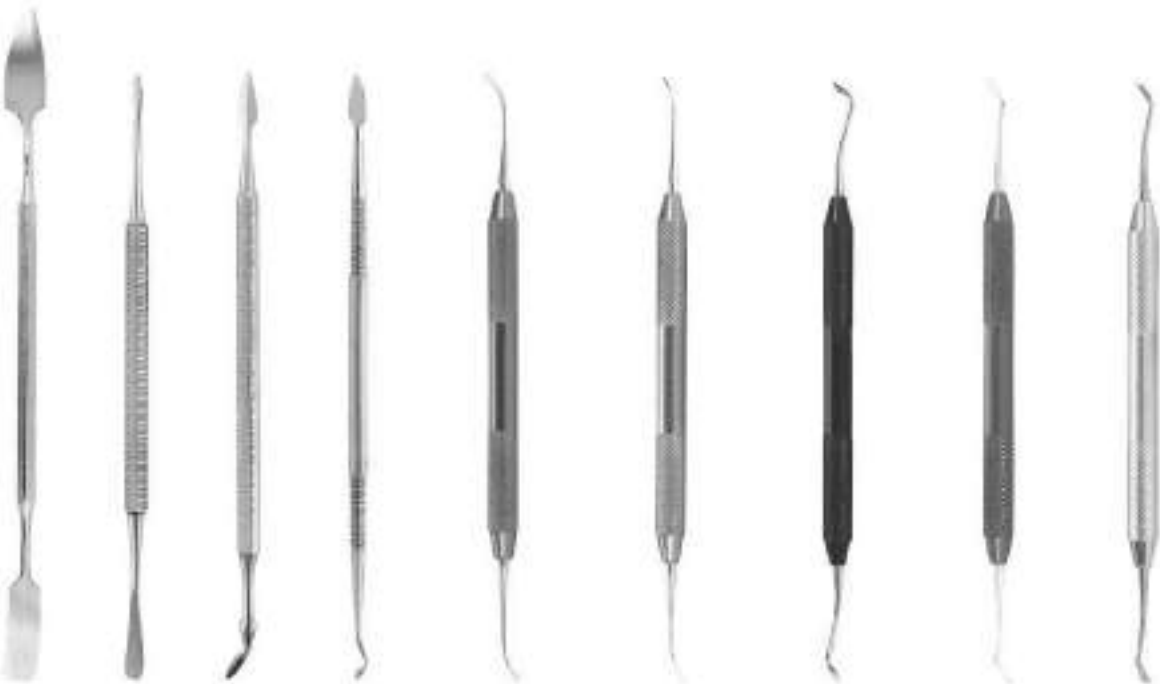

AK-1653 Gritman AK-1654 Beale AK-1655 Roach AK-1656 Vehe AK-1657 P.K. Thomas Fig. 1 AK-1658 P.K. Thomas Fig. 2 AK-1659 P.K. Thomas Fig. 3 AK-1660 P.K. Thomas Fig. 4 AK-1661 P.K. Thomas Fig. 5

Measuring Instruments



AK-1662
Boley



AK-1663
Zuricher
130 mm



AK-1664
Vernier
12 cm



AK-1665
Vernier



AK-1666
Carroll



AK-1667
Castroviejo's
Scleral Marker



AK-1668
Iwanson



AK-1669
Albee

Modelling Instruments



AK-1700
18 cm
7 1/8"



AK-1701
18 cm
7 1/8"



AK-1702
17 cm
6 3/4"
Gritman



AK-1703
17 cm
6 3/4"
Medicon



AK-1704
22 cm
8 3/4"



AK-1705
Antkoviak



AK-1706
Ermert



AK-1707
Ermert

Wax Knives



AK-1708
Fahnenstock
Fig. 1
12,5cm



AK-1709
Fahnenstock
Fig. 2
17cm



AK-1710
Lessmann
Fig. 1
12,5cm



AK-1711
Lessmann
Fig. 2
17cm



AK-1712
Con scodellino
Fig. 1
12,5cm



AK-1713
Con scodellino
Fig. 2
17cm



AK-1714
Fig. 1
17 cm



AK-1715
Gritman
Fig. 2
17 cm



AK-1716
Fig. 3
16 cm



AK-1717
Fig. 4
16 cm

Diagnostic

Explorers



AK-1800
Fig 23



AK-1801
Fig 6



AK-1802
Fig 8



AK-1803
Fig 9



AK-1804
Fig 17



AK-1805
Fig 3
Rein



AK-1806
Fig 23/17



AK-1807
Fig 17

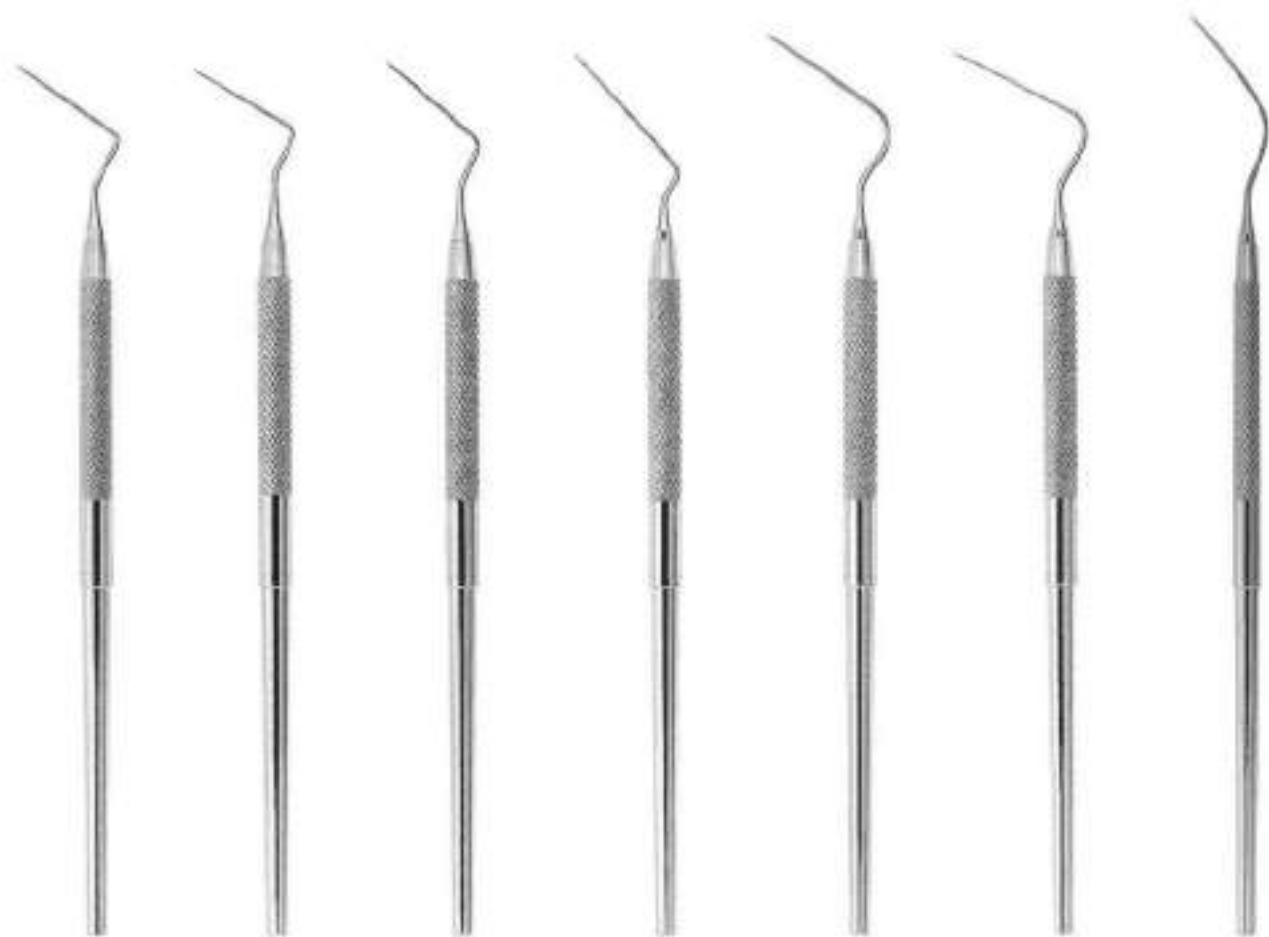

AK-1808
Fig.1
Spreader

AK-1809
Fig.2
Spreader

AK-1810
Fig.3
Spreader

AK-1811
Fig.4
Spreader

AK-1812
Fig.5
Spreader

AK-1813
Fig.6
Spreader

1814
Fig.7
Spreader

Endodontic Instruments

Double-Ended Root Canal
Explorers Plugger/Spreaders

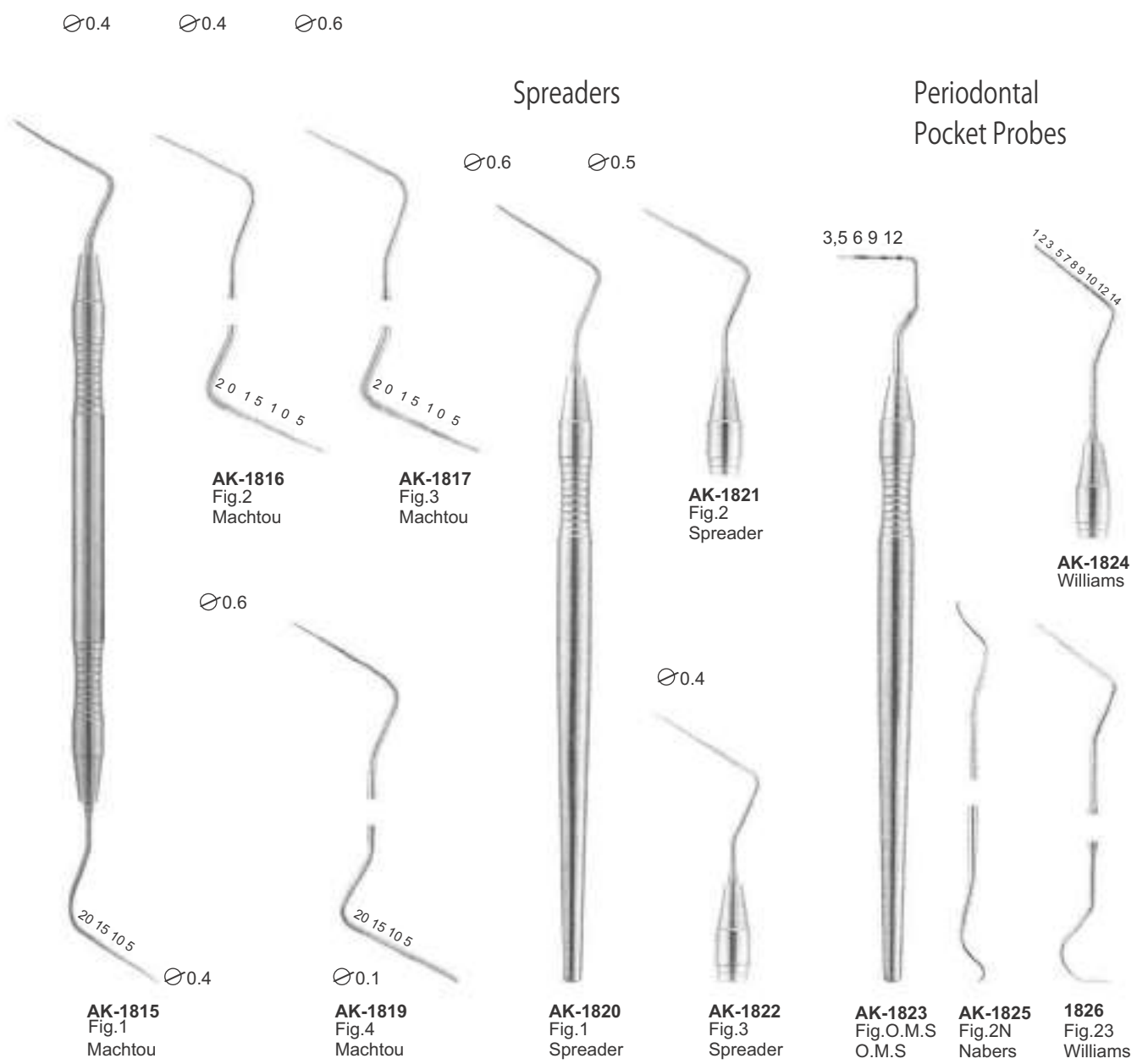

Root-canal pluggers

Ø0.5

Ø0.7

Ø0.9

Ø1.1



AK-1827
Fig.1
Luks

AK-1828
Fig.2
Luks

AK-1829
Fig.3
Luks

AK-1830
Fig.4
Luks

Ø0.5

Ø0.7

Ø0.9

Ø1.1

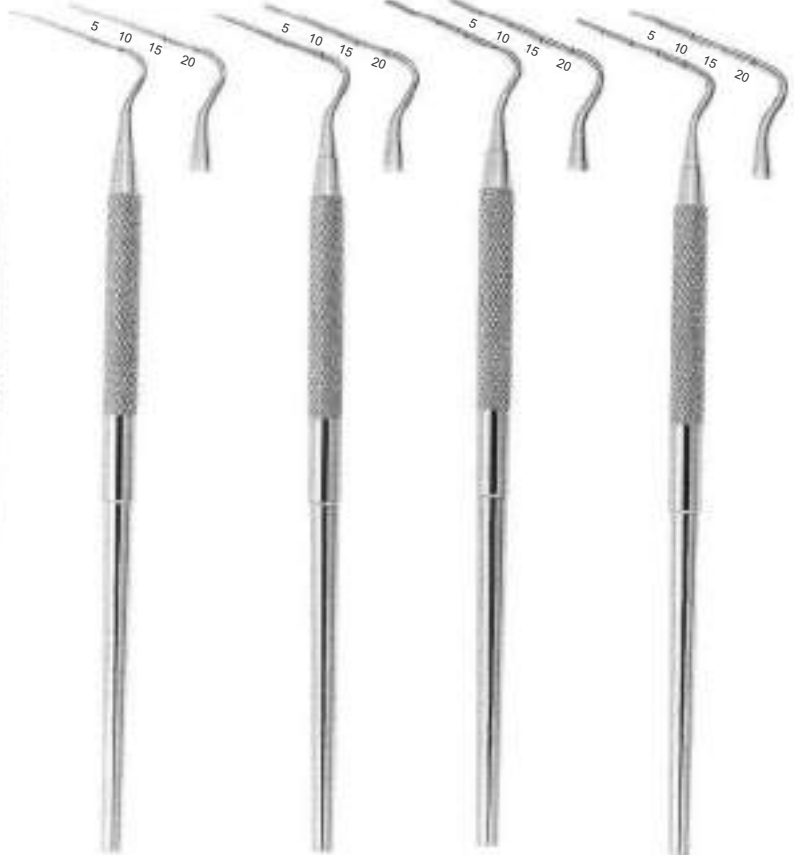

AK-1831
Fig.1
Vertical
condenser

AK-1832
Fig.2
Vertical
condenser

AK-1833
Fig.3
Vertical
condenser

AK-1834
Fig.4
Vertical
condenser

Endodontic set



1835
Measuring Plate

Endodontic Instruments

Root-canal pluggers

Optimum Flexibility
Very Fine Points

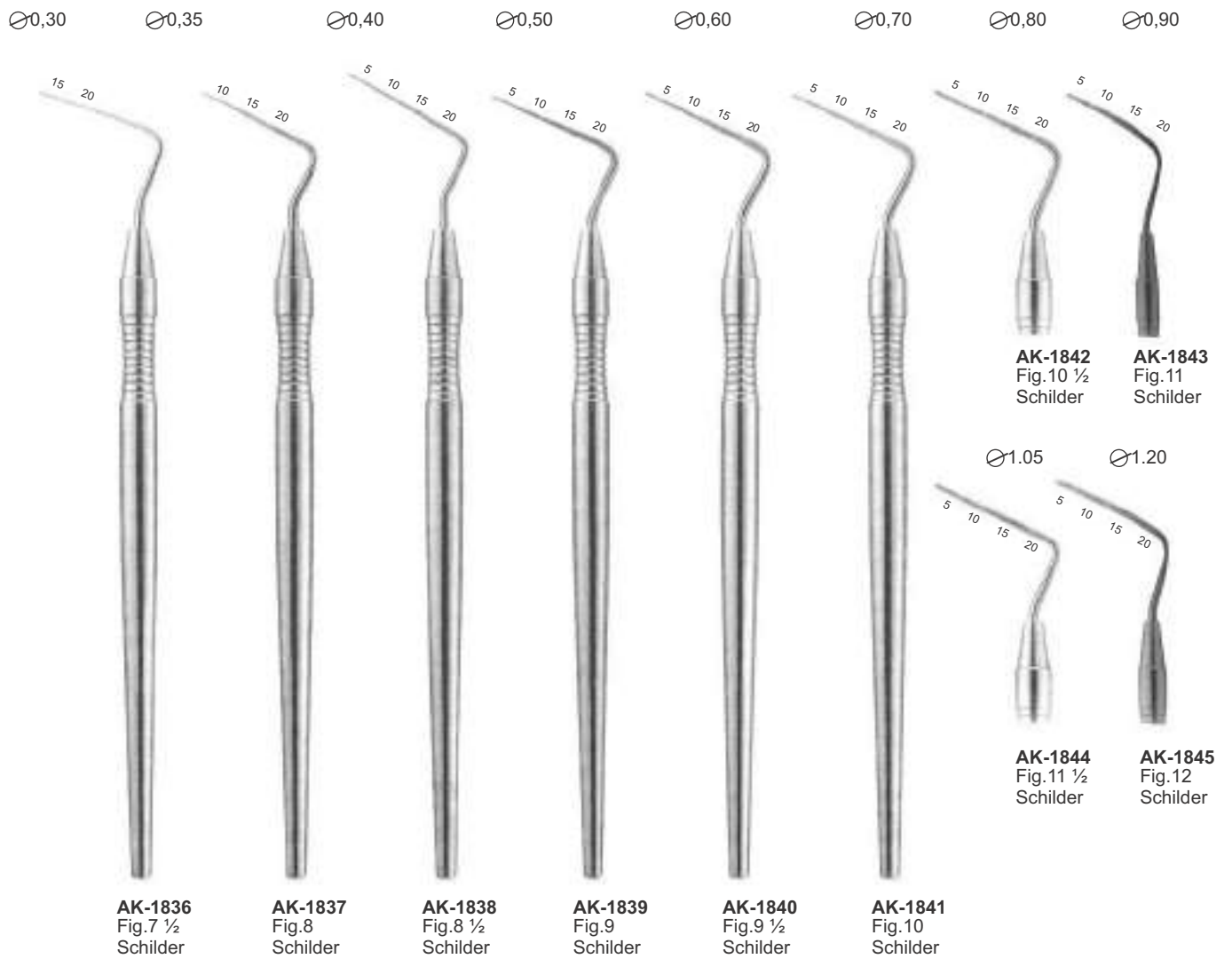

Root-canal explorers



AK-1846
Fig.6/1

AK-1847
Fig.6/17

Root-canal excavators

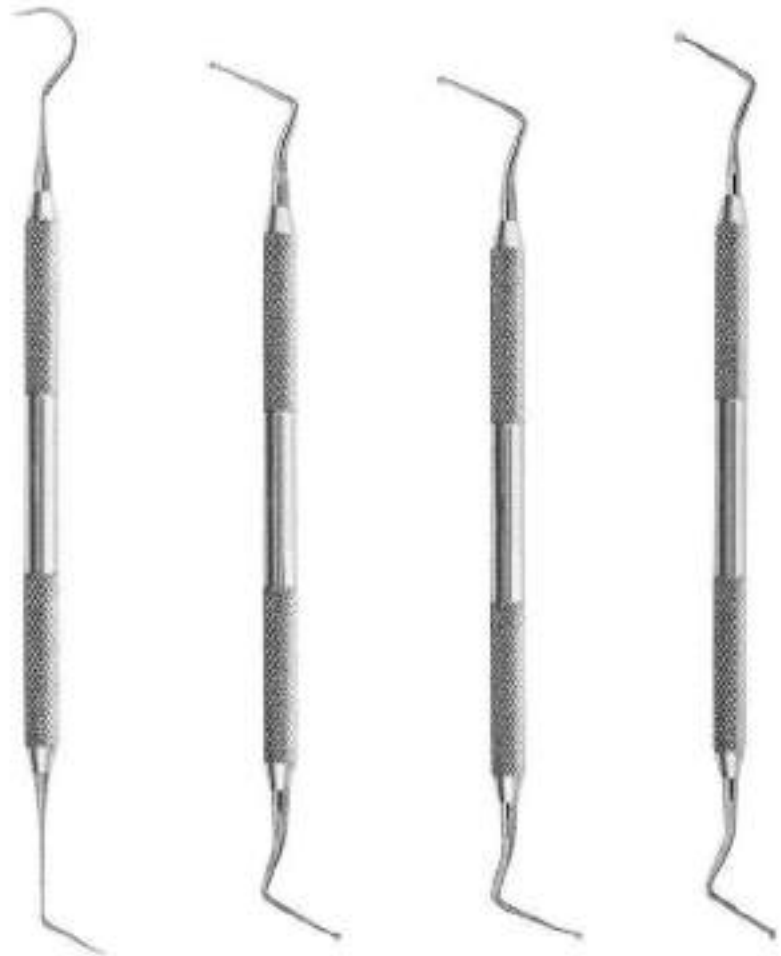

AK-1848
Fig.6/23

AK-1849
Fig.31L

AK-1850
Fig.32L

1851
Fig.33L

Excavators

1 mm



AK-1852
Fig 5

1.2 mm



AK-1853
Fig 14

1 mm



AK-1854
Fig 17

1.2 mm



AK-1855
Fig 18

1.6 mm



AK-1856
Fig 19

2 mm



1857
Fig 20

1 mm



AK-1858
ASH
Fig.243

1,4 mm



AK-1859
ASH
Fig.G2

0,8 mm



AK-1860
Fig.1

0,8 mm



AK-1861
Fig.2

1 mm



AK-1862
Fig.11

1 mm



AK-1863
Fig.12

1,2 mm



1864
Fig.21

1,2 mm



AK-1865
Fig.22

1,6 mm



AK-1866
Fig.31

1,6 mm



AK-1867
Fig.32

2 mm



AK-1868
Fig.41

2 mm



1869
Fig.42

Handles for Mouth Mirrors and Mouth Mirrors

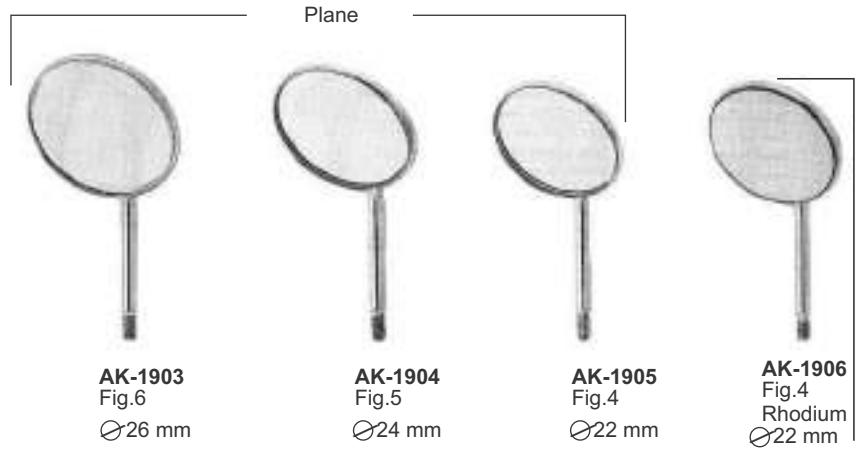

Front surface mouth mirrors

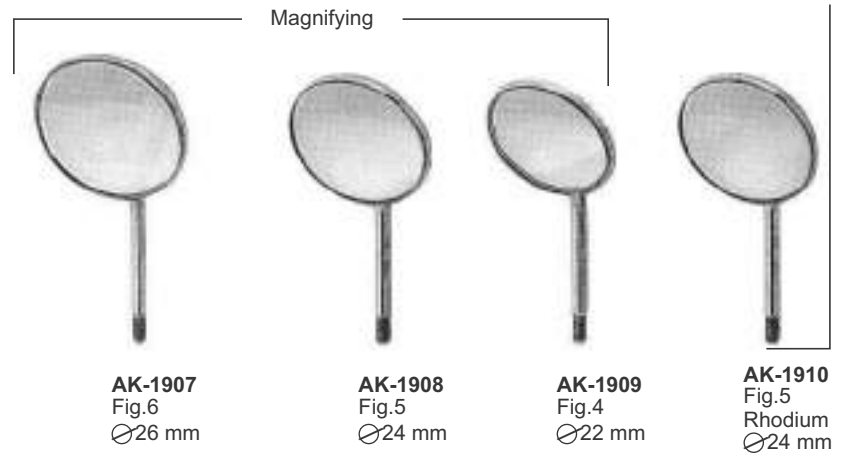
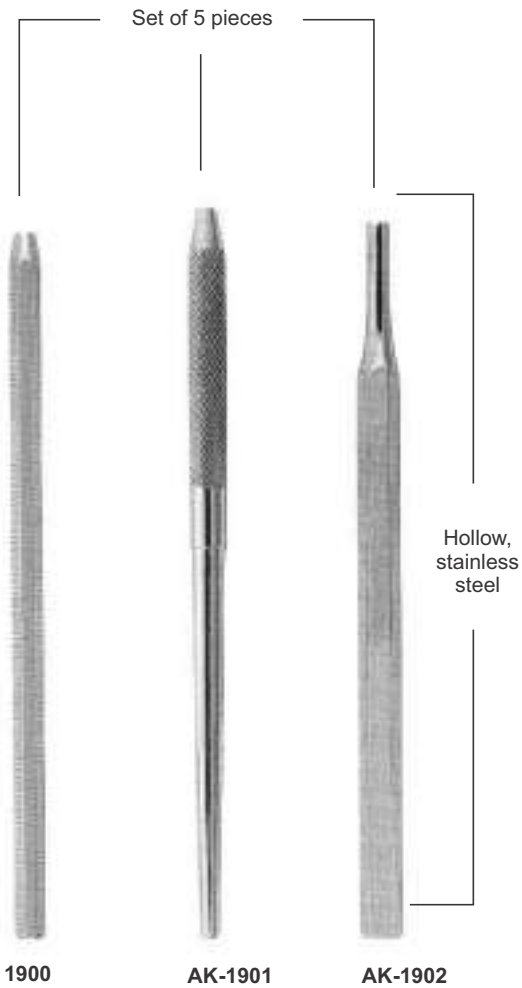

Handles for Mouth Mirrors and Mouth Mirrors



AK-1911



AK-1912



AK-1913



AK-1914



AK-1915



AK-1916
Parallelometer
mouth mirror

AK-1917
Parallelometer
mouth mirror
+ handle
code 2101

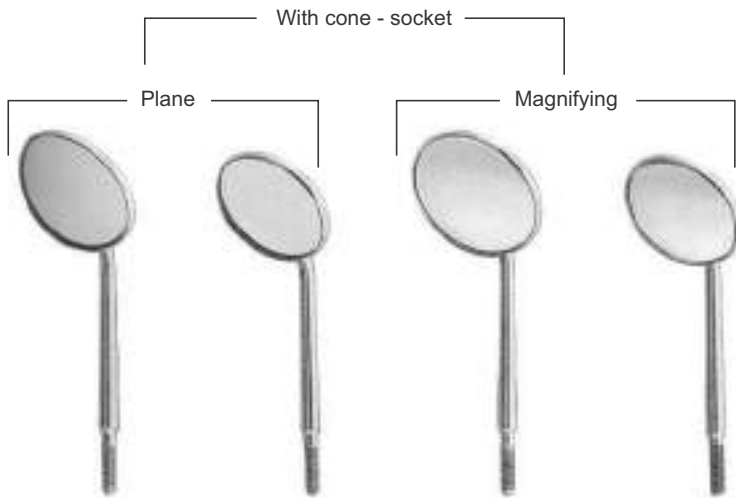

AK-1918
Fig.5
Ø24 mm

AK-1919
Fig.4
Ø22 mm

AK-1920
Fig.5
Ø24 mm

AK-1921
Fig.4
Ø22 mm



AK-1922
Cone - socket



AK-1923
Cone - socket



AK-1924
Cone - socket

Cement Spatulas



AK-2000



AK-2001



AK-2002



AK-2003

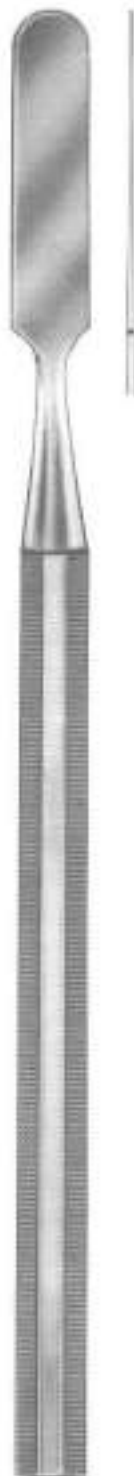

AK-2004



AK-2005



AK-2006



AK-2007

Cement Spatulas



AK-2008

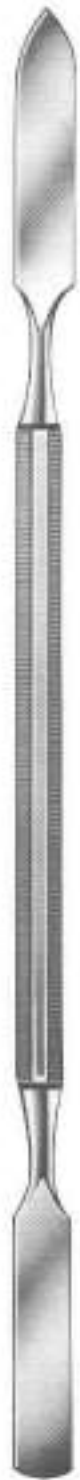

AK-2009



AK-2010



AK-2011



AK-2012



AK-2013



AK-2014



Spatulas for Plaster and Alginate



Spatulas for Plaster and Alginate



AK-2126
Fig. 7
19.5 cm



AK-2127
Fig. 8
20 cm

AK-2128
Fig. 9
22.5 cm

Needle Holders



AK-2200
Mayo-Hegar
16 cm



AK-2201
Mayo-Hegar TC
16 cm



AK-2202
Mayo-Hegar
18 cm



AK-2203
Mayo-Hegar TC
18 cm



AK-2204
Mini-Ryder
18 cm



AK-2205
Mini-Ryder
15 cm

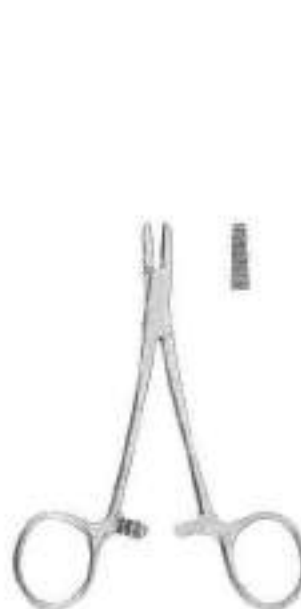

AK-2206
Derf
12 cm



AK-2207
Hegar-Baumgarther
14 cm

Needle Holders



AK-2208
Crile-Wood
15 cm



AK-2209
Crile-Wood TC
15 cm



AK-2210
Adson
17.5 cm



AK-2211
Olsen-Hegar
14 cm



AK-2212
Baumgarther
14.5 cm



AK-2213
Gillies
16 cm



AK-2214
Gillies
16 cm



AK-2215
Hegar-Baumgarther
14 cm

Needle Holders



AK-2216
Toennis
18 cm



AK-2217
Toennis
18 cm



AK-2218
Lichtenberg
17 cm



AK-2219
Lichtenberg
17 cm



AK-2220
Eiselberg-Mathieu
19.5 cm



AK-2221
Boynton
12 cm



AK-2222
Arruga
16 cm



AK-2223
Boynton
12 cm



AK-2224
Arruga
16 cm

Needle Holders



AK-2225
Castroviejo
14 cm



AK-2226
Castroviejo
14 cm



AK-2227
Castroviejo
14/60 cm



AK-2228
Castroviejo
18 cm



AK-2229
Castroviejo
18 cm



AK-2230
Castroviejo
14 cm



AK-2231
Castroviejo
14 cm



AK-2232
Castroviejo
14/60 cm



AK-2233
Castroviejo
18 cm



AK-2234
Castroviejo
18 cm

Needle Holders



AK-2235
Mathieu
14 cm



AK-2236
Mathieu
14 cm



AK-2237
Mathieu
14 cm



AK-2238
Mathieu
14 cm



AK-2239
Mathieu
17 cm



AK-2240
Mathieu
17 cm



AK-2241
Mathieu
14 cm



AK-2242
Micro-Barraquer
18 cm

Ile Holders & Stainless Steel Saliva Ejectors



The tips have tungsten carbide inserts for better handling.



AK-2243
Mathieu
17 cm



AK-2244
Mathieu
17 cm



AK-2245
Micro-Barraquer
14 cm



AK-2246
Castroviejo
13 cm



AK-2247
Castroviejo-Barraquer
13 cm



AK-2248
Castroviejo
13 cm



AK-2249
Castroviejo
13 cm



AK-2251
18.03mm,cm



AK-2252
18.04mm,cm



AK-2253
18.05mm,cm



AK-2254
ig. 12FR
Fraizer
15.04mm,cm



AK-2255
ig. 10FR
Fraizer
15.03,3mm,cm



2256
Fig. 8FR
Fraizer
15.02,7mm,cm



AK-2250
Fig. 6FR
Fraizer
15.02mm,cm

Water Syringes



AK-2300
Water Syringe complete with
1 cannula (Lure-Lock)



AK-2301
Water Syringe complete with
1 cannula (Lure-Lock)



AK-2302
Metal water syringe, self-filling,
with 1 cannula (Lure-Lock)



AK-2303
Sparrel Barrel with
plunger suitable for
syringes



AK-2304
Cannula, only, with
Luer-Lock connector
suitable for syringes

Syringes, Rulers, Band Adaptor, Position Gauge



AK-2305
Aspirating Syringe



AK-2306
Position Gauge



AK-2307
Breech Loading Syringe



AK-2308
Aspirating & Breech Syringe



AK-2309
Band Adaptor



AK-2310
Endo Finger Ruler
With Adjustable Slide



AK-2311
Aspirating Syringe

Dental Syringes



AK-2312



AK- 2313



AK-2314



AK-2315 1,8 ml
AK-2316 2,2 ml

Cartridge Syringe complete
With 2 tips and without needles



AK-2317
Tip Only, short



AK-2318
Tip Only, long



AK-2319



AK-2320



AK-2321

-Ligamental Syringes & Dental Syringes



AK-2322
Cork screw tip



AK-2323
Cork screw tip



AK-2324
Folding type, cork
screw tip



AK-2325
Folding type, cork
screw tip



AK-2326



AK-2327
Cork screw tip



AK-2328
Spare cap with
metric thread



AK-2329
With Whitworth
thread



AK-2330
Autoclavable Plastic Protection sleeve



AK-2331
Brass syringe with stainless steel moving parts



AK-2332
Brass syringe with stainless
steel moving parts

Dental Tweezers



AK-2400
College
15 cm



smooth



AK-2401
College
15 cm



serrated



AK-2402
College
15 cm



smooth



AK-2403
College
15 cm



serrated



AK-2404
College
15 cm



smooth



AK-2405
College
15 cm



serrated



AK-2406
College
15 cm



smooth



AK-2407
College
15 cm



serrated

Dental Tweezers

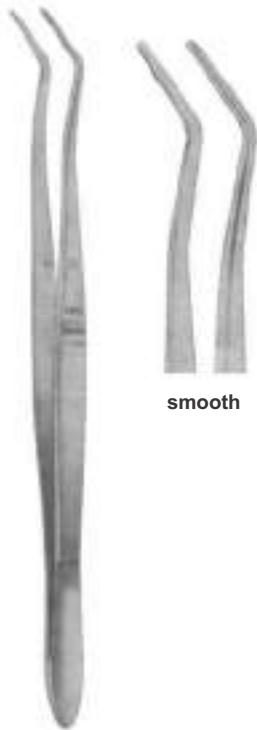

smooth

AK-2408
Meriam
16 cm

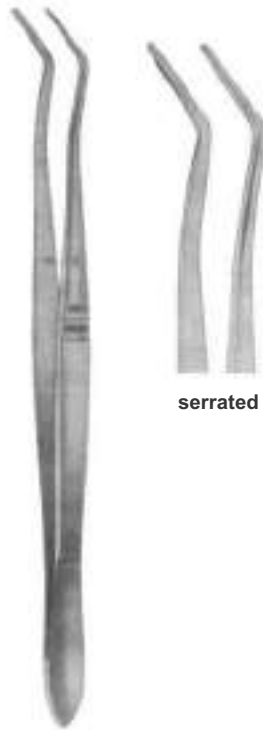

serrated

AK-2409
Meriam
16 cm

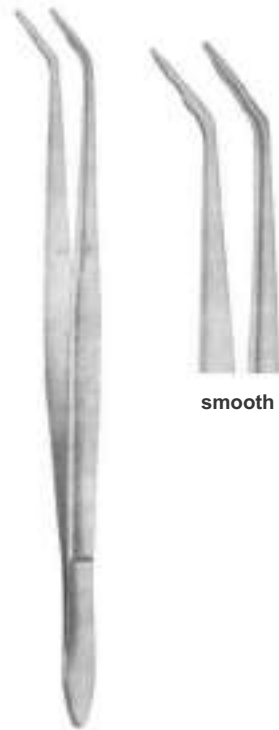

smooth

AK-2410
Meriam
16 cm

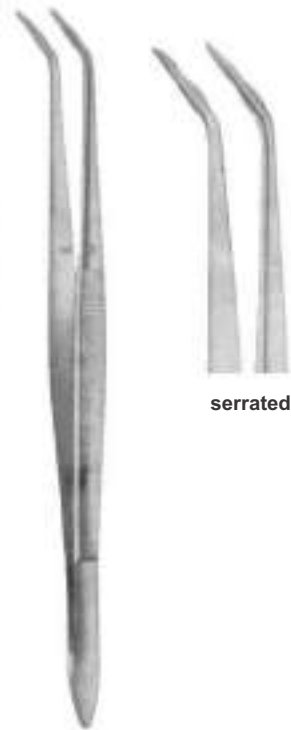

serrated

AK-2411
Meriam
16 cm

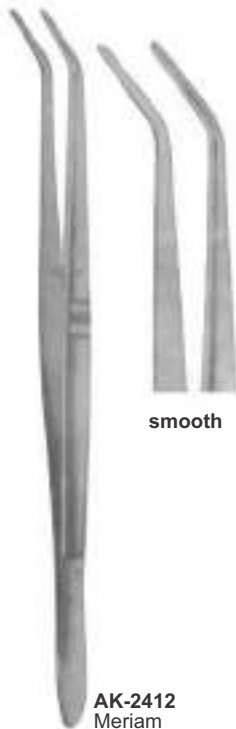

smooth

AK-2412
Meriam
16 cm

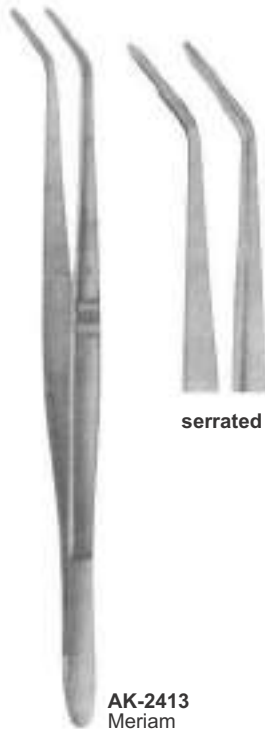

serrated

AK-2413
Meriam
16 cm

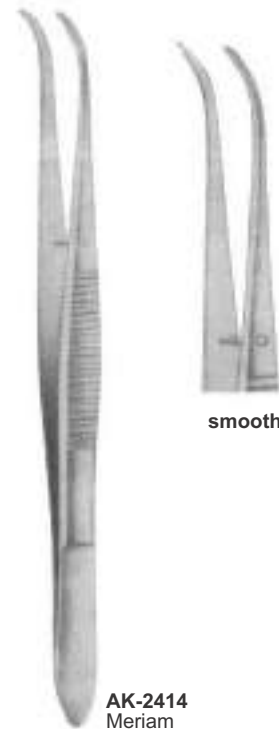

smooth

AK-2414
Meriam
16 cm

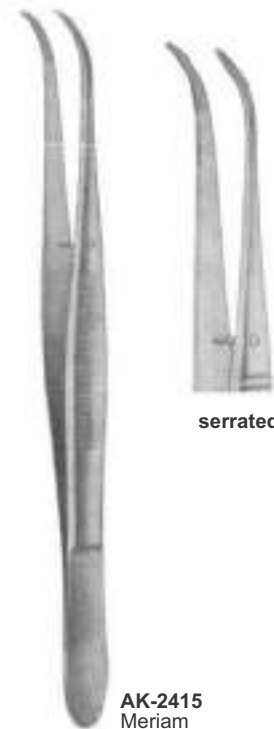

serrated

AK-2415
Meriam
16 cm

Dental Tweezers

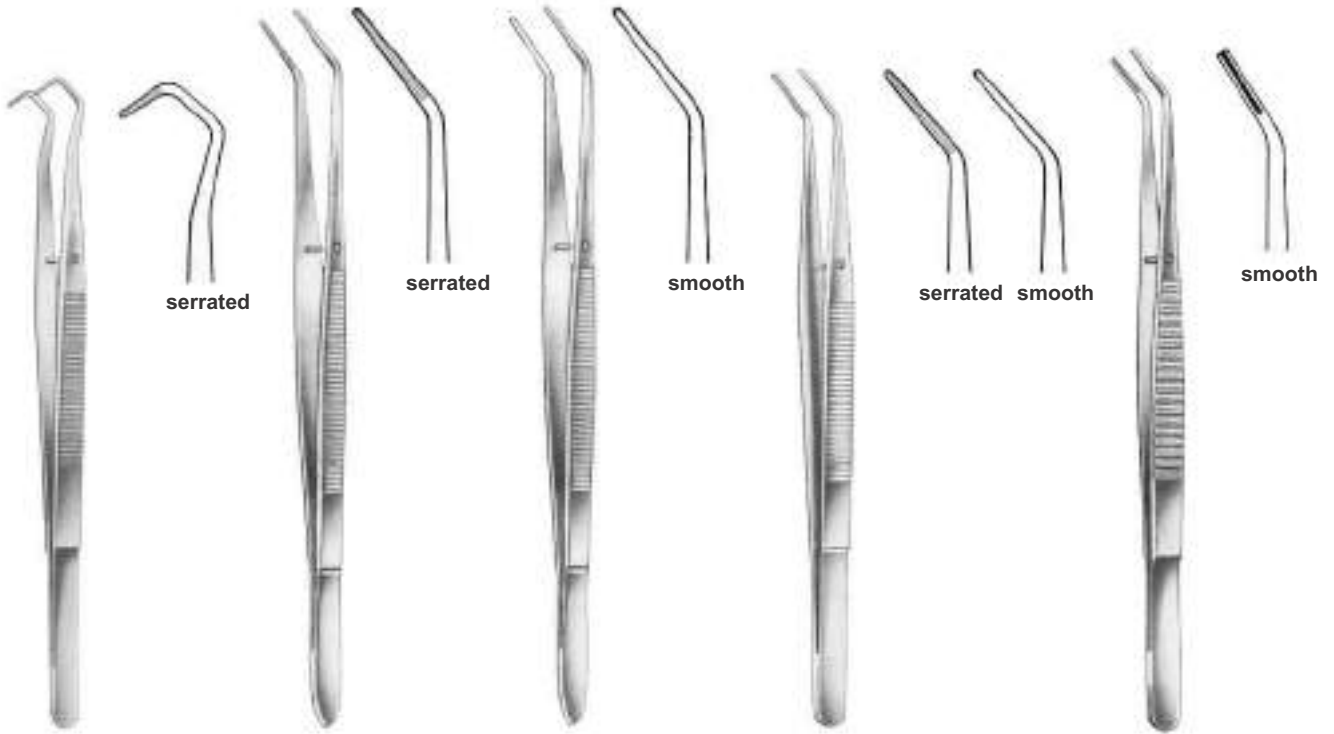

AK-2416
College
14.5 cm, 5³/₄"

AK-2417
Flagg
16 cm, 6¹/₄"

AK-2418
Flagg
16 cm, 6¹/₄"

AK-2419
Landgraf
15 cm, 6"

AK-2420
15.5 cm, 6¹/₈"

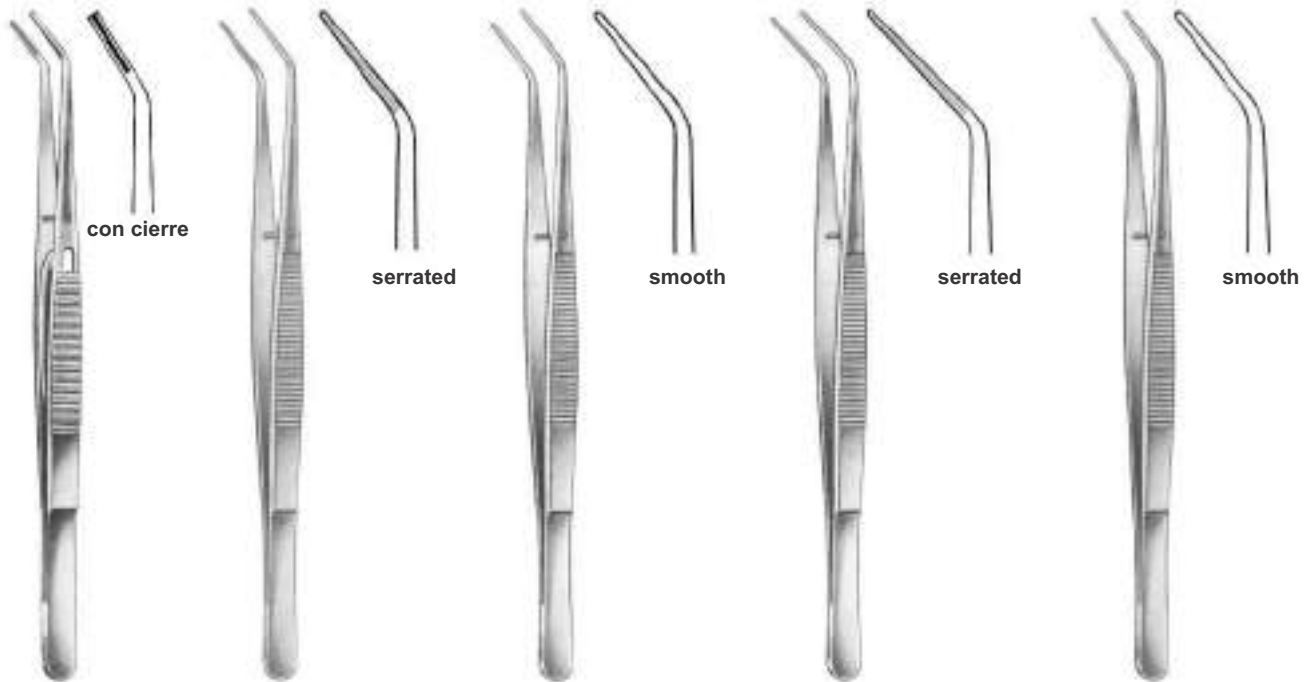

AK-2421
15.5 cm, 6¹/₈"

AK-2422
London-College
15 cm, 6"

AK-2423
London-College
15 cm, 6"

AK-2424
London-College
15 cm, 6"

AK-2425
London-College
15 cm, 6"

Dental Tweezers



AK-2426
CK1
15 cm, 6"

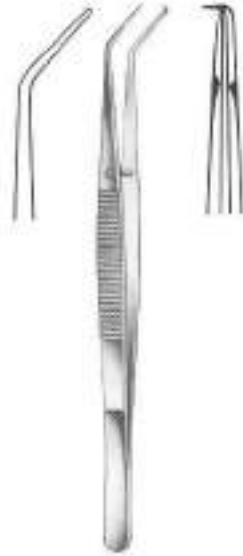

AK-2427
CK2
15 cm, 6"

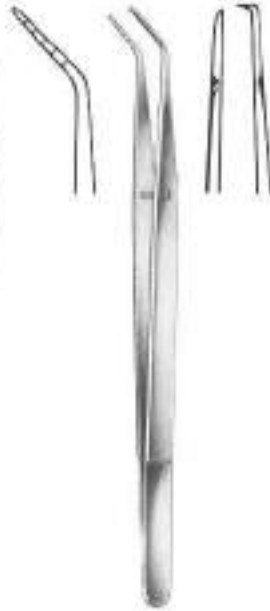

AK-2428
GF2
16 cm, 6 1/4"



AK-2429
Gf1
16 cm, 6 1/4"



AK-2430
Kopp
15.5 cm, 6 1/8"



AK-2431
Kopp
15.5 cm, 6 1/8"



AK-2432
15 cm, 6"



AK-2433
16.5 cm, 6 1/2"



AK-2434
15.5 cm, 6 1/8"



AK-2435
15.5 cm, 6 1/8"

Dental Tweezers



AK-2436
London-College
15 cm, 6"



AK-2437
London-College
15 cm, 6"



con cierre



AK-2438
Meriam
16 cm, 6 1/4"



serrated



smooth



AK-2439
Allen
18 cm, 7 1/8"



AK-2440
Albrecht
16 cm, 6 1/4"



AK-2441
Albrecht
16 cm, 6 1/4"



AK-2442
16 cm, 6 1/4"



AK-2443
16 cm, 6 1/4"



AK-2444
16 cm, 6 1/4"

Rubber Dam Clamp Forceps

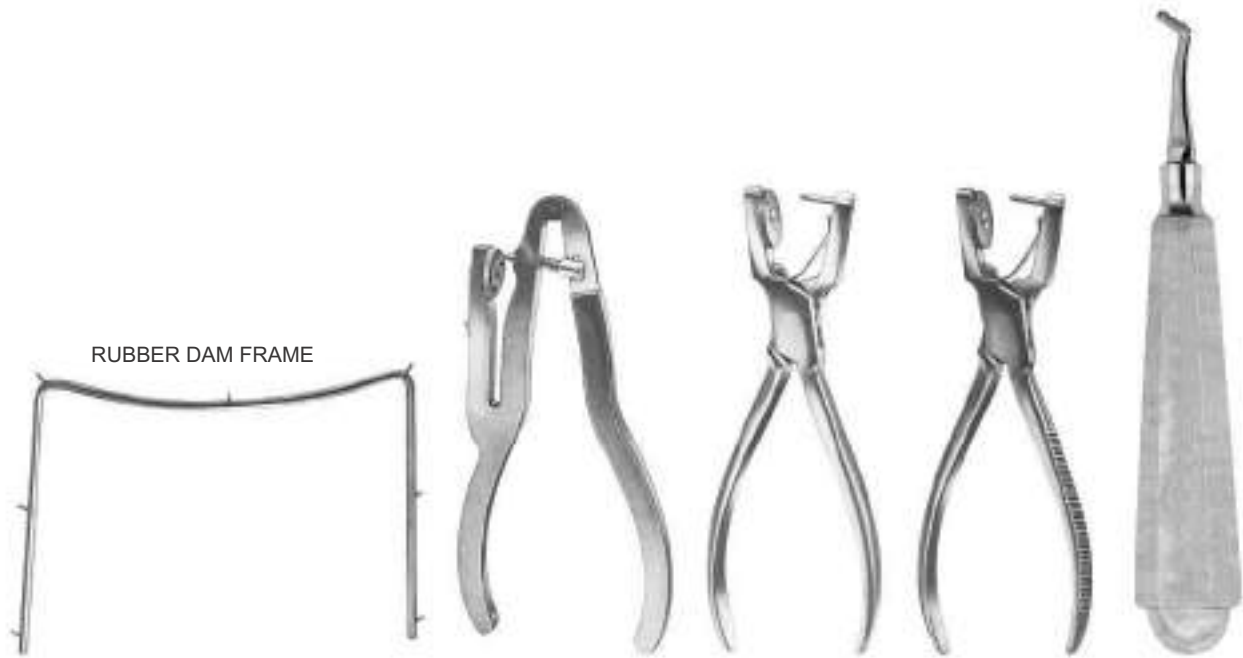

AK-2500
Young
105x95 Inox

AK-2501
Ivory
160 mm

AK-2502
Ainsworth
170 mm

AK-2503
Ainsworth
170 mm

AK-2504
Mershan
140 mm

CLAMPS (PLIERS)

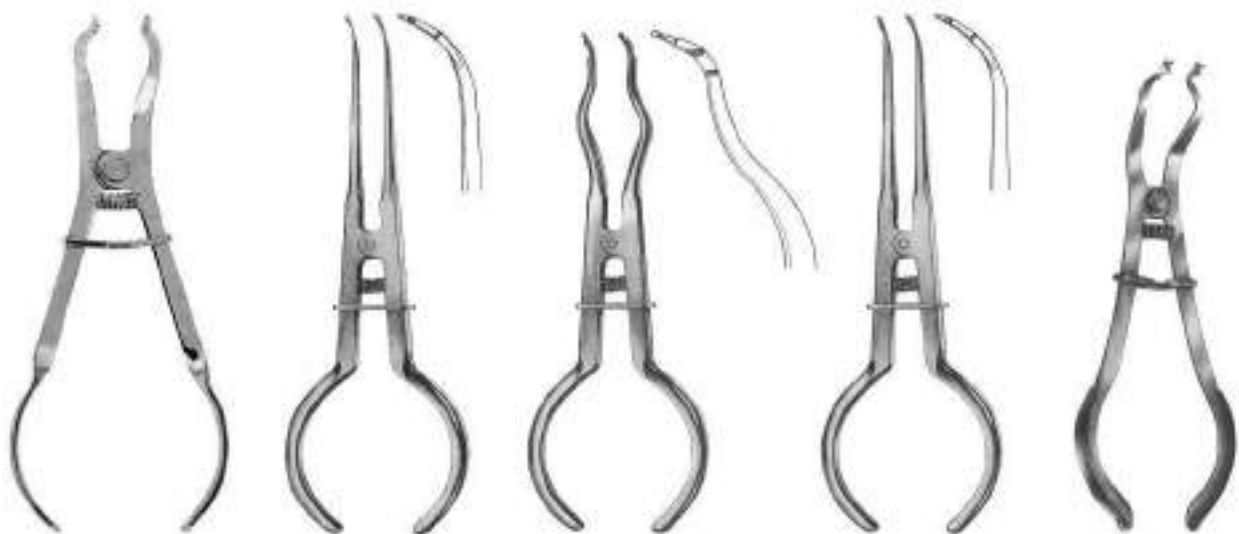

AK-2505
Ivory light weight
170 mm

AK-2506
Brewer
175 mm

AK-2507
Brewer
175 mm

AK-2508
White
175 mm

AK-2509
Ivory
170 mm

Rubber Dam Clamps

Anterior

Premolars



AK-2510
Winged
Labial Clamp



AK-2511
Winged
Edged Labial Clamp



AK-2512
Winged
Cervical Clamp



AK-2513
Winged
Labial Clamp



AK-2514 - 00
Winged



AK-2515 - 0
Winged



AK-2516 - WO
Wingless

For Small Teeth, Elongated or With Narrow Collars



AK-2517 - 1
Winged



AK-2518
Winged



AK-2519
Wingless

For General Use With Adjustable Jaws According To Gingival Line Shapes



AK-2520
Winged



AK-2521
Edged, Winged



AK-2522
Wingless

For Premolars, With Elongated Collar



AK-2523
Winged



AK-2524
Edged, Winged



AK-2525
Wingless

For Premolars, With Elongated Collar



AK-2526
Wingless



AK-2527
Wingless

Rubber Dam Clamps



AK-2528 - 3
Winged

For Small Lower Molars



AK-2529
Wingless



AK-2530
Winged

For Small Lower Molars With Round clamps



AK-2531
Wingless



AK-2532 - 7
Winged

For Square Lower Molars



AK-2533
Wingless



AK-2534 - 8
Winged

For Round Upper Molars



AK-2535
Wingless



AK-2536 - 8A
Winged

For Molar Roots



AK-2537
Wingless



AK-2538
Winged

For Partially Broken Molars



AK-2539
Wingless



AK-2540
Winged

For Round Molars, Partially Broken, Undersized or Inclined



AK-2541
Edged Winged



AK-2542
Wingless



AK-2543
Winged



AK-2544
Wingless



AK-2545
Wingless



AK-2246
Wingless



AK-2547
Winged



AK-2548
Winged



Matrix Retainers and Matrix Bands



2600
Ivory
63mm



AK-2601-1
Tofflemire-Universal



AK-2602
Tofflemire-Junior



AK-2603-3
Tofflemire-Senior



AK-2604
Ivory 8
5 mm



AK-2605
Ivory 8
6 mm



AK-2606
Ivory 8
7 mm



AK-2607
Ivory 8 N



AK-2608
Didner 8 P



AK-2610-7



AK-2611-8



AK-2612-9



AK-2613-10

For Molars and Premolars



AK-2614-11



AK-2615-12



AK-2616-13

AK-1750-5 mm x 100 cm
AK-1750-6 mm x 100 cm
AK-1750-7 mm x 100 cm



2609

Matrix Bands



AK-2617
Molar
Fig 7



AK-2618
Molar
Fig 8



AK-2619
Molar
Fig 9



AK-2620
Molar
Fig 10



AK-2621
Tofflemire



AK-2622
Tofflemire



AK-2623
Tofflemire



AK-2624
Bicuspid



AK-2625
Bicuspid



AK-2626
Bicuspid



AK-2627
Bicuspid



AK-2628
Bicuspid



AK-2629
Bicuspid



AK-2633



AK-2630
Molar



AK-2631
Molar



AK-2632
Molar

Dental Crown Removers



AK-2704
Crown Spreader, Crown Remove.
Special instrument for crown spreading
after separating, simple and safe
operation.



vn Removers, Scissors, Forceps, Amalgum Guns & Carriers



Universal "HM"
12 cm, 4 3/4"



AK-2709



AK-2710



AK-2711
Beebee
10,5 cm, 4 1/8"



AK-2712
Mershon



AK-2713
Morell



AK-2714
Morell



AK-2715
Morell



AK-2716
Morell



AK-2717
Treymann



AK-2718
Automatic Crown Remover
With 2 Points



AK-2719



AK-2720

Amalgam Guns and Carriers



AK-2800
Medium-Large
20 cm

AK-2801
Medium-Jumbo
20 cm

AK-2802
Large-Jumbo
20 cm

AK-2803
Jumbo-Jumbo
20 cm

AK-2804
Medium
15.5 cm

AK-2805
Large
15.5 cm

AK-2806
Jumbo
15.5 cm



Ø 2 mm
AK-2807
Straight
15 cm

Ø 2 mm
AK-2808
15 cm

AK-2809
15 cm

90°



AK-2810
Amalgam Well
Non Skid Base
Ø 3.5 mm

er Ring Romoving Pliers, Paper Articlater Forceps

Copper ring removing pliers



AK-2900
Bohm
11,5 cm



AK-2901
Bohm
14,5 cm



AK-2902
Furrer
16 cm



AK-2903
Furrer
16 cm



AK-2904
Miller
15 cm



AK-2905
Miller
15 cm



AK-2906
Kelly
14 cm



AK-2907
Halstead-Mosquito
12 cm



AK-2908
Micro-Mosquito
10 cm

Rongeurs

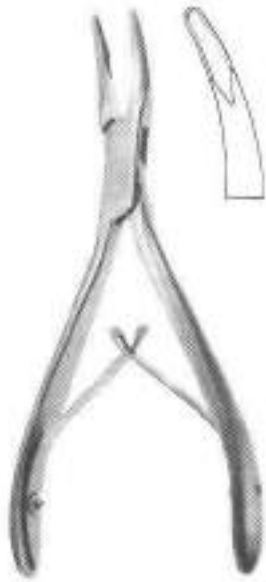

AK-3000
Friedmann
14 cm, 5 1/2"



AK-3001
14 cm, 5 1/2"

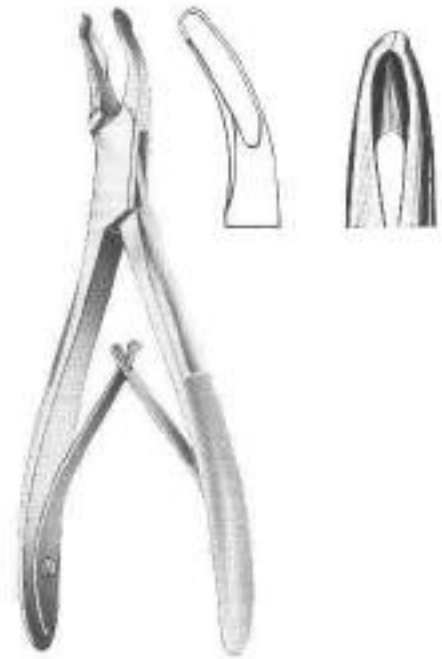

AK-3002
Mead
14 cm, 5 1/2"



AK-3003
Mead
14 cm, 5 1/2"



AK-3004
Mead
17 cm, 6 3/4"



AK-3005
Schell
17 cm, 6 3/4"

Bone Rongeurs



AK-3006
Luer
15 cm



AK-3007
Friedman
14 cm



AK-3008
Mini Friedman
12 cm



AK-3009
Goldman-Fax
10 cm



AK-3010
Blumenthal
15 cm



AK-3011
Blumenthal 45
14,5 cm



AK-3012
Blumenthal 90
14 cm



AK-3013
Bohler
15 cm



AK-3014
Kerrison
15 cm

Rongeurs



AK-3015
Blumenthal
16 cm, 6 1/4"



AK-3016
Blumenthal
16 cm, 6 1/4"



AK-3017
Blumenthal
16 cm, 6 1/4"



AK-3018
Kleinert-Kutz
14 cm, 5 1/2"



AK-3019
Ruskin-Mini
15 cm



AK-3020
Beyer
18 cm, 7 1/8"



AK-3021
Zaufal-Jansen
18 cm, 7 1/8"

Rongeurs



AK-3022
Niro
No. 5 S, 14 cm, 5 1/2"



AK-3023
Cleveland
No. 5 S, 17 cm, 6 3/4"



AK-3024
No. 18, 15 cm, 6"



AK-3025
Cleveland
16 cm, 6 1/4"



AK-3026
Gardner
16 cm, 6 1/4"



AK-3027
Liston-mini
15 cm, 6"

Bone Elevators

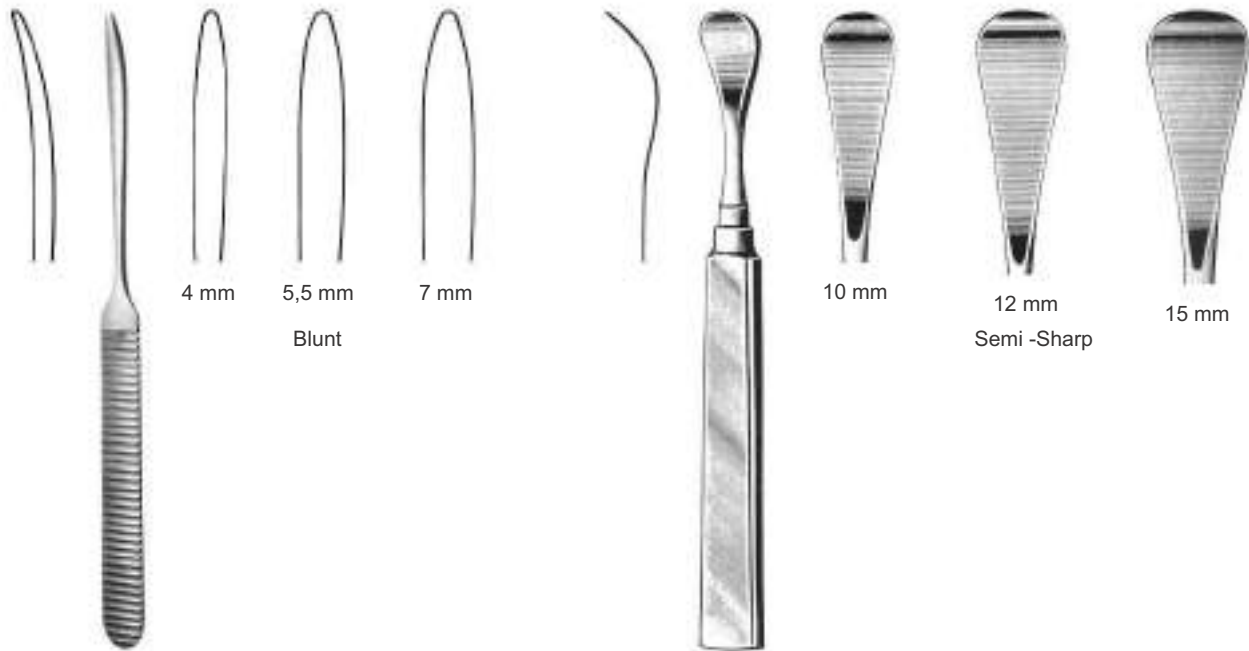

AK-3100
Williger
16 cm, 6 1/4"

AK-3101
Henahan
17 cm, 6 3/4"

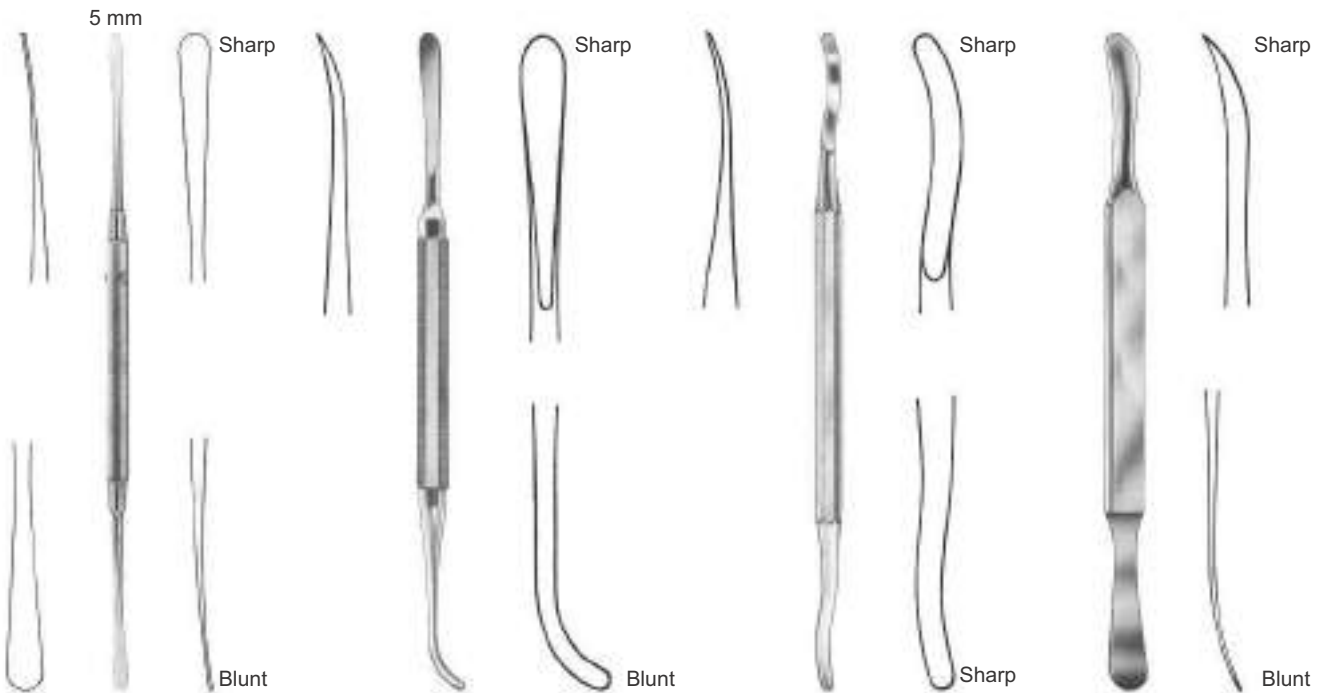

AK-3102
Freer
19 cm, 7 1/2"

AK-3103
Bennet
17 cm, 6 3/4"

AK-3104
Seldin
19 cm, 7 1/2"

AK-3105
Seldin
19,5 cm, 7 3/4"

Bone Files and Chisels



Buckley
15 cm, 6"



AK-3106
No.1
3mm



AK-3107
No. 2
4mm



AK-3108
No. 3
5mm



AK-3109
No. 4
4mm



AK-3110
No. 5
4mm



AK-3111
Killian
16 cm, 6 1/4" 5 mm



AK-3112
Killian-Claus
16 cm, 6 1/4" 5 mm



Obwegeser



AK-3113
2,5 mm



AK-3114
4 mm



AK-3115
Miller
No.10C



AK-3116
Miller
No.11C



AK-3117
Miller
No.12C



AK-3118
Miller
No.13C



Pliers for Orthodontics

Pinze per formare loops
Loops forming pliers



AK-3200
Adams

Adams pliers for bending
wires up to 0,7mm. (.28").



AK-3201
Adams

Adams pliers for bending
wires up to 0,7mm. (.28").



AK-3202
Adams

Tweed loop forming pliers.
For forming loop in wires up
to 0,56 mm. (.22").



AK-3203
Adams

Aderer three jaws bending
pliers. For wires up
to 0,7 mm. (.28").



AK-3204
Adams

Aderer three jaws bending
pliers. For wires upto 0,7 mm.
(.28").

Pliers for Orthodontics

Ligature Cutter Pliers



AK-3205

Micro-miniature light wire cutter. It cuts soft ligature wires. For use in caso of limited access. Caution: maximum cutting capacity: soft ligature wire up to 0,30 mm. (.012").



AK-3206

Wire cutter. For ligature wires and pins. It is strong enough to bend archwire ends after distal cutting. Maximum cutting capacity up to 0,56 x 0,7 mm. (.022" x .028").



AK-3207

Wire cutter. For ligature wires and pins. It is strong enough to bend archwire ends after distal cutting. Maximum cutting capacity: up to 0,9 mm. (.036").



AK-3208

Wire cutter. For ligature wires and pins. It is strong enough to bend archwire ends after distal cutting. Maximum cutting capacity: up to 1,5 mm. (.044").

Pliers for Orthodontics

Pinze per formare laboratorio
Laboratory pliers



AK-3209

Flat nose pliers with smooth beaks for bending wires up to 0,7 mm. (.028").



AK-3210

Bending wires up to 0,7 mm. (.028").



AK-3211

Bending wires up to 0,7 mm. (.028").



AK-3212

Bending wires up to 0,7 mm. (.028").

Pliers for Orthodontics



AK-3213
Nance

Nance loop closing pliers, for bending of stop loops and special for Adams' clasps. Wires up to 0,7 mm. (.028").



AK-3214
Nance

Universal pliers for bending wires up to 0,9 mm. (.035") or cutting up to 0,7 mm. (.028").



AK-3215

Stainless steel pliers tray
standard dimensions



AK-3216
Universal

Universal pin roughening, cutting and bending pliers. For wires up to 0,9 mm. (.035"). Will cut wires up to 0,7 mm. (.028").

Pliers for Orthodontics

Utility and specialty pliers



AK-3217
Reynolds

Reynolds contouring pliers.



AK-3218
Reynolds

Lingual arch pliers used to form double and triple back bends in 0,7 mm (.028") or 0,9 mm (.035") wire for insertion in lingual sheaths.



AK-3219
Weingart

Weingart pliers with serrated points.



AK-3220
De La Rosa

De La Rosa arch forming pliers. Designed to form and contour arch wires on round or rectangular wire. The beak has grooves of 0,4 mm (.016"), 0,46 mm (.018") and 0,56 mm (.022").



AK-3221
De La Rosa

Arch forming pliers with a non grooved contouring surface the forming of precise arches.

Pliers for Orthodontics

Loop formare pliers



AK-3222
Waldsachs

Waldsachs universal pliers for bending wires up to 1,0 mm. (.039") or cutting up to 0,7 mm. (.028").



AK-3223

Round and Concave pliers for loop forming and bending of thin round and square wires up to 0,5 mm. (.020").



AK-3224
Tweed

Tweed loop Forming Pliers. For round or rectangular wires up to 0,56 x 0,7 mm. (.022" x .028"). Replaceable cylindrical beak with three sizes: 1,15 mm. (.045), 1,50 mm. (.059"), 1,90 mm. (.075"). Concave beak with slight parallel serrations, to keep the wire in proper position.



AK-3225
Tweed

Tweed Loop Forming Pliers. For making perfect Omega Loops with round or rectangular wires up to 0,56 x 0,7 mm. (.022" x .028"). The concave beak is exactly the same as pliers 5809-1



AK-3226
Tweed

Single diameter loop forming pliers. Wire up to 0,56 x 0,7 mm. (.022" x 0,28"). Replaceable concave beak has only one diameter section of 1,50 mm. (.059").

Pliers for Orthodontics

Distal end cutters



AK-3227

Distal end cutter -safety hold- a precision cutter designed for distal arch cutting in the patient's mouth. It cuts hard wires end holds the loose distal end preventing any damaging of oral tissue. Maximum cutting capacity rectangular wires up to 0,56 x 0,7 mm. (.022" x .020").



AK-3228

Micro- distal end cutter - safety hold-. Similar to 3227

D.B. bracket remover pliers



AK-3229

Direct bonding bracket remover (wide). The removal grip firmly for easy incisal-gingival (vertical) use or, if needed, for mesial-distal (horizontal) use with the same ease.



AK-3230

Direct bond attachment remover (angled). For removing all bonded attachments. May be used mesial-distal-horizontal) or incisal-gingival (vertical) in anterior areas. Angled perfectly for easy access to difficult posterior areas.

Pliers for Orthodontics

Bird beack pliers



AK-3231

Wire bending pliers. For wires up to 0,9 mm. (.036").



AK-3232

Bird Beak Angle pliers for bending round, square or rectangular wire up to 0,7 mm. (.028").



AK-3233

Double rounded jaw wire bending pliers. For wires up to 0,7 mm. (.028").



AK-3234

Bird beak pliers for bending round, square or rectangular wire up to 0,7 mm. (.028"). With cutter.



AK-3235

Double rounded jaw wire bending pliers. For wires up to 0,7 mm. (.028").

Pliers For Orthodontics and Prosthetics

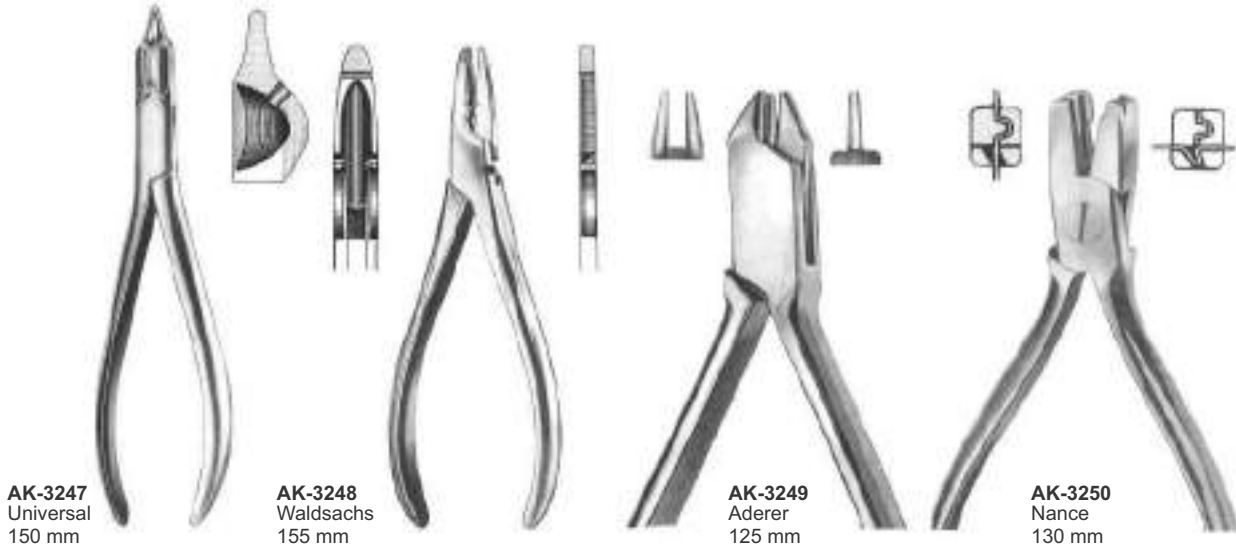
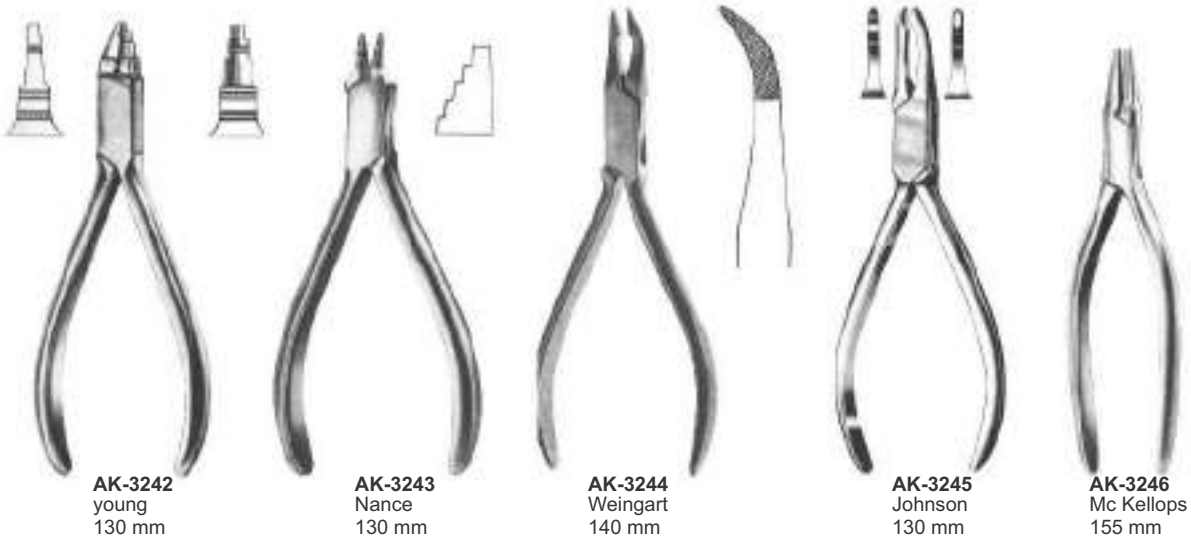
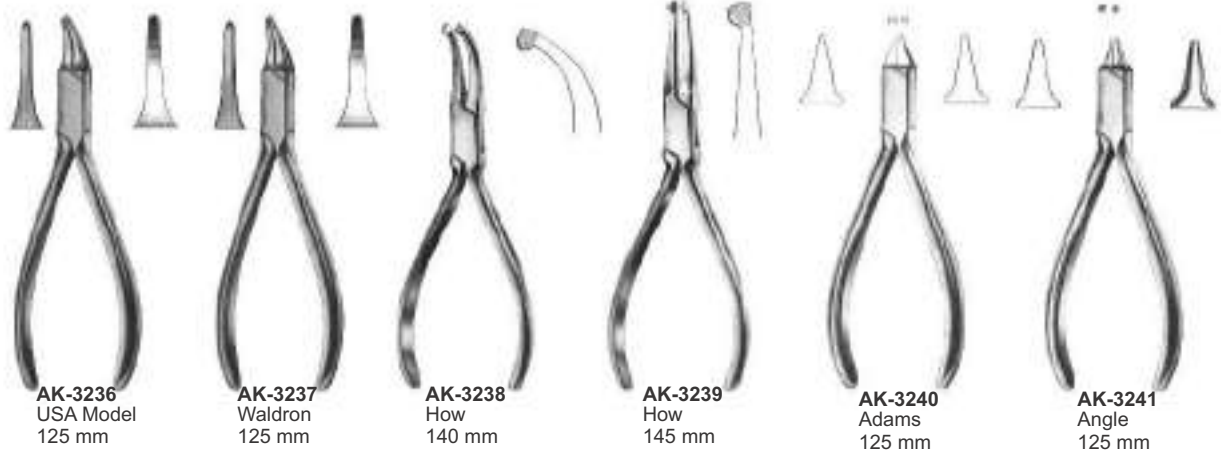

Pliers For Orthodontics and Prosthetics



AK-3251
Langenbeck
140 mm



AK-3252
Langenbeck
130 mm



AK-3253
Langenbeck
130 mm



AK-3254
Peeso
125 mm



AK-3255
Goslee
125 mm



AK-3256
Fischer
140 mm



AK-3257
Andresen
130 mm



AK-3258
Schwarz
130 mm



AK-3259
MSY
130 mm



AK-3260
Langenbeck
125 mm



AK-3262



AK-3263



AK-3264



AK-3265



AK-3266



AK-3267



AK-3268

Pliers For Orthodontics and Prosthetics



AK-3269



AK-3270



AK-3271

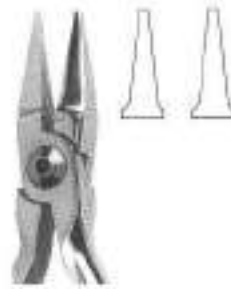

AK-3272



AK-3273



AK-3274



AK-3275



AK-3276



AK-3277



AK-3278



AK-3279



AK-3280



AK-3281



AK-3282



AK-3283



AK-3284



AK-3285



AK-3286

Stainless Steel Impression Trays

All Impression Trays Upper & Lower Type are available in S, M, L & XL Sizes



AK-3300
"HYDRO-LOCK"
stainless steel
water-cooled
impression trays
with retention rim.



AK-3301
"HYDRO-LOCK"
stainless steel
water-cooled impression
trays with retention rim.



AK-3302
"NEW SUPER"
stainless steel
impression trays
with retention rim.



AK-3303
"NEW SUPER" stainless
steel impression trays
with retention rim.



AK-3304
"ANATOMIC" solid
regular stainless
steel impression
trays without
retention rim.



AK-3305
"ANATOMIC" solid regular
stainless steel impression
trays without retention rim.



AK-3306
Perforated-total denture
stainless steel
impression trays with rim.



AK-3307
Perforated-total denture
stainless steel
impression trays with rim.

Stainless Steel Impression Trays

All Impression Trays Upper & Lower Type are available in S, M, L & XL Sizes



AK-3308
"PERMA-LOCK" solid regular stainless steel impression trays with retention rim.



AK-3309
"PERMA-LOCK" solid regular stainless steel impression trays with retention rim.



AK-3310



AK-3311



AK-3312



AK-3313



AK-3314



AK-3315



AK-3316
Set of six

PACKINGS



3317
Set of Eight



AK-3318
Solid stainless steel anterior depressed impression trays with retention rim.



AK-3319



AK-3320



AK-3321



AK-3322



AK-3323



AK-3324



AK-3325
Solid stainless steel anterior depressed impression trays with retention rim.

Stainless Steel Impression Trays

All Impression Trays Upper & Lower Type
are available in S, M, L & XL Sizes



AK-3326
Fig. 0 per bambini - for children



AK-3327
For narrow toothed upper jaws



AK-3328
Fig. 0 per bambini - for children



AK-3329
For partially toothed upper jaws



AK-3330
For partially toothed lower jaws



AK-3331
For edentulous upper jaws



AK-3332
For edentulous lower jaws

Stainless Steel Impression Trays

All Impression Trays Upper & Lower Type are available in S, M, L & XL Sizes



AK-3333
Solid total denture stainless steel impression tray with rim.



AK-3334
Solid total denture stainless steel impression tray with rim.



AK-3335
"PERMA-LOCK" perforated regular stainless steel impression trays with retention rim.



AK-3336
"PERMA-LOCK" perforated regular stainless steel impression trays with retention rim.



AK-3337
Perforated stainless steel anterior depressed impression trays with retention rim.



AK-3338



AK-3339



AK-3340



AK-3341



AK-3342



AK-3343



AK-3344
Perforated stainless steel anterior depressed impression trays with retention rim.



AK-3345
Perforated stainless steel impression trays without retention rim for complete denture.



AK-3346
Perforated stainless steel impression trays without retention rim for complete denture.

Articulators



AK-3400



3401



AK-3402



AK-3403



AK-3404



Articulators



AK-3406



AK-3407



AK-3408



AK-3409

Dental & Surgical Hollowares



AK-3500
ENDODONTIC BOX



AK-3501
STERILIZING BOX
Available in dif. sizes
17x17x3 cm
20x10x4 cm
25x12x6 cm
30x14x6 cm



AK-3502
ENDO TRAY BOX



AK-3503
COTTON DISPENSER



AK-3504
ALCOHOL LAMP

Sterilizing Drums



AK-3505 Small



AK-3506 Medium



AK-3507 Large

Dental & Surgical Hollowares

Sterilizing Boxes



AK-3508



AK-3509



AK-3510

Sterilizing Boxes



AK-3511



AK-3512



AK-3513



AK-3514



AK-3515



AK-3516

FORCEP AND THERMOMETER JARS

COTTON DISPENSER



AK-3517
IRRIGATOR(Douch can)



AK-3518
MEASURING JUG



AK-3519
KIDNEY TRAY



AK-3520
FORCEP JAR



AK-3521
GALLIPOT WITH & WITHOUT LID



AK-3522
SPITTEN MUG



AK-3523
SPIRIT LAMP



AK-3524
Perforated Tray



AK-3525
Perforated Base



AK-3526
Solid Base



AK-3527
Instruments Tray



AK-3528
Instruments Tray



AK-3529
Instruments Tray
(Perforated)



AK-3530
Instruments Tray Shallow
(Mayo)



AK-3531
Scalers Tray



AK-3532
Cathetar Tray

AKCANT

SURGICAL

Dental Instruments

- +92 3131552033
- inquiry@akcantsurgical.com
- www.akcantsurgical.com
- P.O Box 1176 Small Industries Estate, Sialkot Pakistan

